

USER MANUAL

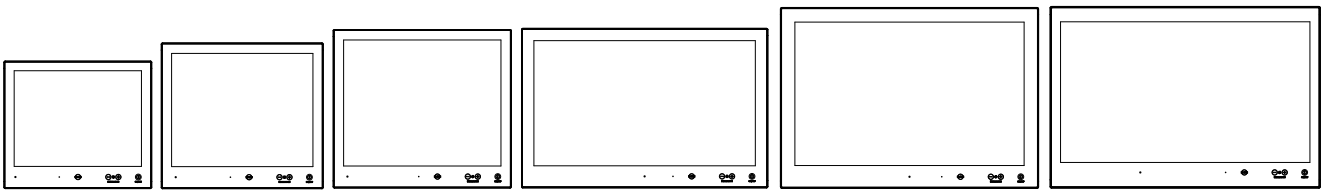

Series X G2 - Maritime Multi Display (MMD) Models

- HD 15T22 MMD-xxx-Fxxx - 15.0 inch Maritime Multi Display
- HD 17T22 MMD-xxx-Fxxx - 17.0 inch Maritime Multi Display
- HD 19T22 MMD-xxx-Fxxx - 19.0 inch Maritime Multi Display
- HD 24T22 MMD-xxx-Fxxx - 24.0 inch Maritime Multi Display
- HD 26T22 MMD-xxx-Fxxx - 25.54 inch Maritime Multi Display
- HD 27T22 MMD-xxx-Fxxx - 27.0 inch Maritime Multi Display

User Manual MMD Series X G2	
Updated: 06 Jan 2021	Doc Id: INB101192-1 (Rev 21)
Created: 363	Approved: 362

Copyright © 2020 Hatteland Technology AS
Eikeskogvegen 52, N-5570 Akksdal, Norway.

All rights are reserved by Hatteland Technology AS. This information may not, in whole or in part, be copied, photocopied, reproduced, translated or reduced to any electronic medium or machine-readable form without the prior written consent of Hatteland Technology AS. Review also: www.hattelandtechnology.com/hubfs/pdf/misc/doc100703-1_permission_to_create_user_manuals.pdf

The products described, or referenced, herein are copyrighted to the respective owners. The products may not be copied or duplicated in any way. This documentation contains proprietary information that is not to be disclosed to persons outside the user's company without prior written consent of Hatteland Technology AS.

The copyright notice appearing above is included to provide statutory protection in the event of unauthorized or unintentional public disclosure.

All other product names or trademarks are properties of their respective owners !

WARNING: This is a class A product. In a domestic environment this product may cause radio interference in which case the user may be required to take adequate measures.

Statement above last revised 31 Jul. 2019

Contents

Contents	3
Contents of package	9
General	11
About this manual	12
About Hatteland Technology	12
www.hattelandtechnology.com	12
Contact Information	12
Maritime Multi Display (MMD) Generation 2 (G2) - Introduction	13
Product Labeling	14
Touch screen products	18
Installation	21
General Installation Recommendations	22
First Things First!	22
Installation and mounting	22
Installation limitations	23
Ergonomics	25
Cables	26
<i>Cable Entries & Connectors (Marked area)</i>	26
<i>Maximum Cable Length</i>	26
Housing / Terminal Block Connector Overview	27
Panel Cutout / Console Mounting Bracket Kit for 15, 17 and 19 inch	29
Panel Cutout / Console Mounting Bracket Kit for 24 and 27 inch	31
Panel Cutout / Console Mounting Bracket Kit for 26 inch	32
Mounting Bracket, Table / Desktop / Ceiling - 15, 17 and 19 inch.....	33
Mounting Bracket, Table / Desktop / Ceiling - 24, 26 and 27 inch.....	35
Physical Connections.....	37

Contents

Operation	41
User Controls	42
On Screen Display (OSD) Menu Introduction	44
OSD Key Code (password) overview.....	44
OSD Keycode / OSD Lock Mode	45
OSD “Basic”, “Advanced” & “Service” Menu modes	46
OSD Visual Feedback (examples).....	46
OSD Menu Structure.....	47
<i>Input Source Settings</i>	47
<i>Image Settings</i>	47
<i>Color Mode Settings</i>	48
<i>Multi-PIP Settings</i>	48
<i>OSD Miscellaneous</i>	49
<i>Management Settings</i>	50
<i>Service Settings</i>	51
On Screen Display (OSD) Menu Functions	52
Operation Advanced (DDC/CI)	79
Introduction	80
Specifications	83
Specifications - HD 15T22 MMD-xxx-Fxxx	84
Specifications - HD 15T22 MMD-xxx-FHxx.....	85
<i>High Bright model</i>	85
Specifications - HD 17T22 MMD-xxx-Fxxx	86
Specifications - HD 17T22 MMD-xxx-FHxx.....	87
<i>High Bright model</i>	87
Specifications - HD 19T22 MMD-xxx-Fxxx	88
Specifications - HD 19T22 MMD-xxx-FHxx.....	89
<i>High Bright model</i>	89
Specifications - HD 24T22 MMD-xxx-Fxxx	90
Specifications - HD 24T22 MMD-xxx-FHxx.....	91
<i>High Bright model</i>	91
Specifications - HD 26T22 MMD-xxx-Fxxx	92
Specifications - HD 27T22 MMD-xxx-Fxxx	93

Contents

Technical Drawings	95
Technical Drawings - HD 15T22 MMD-xxx-Fxxx.....	96
Technical Drawings - HD 15T22 MMD-xxx-FHxx.....	97
<i>High Bright model</i>	97
Technical Drawings - HD 17T22 MMD-xxx-Fxxx.....	98
Technical Drawings - HD 17T22 MMD-xxx-FHxx.....	99
<i>High Bright model</i>	99
Technical Drawings - HD 19T22 MMD-xxx-Fxxx.....	100
Technical Drawings - HD 19T22 MMD-xxx-FHxx.....	101
<i>High Bright model</i>	101
Technical Drawings - HD 24T22 MMD-xxx-Fxxx.....	102
Technical Drawings - HD 24T22 MMD-xxx-FHxx.....	103
<i>High Bright model</i>	103
Technical Drawings - HD 26T22 MMD-xxx-Fxxx.....	104
Technical Drawings - HD 27T22 MMD-xxx-Fxxx.....	105

Contents

Technical Drawings - Accessories	107
Technical Drawings - HD TMB SX2-A1	108
<i>Desktop/Table Mounting Bracket 15 inch</i>	108
Technical Drawings - HD TMB SX2-A1	109
<i>Desktop/Table Mounting Bracket 17 inch</i>	109
Technical Drawings - HD TMB SX2-A1	110
<i>Desktop/Table Mounting Bracket 19 inch</i>	110
Technical Drawings - HD TMB SX1-C1.....	111
<i>Desktop/Table Mounting Bracket 24/26/27 inch</i>	111
<i>Desktop/Table Mounting Bracket 24 inch</i>	112
<i>Desktop/Table Mounting Bracket 26 inch</i>	113
Technical Drawings - HD CMB SX2-A1	114
<i>Console Mount Bracket</i>	114
Technical Drawings - HD CMB SX2-A1	115
<i>Console Mount Kit 15 inch</i>	115
Technical Drawings - HD CMB SX2-A1	116
<i>Console Mount Kit 17 inch</i>	116
Technical Drawings - HD CMB SX2-A1	117
<i>Console Mount Kit 19 inch</i>	117
Technical Drawings - HD CMB SX2-E1	118
<i>Console Mount Kit 24 inch</i>	118
<i>Console Mounting 24 inch</i>	119
<i>P006801-1 Flush Mounting 24 inch</i>	120
Technical Drawings - HD CMB SX2-F1.....	121
<i>Console Mount Kit 26 inch</i>	121
<i>Console Mounting 26 inch</i>	122
<i>P007084-1 Flush Mounting 26 inch</i>	123
Technical Drawings - HD CMB SX2-E1	124
<i>Console Mount Kit 27 inch</i>	124
<i>Console Mounting 27 inch</i>	125
<i>P020721 - Flush Mounting 27 inch</i>	126
Technical Drawings - HD VED SX2-A1	127
<i>VESA Adapter 15 inch</i>	127
Technical Drawings - HD VED SX2-B1	128
<i>VESA Adapter 17 inch</i>	128
Technical Drawings - HD VED SX2-C1.....	129
<i>VESA Adapter 19 inch</i>	129
Technical Drawings - HD VED SX2-I1	130
<i>VESA Adapter 24 inch</i>	130
Technical Drawings - HD VED SX2-J1.....	131
<i>VESA Adapter 26 inch</i>	131

Contents











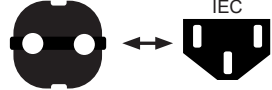

Technical Drawings - HD VED SX2-K1	132
<i>VESA Adapter 27 inch</i>	132
Technical Drawings - JH 15TAP STD-C1	133
<i>15 inch Series X to fit 15 inch Series 1 Console Cutout</i>	133
Technical Drawings - JH 19TAP STD-C1	134
<i>19 inch Series X to fit 19 inch Series 1 Console Cutout</i>	134
Technical Drawings - HD 19TAP SX2-C2	135
<i>19 inch Series X to fit 19 inch Series 2 Console Cutout</i>	135
Technical Drawings - JH 26TAP STD-A1	137
<i>26 inch Series X to fit 26 inch Series 1 Console Cutout</i>	137
Technical Drawings - HD 26TAP SX1-A1.....	138
<i>26 inch Series X to fit 27 inch Series 1 Console Cutout</i>	138
Technical Drawings - HD 15COV SX1-A1.....	139
<i>UV Sun Cover (15 inch)</i>	139
Technical Drawings - HD 17COV SX1-A1.....	140
<i>UV Sun Cover (17 inch)</i>	140
Technical Drawings - HD 19COV SX1-A1.....	141
<i>UV Sun Cover (19 inch)</i>	141
Technical Drawings - HD 24COV SX1-A1.....	142
<i>UV Sun Cover (24 inch)</i>	142
Technical Drawings - HD 26COV SX1-A1.....	143
<i>UV Sun Cover (26 inch)</i>	143
Technical Drawings - HD 27COV SX1-A1.....	144
<i>UV Sun Cover (27 inch)</i>	144
Technical Drawings - HD CAK SX2-A1	145
<i>Front Console Mounting/Adapter Kit (24 inch)</i>	145
Technical Drawings - HD CAK SX2-B1	146
<i>Front Console Mounting/Adapter Kit (27 inch)</i>	146
Technical Drawings - P006997-1	147
<i>IP66 Panel Gasket (15 inch)</i>	147
Technical Drawings - P007130-1	148
<i>IP66 Panel Gasket (17 inch)</i>	148
Technical Drawings - P007131-1	149
<i>IP66 Panel Gasket (19 inch)</i>	149
Technical Drawings - P022211	150
<i>IP66 Panel Gasket (24 inch)</i>	150
Technical Drawings - P007178.....	151
<i>IP66 Panel Gasket (26 inch)</i>	151
Technical Drawings - P018743.....	152
<i>IP66 Panel Gasket (27 inch)</i>	152
Technical Drawings - HD REM SX1-A1	153
<i>For External Mounting</i>	153

Contents

Appendixes	155
UHF Interference Prevention	156
Pinout Assignments.....	158
Basic Trouble-shooting.....	161
Declaration of Conformity.....	162
Return Of Goods Information	163
General Terms and Conditions.....	164
Pixel Defect Policy	165
Notes.....	166
Revision History	168

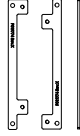
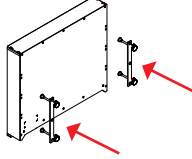
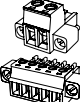

Contents of package

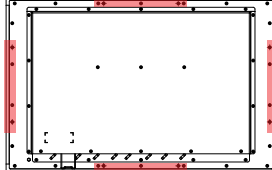
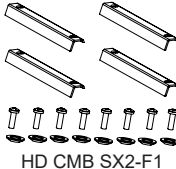
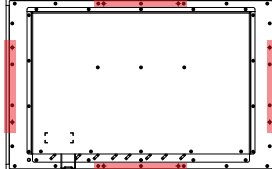
Note: Entries listed below are for Standard factory shipments. Customized factory shipments may deviate from this list.

Item	Description	Illustration
 HA-SDM-2M	1 x Standard DVI Signal Cable. DVI-D 18+1P Male to DVI-D 18+1P Male Single Link - Length 2.0m	
 HA-VGA-2M-32	1 x Standard VGA Signal Cable. DSUB 15P Male to DSUB 15P Male - Length 2.0m	
 TP52/TC01-1,8M	1 x Power Cable (Black) European Type F "Schuko" to IEC. Length 1.8m <i>Note: Included in package for models with AC input.</i>	EUR TYPE F 
 TP11/TC01-1,8M	1 x Power Cable (Black) US Type B plug to IEC. Length 1.8m <i>Note: Included in package for models with AC input.</i>	US TYPE B 
 DVI-4	1 x DVI-I > RGB/VGA adapter DVI-I 24+5P (Dual Link) Male to DSUB 15P Female	
	Test Report	
 HD CMB SX2-A1	Model Dependent: 2 pcs of Mounting Brackets for Console/Panel Mounting, Anodized Aluminium/Stainless Steel. The bracket kit is suitable for 15, 17 and 19 inch units and is EN60945 Tested (pending). Suitable for panel thickness min: 2.0 [0.08"] to max: 50.00 [1.97"] mm [inch].	
 Terminal Block Connector Kit	Terminal Block Connector Kit as follows (may in some cases be already factory mounted): 1 x 2-pin Terminal Block 5.08 for DC Power In 2 x 5-pin Terminal Block 3.81 for RS-422 / RS-485 / SCOM / Buzzer Module Refer to "Configuring Housing / Terminal Block Connector" section for usage.	 Note: Location of module(s) may differ between unit sizes
 HD CMB SX2-E1	Model Dependent: Bracket Kit suitable for console/panel mounting which contains: 3 x Mounting Bracket for top, left and right side (P006858-1) 1 x Mounting Bracket for bottom side (terminal/connector plate area) (P020605) 6 x M5x16 Pan Head screw ISO 14583 Torx, A4 screws (145 050x016 A4T) 6 x M6 C-washers DIN6319 Steel (144 064x120x22) 2 x DIN 965 M5x16 Countersunk head screws with TX25, A4 STAINLESS STEEL (145 050x016 CA4) Suitable only for 24 and 27 inch units and is EN60945 Tested.	
 HD CMB SX2-F1	Model Dependent: Bracket Kit suitable for console/panel mounting which contains: 4 x Mounting Bracket for top, left, right and bottom side (P007085-1) 8 x Panskruer M5x16 Torx, blank (145 050X016 ZT) 8 x M6 C-washers DIN6319 Steel (144 064x120x22) Suitable only for 26 inch units and is EN60945 Tested.	

Contents of package

Package may also include:

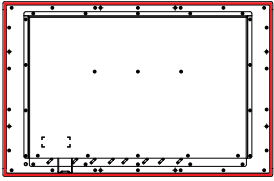
Item	Description	Illustration
 <p>VSD100913-1</p>	<p>1 x Touch Screen Cable (Black) USB Type A to Type A. Length Approx 2m.</p> <p><i>Only included in package if model is equipped with factory mounted Touch Screen</i></p>	
	<p>For models (15-27 inch) an EPDM sealing gasket for IP66 console mount may be factory pre-mounted / included with delivery if ordered. For High Bright models, it is pre-mounted by factory default.</p> <p>Details / Type number reference: Surface: RAL9011, Glue: 3M9471LE, Thickness 2mm. P006997-1 (15), P007130-1 (17), P007131-1 (19) P022211 (24), P007178 (26), P018743 (27)</p>	



General

About this manual

The manual contains electrical, mechanical and input/output signal specifications. All specifications in this manual, due to manufacturing, new revisions and approvals, are subject to change without notice. However, the last updated and revision date of this manual are shown both on the frontpage and also in the "Revision History" chapter. This user manual is a standard/general manual that applies to all variations of its product family, i.e. deviation from actual configuration may exist.

About Hatteland Technology

Hatteland Technology is the leading technology provider of specialized display and computer products, delivering high quality, unique and customized solutions to the international maritime, naval and industrial markets.

The company represents innovation and quality to the system integrators worldwide. Effective quality assurance and investment in sophisticated in-house manufacturing methods and facilities enable us to deliver Type Approved and Mil tested products. Our customer-oriented approach, technical knowledge and dedication to R&D, makes us a trusted and preferred supplier of approved solutions, which are backed up by a strong service network.

www.hattelandtechnology.com

You will find our website full of useful information to help you make an informed choice as to the right product for your needs. You will find detailed product descriptions and specifications for the entire range on Displays, Computers and Panel Computers, Military solutions as well as the range of supporting accessories. The site carries a wealth of information regarding our product testing and approvals in addition to company contact information for our various offices around the world, the global service locations and the technical help desk, all ensuring the best possible support wherever you, or your vessel, may be in the world.

Contact Information

<p>Head office, Aksdal / Norway: Hatteland Technology AS Eikeskogvegen 52 N-5570 Aksdal, Norway</p> <p>Switchboard: Tel: +47 4814 2200 mail@hattelandtechnology.com</p>	<p>Sales office, Frankfurt / Germany: Hatteland Technology GmbH Werner Heisenberg Strasse 12, D-63263 Neu-Isenburg, Germany</p> <p>Uwe Scheumann: Tel: +45 2463 9565</p> <p>Elke Freisens: Tel: +49 173 6174753</p>
<p>Sales office, Oslo / Norway: Hatteland Technology AS Strandveien 35 N-1366 Lysaker Norway</p> <p>Switchboard: Tel: +47 4814 2200 mail@hattelandtechnology.com</p>	<p>Sales office, Aix-en-Provence / France: Hatteland Technology SAS Actimart- 1140, rue Ampère, CS 80544 13594 Aix-en-Provence, Cedex 3 France</p> <p>Mehdi Bounoua (Sales Director Europe, Middle East & Africa): Tel : +33 6 88 33 64 93</p>
<p>Sales office, Vista / USA: Hatteland Technology Inc 450 South Melrose Drive, Suite #107 Vista, CA 92081 USA</p> <p>Donna Pallonetti: Tel: +1 858-282-0659 Fax: +1 858-408-1834</p>	

For an up-2-date list, please visit <https://www.hattelandtechnology.com/contact>

Displays Series X Generation 2 (G2)

Maritime Multi Display (MMD) Generation 2 (G2) - Introduction

As a leading manufacturer of display and computer hardware for the maritime segment, Hatteland Technology continuously gauges and responds to market needs. Our commitment to develop specialized products for a multitude of onboard ship systems continues with Series X. Their compact and sleek design allows them to be desk mount or console integrated. The design is modular, allowing for common modules to be used in various models and combinations. Together these design features bring about a range perfectly in synch to market cost expectations - along with that, the performance and type approval always expected in all Hatteland Technology products.

All sizes are available in display or panel computer formats, as well as various performance specifications to choose from. There are standard base models available which are listed in the following pages. The modules used in Series X, are all qualified having undergone and passed our extensive test program, which includes HALT testing. This means that the products are tested well outside the requirements in EN60945 and E10.

The result is a more reliable product.

In 2017, advancements for the Series X generation two MMD (Maritime Multi Displays) have been rolled out across the 15, 17, 19, 24, 26 and 27 inch models. For users, there is an improved Glass Display Control™ (GDC), GDC backlight uniformity and higher brightness for high luminance environments. For engineers and installers, amongst the developments include improved serviceability, allowing for better access to key components. There is also a new table/ceiling mounting solution for the 15, 17 and 19 inch models.

- MULTITOUCH
- TYPE APPROVED
- ECDIS COMPLIANT
- IP22 REAR / IP66 FRONT
- SUPERIOR BONDING TECHNOLOGY
- MODULE BASED, TAILOR-MADE SYSTEMS MADE EASY!
- SUNLIGHT READABLE / HIGH BRIGHT VERSIONS AVAILABLE
- GLASS DISPLAY CONTROL™ (GDC), SOLID STATE MENU SYSTEM

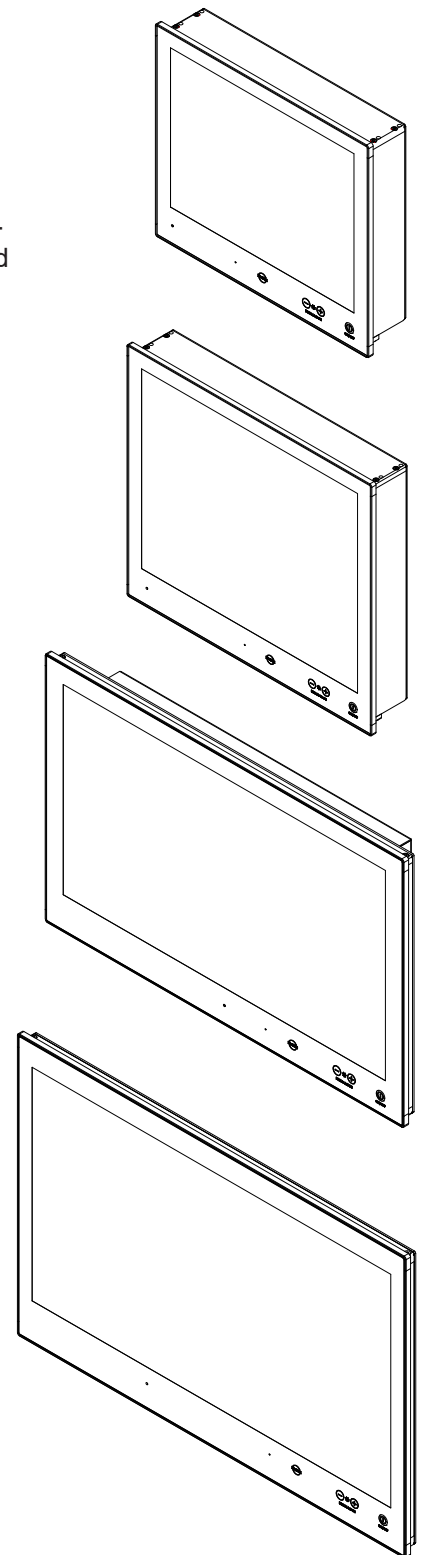





Product Labeling

Introduction

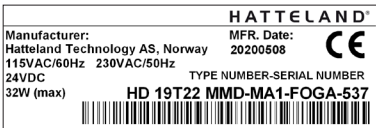
This section details the locations, content details and specifications for factory mounted labels for all currently available standard Hatteland Technology Maritime Multi Display (MMD) models. This information will in most cases also apply for most Customized Models as well, but may differ based on customer requirements, in that case, please refer to the customized User Manual (paper or electronic version, dependent on customer requirements).

Label Size and Types

ID	Label Layout	Description	Specification
1	 <p>Please note that typenumber shown above is a generic sample only. May not reflect products mentioned in this manual. Please review actual product S/N label.</p>	<p>Type : Serial Number Label Name : Label B Size : 60mm wide x 20mm high (rectangle size) Note: Text content of label will match specifications derived from Datasheet.</p>	Silver with glue on back, non-tearable and made for thermal transfer printing.
3		<p>Type : Touch Screen Label Name : Label B Size : 60mm wide x 20mm high (rectangle size) Note: Only present if Touch Screen was part of factory option order.</p>	Silver with glue on back, non-tearable and made for thermal transfer printing.
4		<p>Type : Warranty Label Size : 30mm wide x 23mm high (oval size)</p>	Tamper-proof sticker with glue on back.
5		<p>Type : Quality Control (QC) Label Size : 30mm wide x 23mm high (oval size)</p>	Ordinary sticker with glue on back.

Product Labeling

Label Locations

Number ID and coloring based on “Label Size and Types” table from previous page. All illustrations below are seen from rear (and side where needed) with connectors facing down. Actual labels regarding its size and text orientation vs product size is drawn in. Due to space restrictions on selected units, some labels will be rotated 90 degrees to fit properly. The arrangement of labels may be shifted/stacked differently as it is based on factory options, such as; Touch Screen, but they will be grouped together where possible.

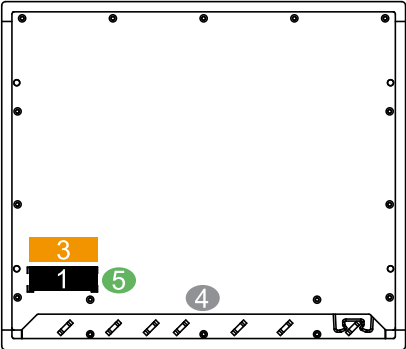
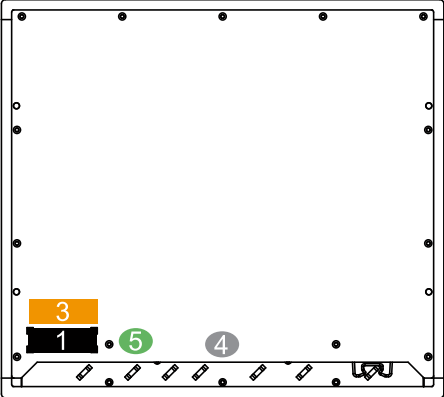
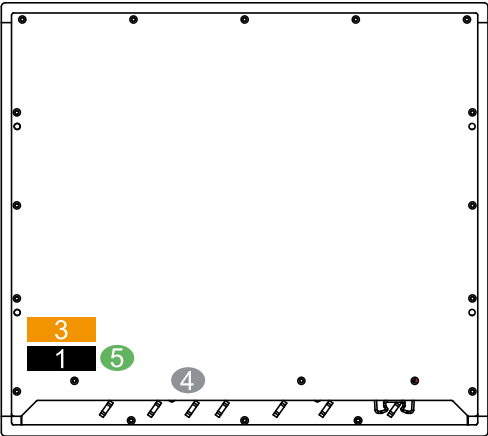
Label Positions	Notes	Applies for Product Range
	<p>Warranty label covers screw. Labels placed on rear.</p>	<p>HD 15T22 MMD-xxx-Fxxx</p>
	<p>Warranty label covers screw. Labels placed on rear.</p>	<p>HD 17T22 MMD-xxx-Fxxx</p>
	<p>Warranty label covers screw. Labels placed on rear.</p>	<p>HD 19T22 MMD-xxx-Fxxx</p>

Product Labeling

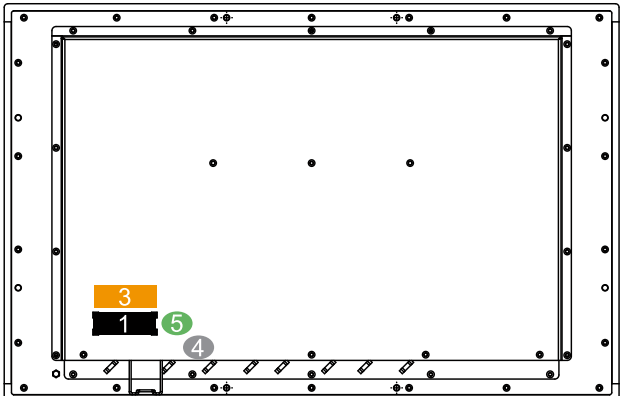
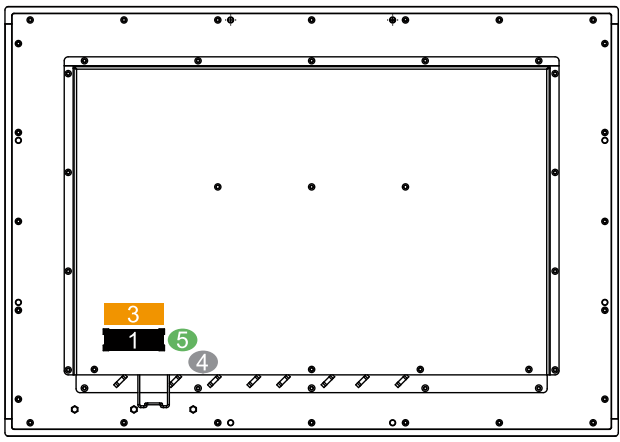
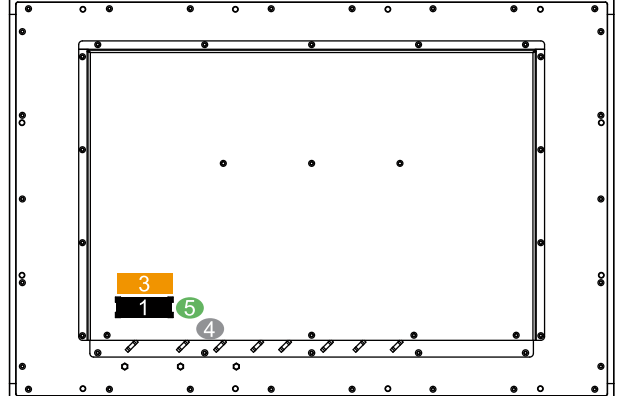
	<p>Warranty label covers screw. Labels placed on rear.</p>	<p>HD 24T22 MMD-xxx-Fxxx</p>
	<p>Warranty label covers screw. Labels placed on rear.</p>	<p>HD 26T22 MMD-xxx-Fxxx</p>
	<p>Warranty label covers screw. Labels placed on rear.</p>	<p>HD 27T22 MMD-xxx-Fxxx</p>

Product Labeling

Warranty Label

If you are to perform service on a unit still under warranty, any warranty will be void if this label shows signs of removal attempts or damaged by screw driver. This label is located on the back of the product and covers a key screw. This is to aid service departments in determining if there has been any unauthorized service on a unit still under warranty.

Quality Control (QC) Label

This label indicates that the unit is produced, tested and packed according to the manufacturer's QA specifications. It will include a Personal ID and signature by the personnel responsible for approving the unit in production, testing and warehouse departments.

Serial Number Label Layout (example)

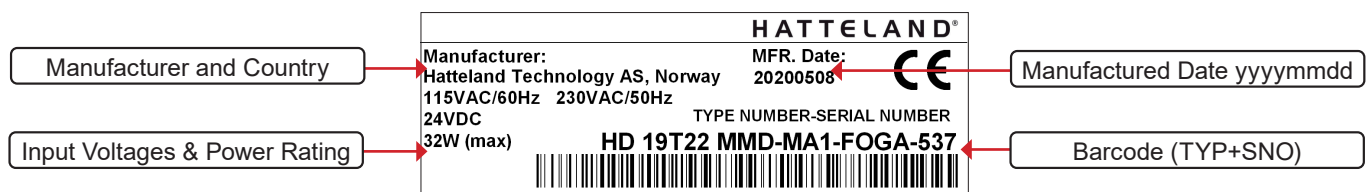

Please note that typenumber shown above is a generic sample only. May not reflect products mentioned in this manual. Please review actual product S/N label.

Touch screen products

Introduction to products with touch screen

Nearly all of our products with touch screen use Projected Capacitive Touch screen (PCTS), widely used with great success on mobile phones and typical pad devices. PCTS can be equally effective also for marine applications. One of the advantages of PCTS is that it has features seen in both resistive and surface capacitive touch screen technologies.

Multitouch is defined as the ability to recognize two or more simultaneous touch points. Using projected capacitive technology allows us to create a more intuitive form of human-device interaction. Touch interface gestures, supported by projected capacitive sensors, can simplify the interface and provide an intuitive user experience that goes beyond the typical "button replacement" found in most simple touch interfaces.

Please review the appropriate Product Datasheet (in this manual) to determine if PCTS are supported and/or its advanced features of additional touch methods (example Tactor and Active Stylus Pen) are available.

The technical benefits of PCTS are:

- Very good optical performance (same as surface capacitive)
- Environmentally strong, the touch sensor is inside the product (better than both surface capacitive and resistive)
- Supports Multitouch (Newer Operating System (OS) required in most cases.
- Excellent readability - light transmission of up to 91% through a standard sensor
- Stability - no drift, therefore no recalibration is required
- Pointing device - works with gloved and ungloved finger
- Resistance to contamination - by harsh cleaning fluids and other noxious substances
- Communicates via USB to external computer or internally

Comparisons between general Touch Technologies used by Hatteland Technology:

Technology	Optical Performance	Gloves	Water	Durability	Multitouch	Stylus	Objects (Tactor)
Analog Resistive	--	++	++	-	-	-	--
Surface Capacitive	++	--	-	+	-	-	--
Projected Capacitive	++	+	+*	++	++	++	++

*Projected Capacitive (PCTS) / Water: Touch Screen Glass Surface can withstand drip and direct rain, but expect reduced capability, detection and performance if units are exposed to these factors while powered. Hatteland Technology recommends protecting the unit from direct rain or drips if critical touch operations are to be performed. Take necessary steps (if detected or suspected) within the installation environment to prevent accidental touch gestures or presses not performed intentionally by a human operator.

Touch Screen Drivers

All units with Touch Screens are automatically detected by the Operating System via HID. There is no need to install additional Third-Party touch screen drivers.

Microsoft® Windows® Svr Emb Std 2012 / Microsoft® Windows® 7 / Microsoft® Windows® 10 IoT:

- Please use Windows® Generic HID driver, no specific driver needed to use multi-touch.
- Alternative configuration available: See “Mouse Mode feature” below.

Microsoft® Windows® XP:

Ref: OS End-of-Life:

<https://www.hattelandtechnology.com/product-notifications/update-eol-microsoft-windows-xp-professional-for-embedded-systems-and-microsoft-windows-xp-embedded>

- Multi-Touch Screen is not supported for this Operating System.
- Alternative Single Touch / Mouse Mode is however supported via alternative parameter files.

Ref: <https://www.hattelandtechnology.com/product-notifications/new-touchscreen-solution-series-x-g2-mmd-15-17-19-inch>

Information, Tools and Parameters files can be downloaded from:

https://www.hattelandtechnology.com/hubfs/drivers/t22_singletouch_mousemode_tools_and_parameters.zip

If you experience any deviation in the touch input accuracy, consider re-calibrating the touch screen for your system. Please use the standard Operating System functionality to calibrate.

Example for Microsoft® Windows® 10 IoT:

1. Open Control Panel.
2. Click on Hardware and Sound.
3. Under “Tablet PC Settings,” click the Calibrate the screen for pen or touch input link.
4. Under “Display options,” select the display (if applicable).
5. Click the Calibrate button.
6. Select the Touch input option

Example for Microsoft® Windows® 7:

- 1: Open Control Panel
- 2: Open “Tablet PC Settings”
- 3: Under “Display options,” select your display.
- 4: Click the Calibrate button and follow instructions
- 5: To save settings, click “Apply” or “OK” on the “Table PC Settings” window.

Mouse Mode feature:

The Multi-Touch screen interface can be configured to support mouse emulation to support certain legacy software. If your system and its GUI (Graphical User Interface) experience lack of response to gadgets/buttons pressed via touch screen, the package below might help. This feature works from **Microsoft® Windows® XP** and up. Please note that Multi-touch will be disabled and replaced by Single Touch mode.

https://www.hattelandtechnology.com/hubfs/drivers/t22_singletouch_mousemode_tools_and_parameters.zip

ref: <https://www.hattelandtechnology.com/product-notifications/new-touchscreen-solution-series-x-g2-mmd-15-17-19-inch>

Linux

- Please use Linux Generic Touch driver.

Note: Kernel before 2.6.38: Single touch support.

Note: Kernel above 2.6.38: Multi touch support.

Note: For optimal graphical performance/hardware support with Skylake/Kaby Lake CPU's on T22 MMC units, the Linux Kernel 4.4 or later is required/recommended.

This page left intentionally blank



Installation

General Installation Recommendations

First Things First!

IND100148-5 - Rev 05

ATTENTION!
To prevent damage to chassis and glass, please review the illustrations !

CORRECT HANDLING!

Place horizontally on a smooth and clean surface (table with cloth)

WRONG HANDLING!

Do not stress the corners, nor place it on a coarse and/or dirty surface

Humidity Exposure Notice!
Applies for non-bonded product only: If exposed to humidity in combination with temperature variations, product might show condensation on the glass (inside and outside).
Inside condensation can be removed by power on the product and set brightness to 100%. During minutes the internal temperature rise will remove condensation.

Installation and mounting

1. Most of our products are intended for various methods of installation or mounting (panel mounting, bracket mounting, ceiling/wall, console mounting etc.); for details, please see the relevant mechanical drawings.
2. Adequate ventilation is a necessary prerequisite for the life of the product. The air inlet and outlet openings must definitely be kept clear; coverings which restrict ventilation are not permissible.
3. Generally, do not install the unit in a horizontal position (laying down), as this will cause heat to build up inside the unit which will damage the LCD Panel. To prevent this problem we recommend installing the unit in a vertical position (± 30 degrees) to improve the airflow through the unit.
4. To further improve the thermal situation we recommend using forced air passing by the product. In some cases, convection based cooling can create "heat zones" around the product. This may be required in high temperature applications and also when there is reason to expect temperature problems due to non-optimal way of mounting.
5. Exposure to extreme direct sunlight can cause a considerable increase in the temperature of the unit, and might under certain circumstances lead to excessive temperature. This point should already be taken into consideration when the bridge equipment is being planned (sun shades, distance from the windows, ventilation, etc.). To maximize product life, it is recommended using Hatteland Technology's UV Sun Covers when the product is not in use. Long term direct sun exposure might have cosmetic impacts on the product.
6. Space necessary for ventilation, for cable inlets, for the operating procedures and for maintenance, must be provided.
7. If the push buttons of the product are not illuminated, an external, dimmable illumination (IEC 60945 Ed. 4, 4.2.2.3, e.g. Goose neck light) is required for navigational use. The illumination should be free from glare and adjustable to extinction.

General Installation Recommendations

8. Information about necessary pull-relievers for cables is indicated in the Physical Connection section of this manual. Attention must be paid to this information so that cable breaks will not occur, e.g. during service work.
9. Do not paint the product. The surface treatment influences the excess heat transfer. Painting, labels or other surface treatments that differ from the factory default, might cause overheating.
10. Exposure to heavy vibration and acoustic noise might under certain circumstances affect functionality and expected lifetime. This must be considered during system assembly and installation. Mounting position must be carefully selected to avoid any exposure of amplified vibration.

Installation limitations

Due to environmental factors, please review the points noted below.

A: Overheat prevention:

For Maritime Multi Computer (MMC, Panel Computers) it is advised that you do not mount the unit in a vertical angle lower than ± 30 degrees, as noted in point 3 (previous section), i.e. flat mounting of the unit. This is to prevent both overheating the unit as well as ensure proper cooling airflow to sustain long-life and stable operation. Panel Computer units generate more heat than regular Display units naturally because of CPU and mainboard chips.

B: Glass Display Control™ (GDC) front glass touch buttons:

As this uses Projected Capacitive technology (instead of conventional hard physical buttons and knobs), the touch controller can react and is sensitive to raindrops (for outdoor installations). To ensure that raindrops do not stay on the unit's flat glass surface, please do not mount the unit in a vertical angle lower than ± 30 degrees, i.e. flat mounting of the unit. This is to prevent accidental touches that are similar to a human finger (cover area for a x period of seconds) as well as make sure the raindrops are "moving" and runs down off the glass surface.

For Maritime Multi Display (MMD) units (not available for Panel Computers (MMC) units), the angle could potentially be lower as the On Screen Display (OSD) menu offers a "OSD Key outdoor" function with 5 seconds delay before activation on front glass functions. Please review the "OSD Menu Functions" to learn more. In certain situations this might help, but is only suggested as a trouble-shooting tip during installation or during short-term observer use if found suitable. It should not be considered as a definitive trusted solution.

C: Projected Capacitive Technology (PCTouch) MULTITOUCH and in general Touch Screen glass:

For all units with a factory mounted touch screen and for outdoor use especially, please review point B above regarding standing raindrops. The only solution to this situation is not to mount the unit in a vertical angle lower than ± 30 degrees, i.e. flat mounting of the unit to ensure touch screen is not activated and accidentally automatically chooses functions in your running chart, radar or other software installed.

D: General rule for console mounted units:

To ensure proper cooling airflow, long-life and stable operation for all units, please make sure that the console casing has either fans or decent ventilation holes to prevent overheating inside the console due to the combined temperature of both Display or Panel Computer units together with other electronic instruments. A general rule is to make sure the console casing is capable of expelling "worst case scenario" in respect of the "Max Power Consumption" of all devices installed. Please review also point 2, 5, 6 and 9 (previous section) for additional information and installation tips.

General Installation Recommendations

General mounting instructions

1. The useful life of the components of all Electronics Units generally decreases with increasing ambient temperature; it is therefore advisable to install such units in air-conditioned rooms. If there are no such facilities these rooms must at least be dry, adequately ventilated and kept at a suitable temperature in order to prevent the formation of condensation inside the display unit.
2. With most Electronic Units, cooling takes place via the surface of the casing. The cooling must not be impaired by partial covering of the unit or by installation of the unit in a confined cabinet.
3. In the area of the wheel house, the distance of each electronics unit from the magnetic standard compass or the magnetic steering compass must not be less than the permitted magnetic protection distance. This distance is measured from the centre of the magnetic system of the compass to the nearest point on the corresponding unit concerned.
4. Units which are to be used on the bridge wing must be installed inside the "wing control console" protected against the weather. In order to avoid misting of the viewing screen, a 25 ... 50 W console-heating (power depending on the volume) is recommended.
5. When selecting the site of a display unit, the maximum cable lengths have to be considered.
6. When a product is being installed, the surface base or bulkhead must be checked to ensure that it is flat in order to avoid twisting of the unit when the fixing screws are tightened, because such twisting would impair mechanical functions. Any unevenness should be compensated for by means of spacing-washers.
7. Products with AC input must be grounded to protective Earth (Safety Ground) when necessary via the bolt (usually on terminal plate) available on the product.
Products with DC input must be grounded to protective Earth (Safety Ground) via the bolt (usually on terminal plate) available on the product.
A shorter and thicker cable gives better grounding. A 6mm² is recommended, but a 4mm² or even 2.5mm² can be used for this purpose.
8. Transportation damage, even if apparently insignificant at first glance, must immediately be examined and be reported to the freight carrier. The moment of setting-to-work of the equipment is too late, not only for reporting the damage but also for the supply of replacements.
9. The classification is only valid for approved mounting brackets provided by Hatteland Technology. The unit should be mounted stand-alone without any devices or loose parts placed at or nearby the unit. Any other type of mounting might require test and re-classification.

General Installation Recommendations

Ergonomics

1. The front surface of the display glass has an anti-reflective (AR) coating which can be scratched and damaged with improper cleaning. It is recommended using only 90+% pure Isopropyl alcohol (Isopropanol) and a soft fabric cloth for this first cleaning. Fold a cloth into a small pad, dampen the cloth with alcohol, and wipe the glass from one edge to the other in one direction with one continuous motion. The product glass will require cleaning as needed. The soft cloth & alcohol wipe is recommended to clean fingerprints and oils off the glass. Water stains (including coffee, tea & coke) should be first cleaned off the glass with a soft fabric cloth wet with water, immediately followed with wiping using an alcohol wetted cloth.
2. Adjust the unit height so that the top of the screen is at or below eye level. Your eyes should look slightly downwards when viewing the middle of the screen.
3. Adjust screen inclination to allow the angle of gaze to remain at the centre of the screen approximately perpendicular to the line of gaze.
4. When products are to be operated both from a sitting position and from a standing position, a screen inclination of about 30° to 40° (from a vertical plane) has turned out to be favourable.
5. The brightness of displays is limited. Sunlight passing directly through the bridge windows - or its reflection - which fall upon the screen workplaces must be reduced by suitable means (negatively inclined window surfaces, venetian blinds, distance from the windows, dark colouring of the deckhead). However, units can be offered with optical enhanced technology and/or High Bright panels to reduce reflections and are viewable in direct sun light, but as a general rule the units at the bridge wing area are recommended to be installed or mounted by suitable alignment or bulkhead / deckhead mounting in such a way that reflections of light from the front pane of the display are not directed into the observer's viewing direction.
6. The use of ordinary commercial filter plates or filter films is not permitted for items of equipment that require approval (by optical effects, "aids" of that kind can suppress small radar targets, for example).
7. For ECDIS applications, the minimum recommended viewing distance are as follows:
(IEC62288, Part 7.5 Screen resolution)

17 inch = 907mm	19 inch = 1010mm	24 inch = 951mm	26 inch = 985mm	27 inch = 1070mm	
-----------------	------------------	-----------------	-----------------	------------------	--

General Installation Recommendations

Cables

Use only high quality shielded signal cables.

Cable Entries & Connectors (Marked area)

Illustration below for smallest/largest sizes only.

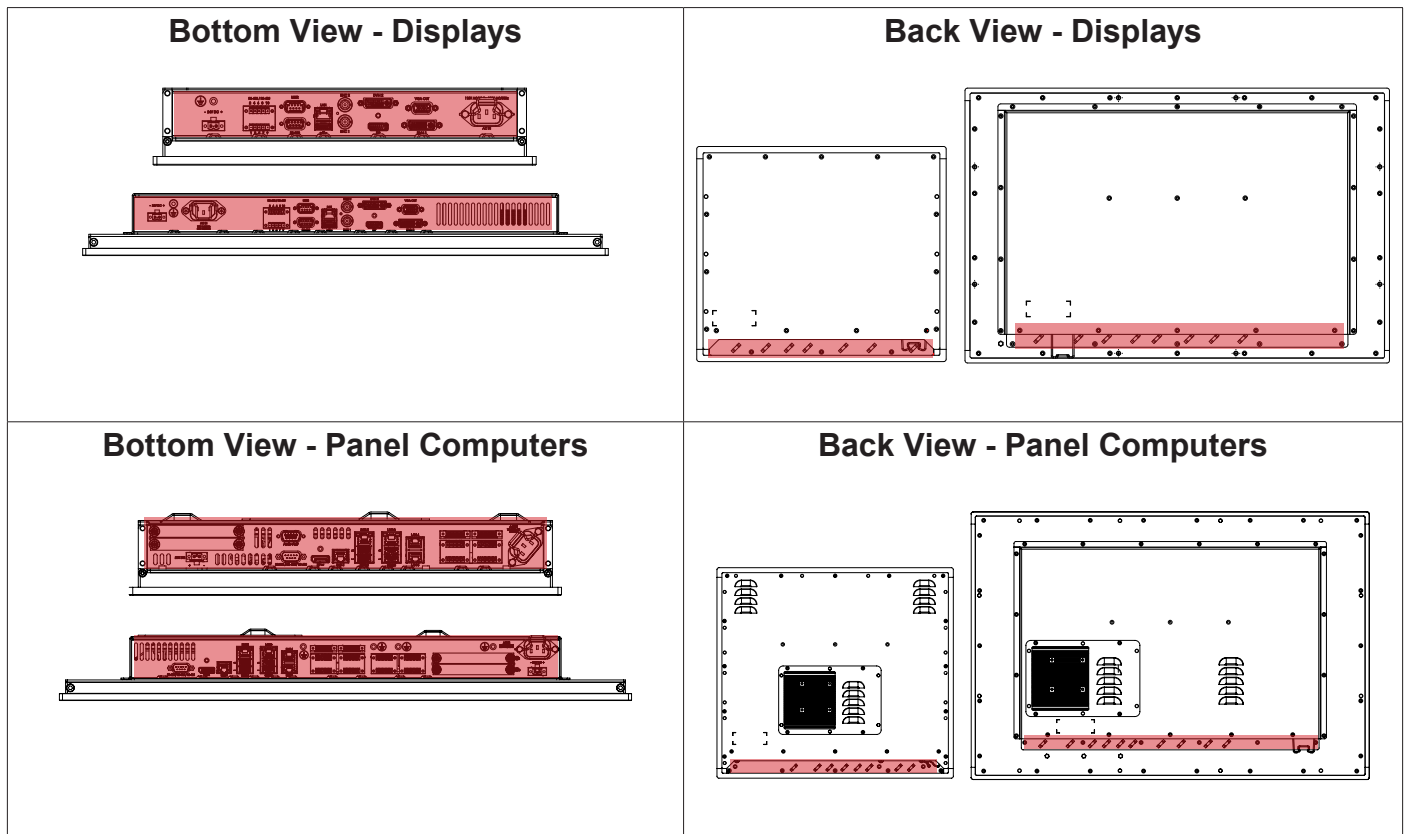

Maximum Cable Length

Any cable should generally be kept as short as possible to provide a high quality input/output. The maximum signal cable length will depend not only on the signal resolution and frequency, but also on the quality of the signal output from the computer/radar.

General Installation Recommendations

Housing / Terminal Block Connector Overview

Housing / Terminal Block connectors are available in different sizes (example 2-pin, 4-pin, 5-pin) which plug into the connector area of the unit. They are mounted by factory default and delivered with the unit. The housing / terminal block connectors have steering rails, which ensures that it can not be mounted wrong. The color of these connectors may vary between black, green and orange depending on manufacturer. You may use approved equivalents of these connectors, but note that the warranty will be void if any damage would occur to either the unit's original PCB terminal socket connector or inside the unit (electronic components, boards etc.). The table below is applicable for any Series X products, such as Display and Panel Computers, including newer type of Stand-Alone Computers.

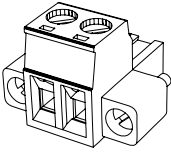
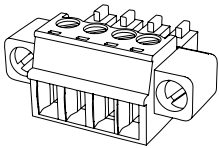
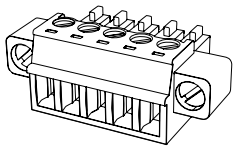
Illustration	Pins	Manufacturer Details	Connector used for module
	2-pin	MSTB 2,5/ 2-STF-5,08 BK Screwdriver: SZS 0,6x3,5, slot-headed. Tightening torque min. 0.5 Nm. Tightening torque max 0.6 Nm.	• DC Power IN (24VDC) - Dual Input Identified on Hatteland Technology product datasheet as: "Terminal Block 5.08"
	4-pin	BCZ 3.81/04/180F SN BK BX Screwdriver: 0.4x2.5mm DIN 5264. Tightening torque min.. 0.2 Nm. Tightening torque max. 0.25 Nm.	• CAN Interface (ZIA0001310-B / ZIA0001310-SLCAN) Identified on Hatteland Technology product datasheet as: "Terminal Block 3.81"
	5-pin	MC 1,5/ 5-STF-3,81 Screwdriver: SZS 0,4X2,5mm VDE, slot-headed. Tightening torque min. 0.22 Nm. Tightening torque max 0.25 Nm.	• RS-422 / RS-485 NMEA (PCA200828-1 / Q170 IO) • Digital Input/Output (PCA100297-1 / Q170 IO) Identified on Hatteland Technology product datasheet as: "Terminal Block 3.81"

If your installation requires additional cable fasteners support, please visit and purchase directly from manufacturer: Illustrations below are approximate, actual Housing and Hood may deviate slightly, but function remains the same.

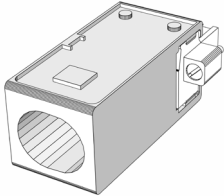
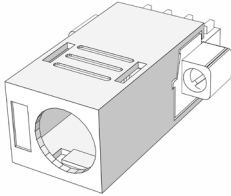
Cable Housing - Illustration	Cover Hood - Illustration
 KGG-MSTB 2,5/ 2 (2-pin) KGG-MC 1,5/ 5 (5-pin)	 BCZ 3.81 AH04 BK BX (4-pin) BCZ 3.81 AH05 BK BX (5-pin)
<p>For 2-pin and 5-pin: https://www.phoenixcontact.com/online/portal/us?uri=pxc-oc-itemdetail:pid=1803934&library=usen&pck=P-11-02-01&tab=1 https://www.phoenixcontact.com/online/portal/us?uri=pxc-oc-itemdetail:pid=1834372&library=usen&pck=P-11-02-01&tab=1</p> <p>For 4-pin and 5-pin http://catalog.weidmueller.com/procat/Product.jsp?jsessionid=B040D5EB6832629E567C884809FDF6C1?productId=(%5b1005290000%5d) http://catalog.weidmueller.com/procat/Product.jsp?jsessionid=D399022A1B3211C0146BCBE716D93211?productId=(%5b1005300000%5d)</p>	

General Installation Recommendations

Configuring Housing / Terminal Block connectors

Below is a brief illustration that might be useful during configuration and installation of such connectors. You will need suitable pre-configured cable(s) and tools to configure the connector(s) and cable(s) that are present in your installation environment. Below is a sample procedure for a 2-pin DC power connector. The procedure is the same for other connectors of this type as listed in table above. Unit used as illustration below is for reference only.

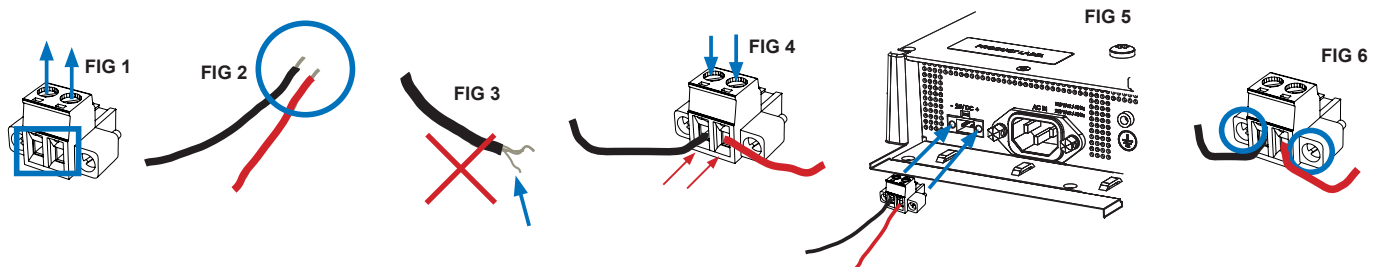

Requires assembly. It is expected that the technician has experience in electronics and assembling cables and connectors.

Warning: Do not connect or disconnect cables/connectors to the unit's connector while the unit is powered on. Failure to do so may result in damaged electronics.

FIG 1: Unscrew (from top) or make sure that the screw terminal is fully open, so you can secure the inserted cables correctly to the loose housing connector (it may already be plugged into the unit as per factory installation).

FIG 2: Strip carefully the insulation from the cable to expose the wire(s) inside.

FIG 3: Ensure that the wire(s) is without any loose threads to ensure good connection.

FIG 4: Insert cables* (from front) and screw / secure the cables by turning the screw on top of the housing to secure the cables properly. Check that the cables are firmly in place and do not appear loose or fall out when pulling gently.

**Note: Required polarization verification (for instance -/+ for DC power input) should conform with the markings on the connector area of the unit. Ignoring the markings on the unit or its add-on modules might damage the unit and/or external equipment in which end, warranty will be void.*

FIG 5: Plug the housing into the appropriate connector area of the unit (glass should be facing down) and check again that the cables secured conform with the markings on the connector area of the unit. Finalize the installation by fastening the screws located in front on each side of the housing connector (**FIG 6**).

Connector / Function	Recommended Cable Thickness
2-pin DC Power Input (Terminal Block 5.08)	Minimum 20 AWG - Maximum 18 AWG
4-pin CAN (Terminal Block 3.81)	Minimum 22 AWG - Maximum 20 AWG
5-pin NMEA COM (Terminal Block 3.81)	Minimum 22 AWG - Maximum 18 AWG
5-pin DIO (Terminal Block 3.81)	Minimum 22 AWG - Maximum 18 AWG

Installation Procedures

Panel Cutout / Console Mounting Bracket Kit for 15, 17 and 19 inch

You need: Hex tool (6mm), 2 pcs of HD CMB SX2-A1 Kit (included in delivery). Procedure suitable for: Display and Panel Computers. Brackets are EN60945 Tested. 19 inch Maritime Multi Display (MMD) used as example below.



Attention: A suitable pre-cut panel cutout should be made prior to mounting. Do not force the unit into the panel cutout as it might break the outer glass or scratch the chassis on the unit. Make sure that the panel cutout is not too tight for the unit. Please disconnect ALL cables before proceeding. Please re-check the relevant and required panel cutout measurements if unsure.

▼ 1: Mount one of the flat brackets on any side on rear of unit first with 3 x M5x12 Countersunk Hex screws as illustrated and fasten it using Torque Force xxNm

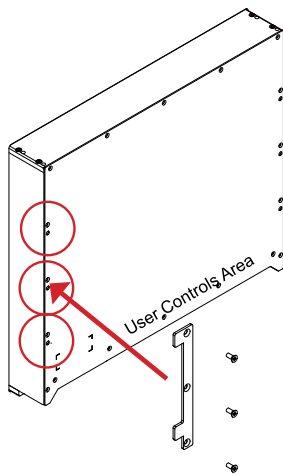

▼ 2: Tilt the unit 45 degree to allow the flat bracket to enter cutout first, then tilt it back 45 degree and slide the entire unit into the cutout evenly and carefully. User Controls and Connector Area should be facing downwards.

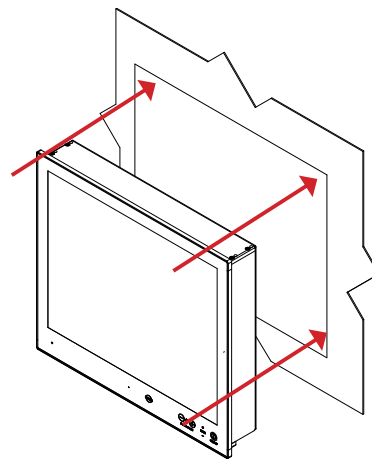

▼ 3: Once unit is in place, mount the other flat bracket on the other side with 3 x M5x12 Countersunk Hex screws as illustrated and fasten it using Torque Force xxNm

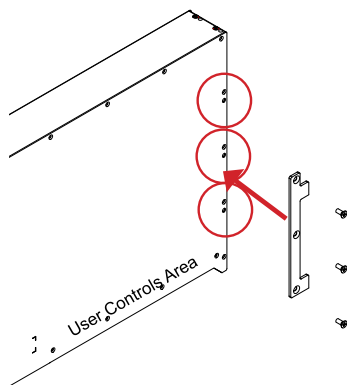

▼ 4: Prepare 4 pcs of Thumb screw and Mounting Socket Nut in separate form as illustrated below.

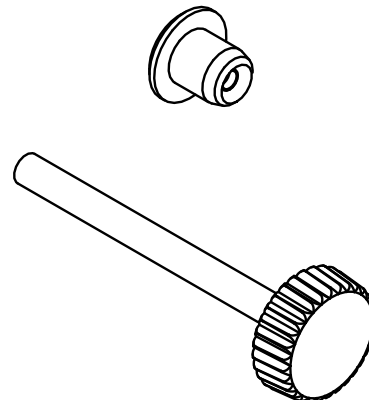

Installation Procedures

▼ 5: Mount the Thumb Screw and Mounting Socket Nut through each of the flat brackets threaded holes as illustrated and fasten the Mounting Nut tight at the end.

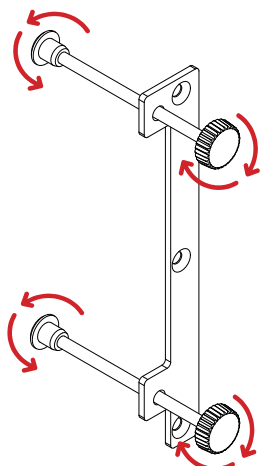

▼ 6: Finally, in a even way fasten each of the 4 Thumb Screws to securely fasten the unit to the rear of the Panel Cutout.

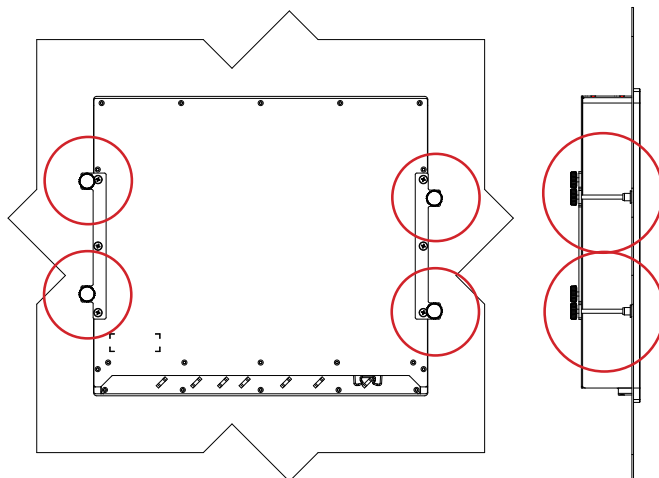

▼ 7: The Console Mounting Kit also allow to edge-to-edge mounting of two units, due to the intersection design of the flat brackets on the rear. Example below illustrates the intersection.

Front View

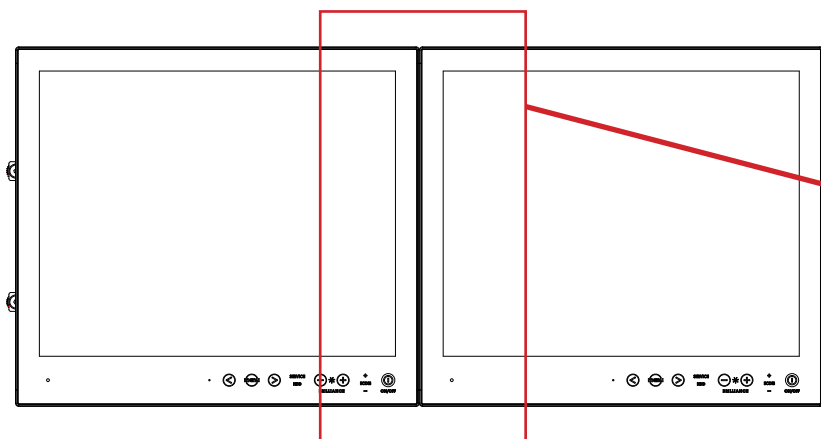

Rear Details

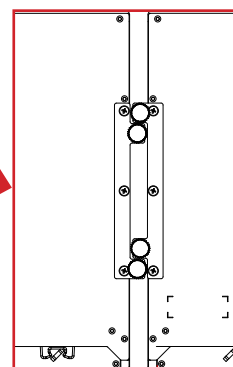

Installation Procedures

Panel Cutout / Console Mounting Bracket Kit for 24 and 27 inch

You need: Torx T25 tool, 1 pcs of HD CMB SX2-E1 kit (included in delivery).

Procedure suitable for: Display and Panel Computers Series X Generation 2 range. Brackets are EN60945 Tested.



Attention: A suitable pre-cut panel cutout should be made prior to mounting. Do not force the unit into the panel cutout as it might break the outer glass or scratch the chassis on the unit. Make sure that the panel cutout is not too tight for the unit. Please disconnect ALL cables before proceeding. Please re-check the relevant and required panel cutout measurements if unsure.

Item	Amount	Art	Description	Notes
	3	P006858-1	Bracket HD 24T21 SH-A	
	1	P020605	HD 2xT2x CMB Bottom	
	6	145 050x016 A4T	M5x16 Pan Head screw ISO 14583 Torx, A4	For P006858-1
	6	144 064x120x22	M6 C-washers DIN6319 Steel	For P006858-1
	2	145 050x016 CA4	DIN 965 M5x16 Countersunk head screws with TX25, A4 STAINLESS STEEL	For P020605

▼ 1: Slide the unit into the cutout carefully. User Controls and Connector Area should be facing downwards.

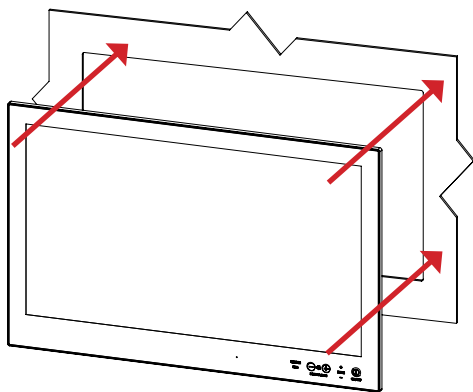

▼ 2: Make sure you are aware that brackets should be mounted on TOP, LEFT, RIGHT and BOTTOM sides. Note that the [B] bracket is different than the [A] brackets and mounted near the connectors. See closeup of details.

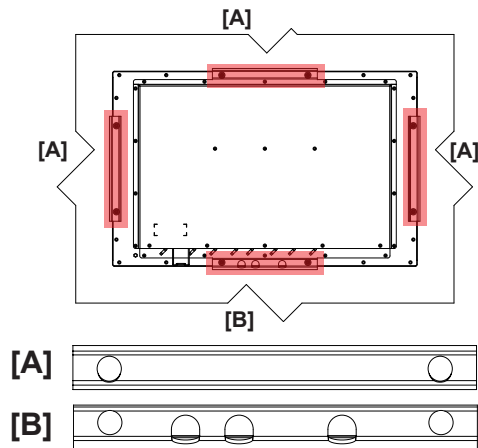

▼ 3: Secure each bracket with the provided screws as illustrated below. Make sure you do it equally and even for all 4 sides. Use Torque Force 3.75Nm. Note the orientation of brackets before you begin.

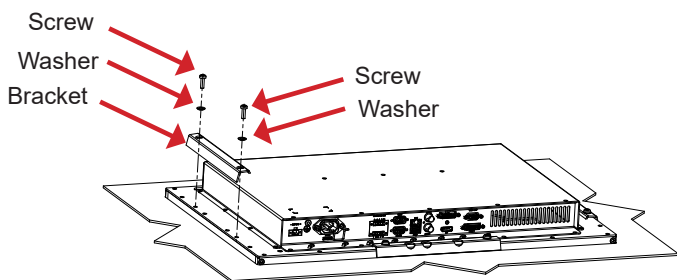

▼ 4: Review closeup of the mounting of brackets with screws. Seen from bottom side.

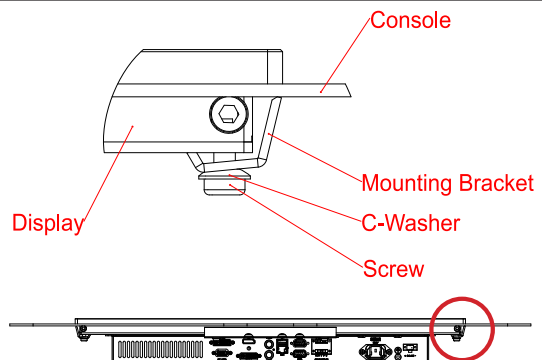

Installation Procedures



Panel Cutout / Console Mounting Bracket Kit for 26 inch

You need: Torx T25 tool, 1 pcs of HD CMB SX2-F1 kit (included in delivery).

Procedure suitable for: Display and Panel Computers Series X Generation 2 range. Brackets are EN60945 Tested.

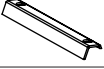

Attention: A suitable pre-cut panel cutout should be made prior to mounting. Do not force the unit into the panel cutout as it might break the outer glass or scratch the chassis on the unit. Make sure that the panel cutout is not too tight for the unit. Please disconnect ALL cables before proceeding. Please re-check the relevant and required panel cutout measurements if unsure.

Item	Amount	Art	Description
	4	P007085-1	Bracket HD 26T2x SH-A
	8	145 050X016 ZT	Panskrue M5x16 Torx, blank
	8	144 064x120x22	M6 C-washers DIN6319 Steel

▼ 1: Slide the unit into the cutout carefully. User Controls and Connector Area should be facing downwards.

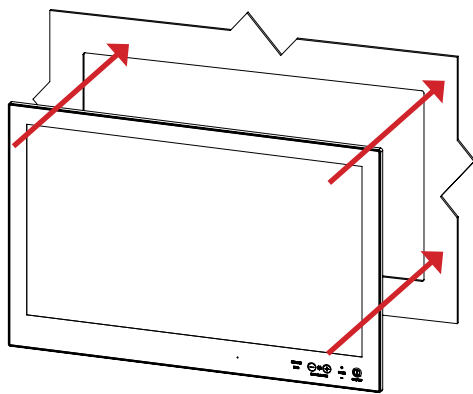

▼ 2: Place and mount the 4 x brackets as illustrated below.

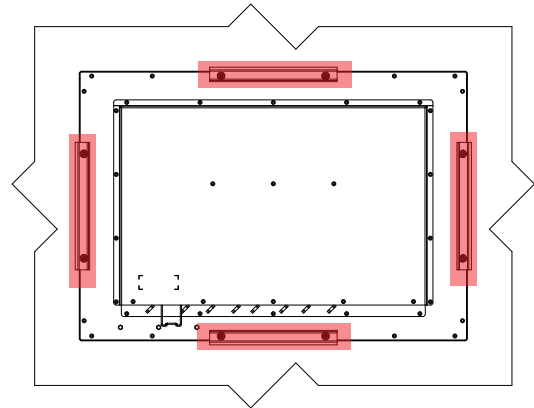

▼ 3: Secure each bracket with the provided M5x16 screws and C-Washers as illustrated below. Make sure you do it equally and even for all 4 sides. Use Torque Force 3.75Nm, 2 screws and 2 washers pr. bracket. Note the orientation of brackets before you begin.

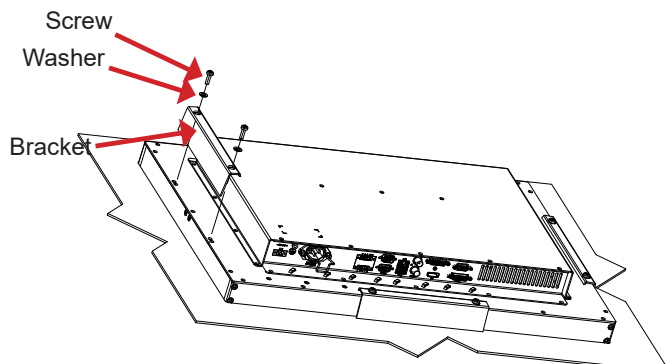

▼ 4: Review closeup of the mounting of brackets with screws and C-Washers in place. Seen from bottom side.

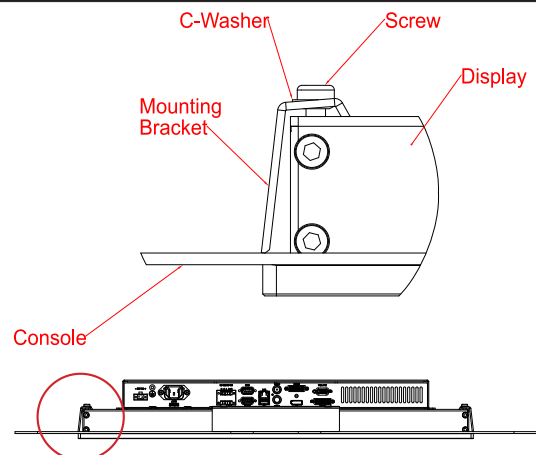

Installation Procedures

Mounting Bracket, Table / Desktop / Ceiling - 15, 17 and 19 inch

Procedure suitable for: Display (MMD) and Panel Computer (MMC) Series X Generation 2 (G2) product ranges.
19 inch Maritime Multi Display (MMD) used as example below.

You need:

- M3 Unbrako® Hex Key tool (not included with delivery).
- Fasteners (6 pcs M6) for mounting complete unit onto table or desktop location (not included with delivery).
- 1 pcs of HD TMB SX2-A1 Mounting Bracket Kit (including pre-mounted 6 x M6x6mm Set Socket Screws).



Attention: Please disconnect ALL cables before proceeding. Please review User Manual or visit www.hattelandtechnology.com for Technical Drawings regarding measurements for both main unit and Mounting Brackets.

▼ 1: Place the unit on a dry, flat, clean, soft surface (i.e. table) with the glass front facing down as illustrated. Connector area should be facing downwards from you.

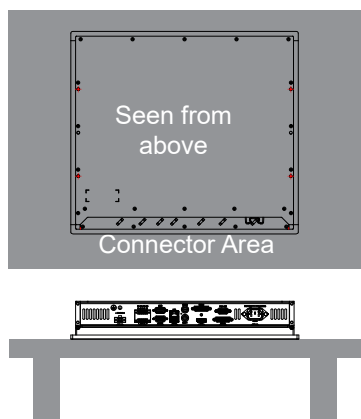

▼ 2: The two bracket pieces comes pre-mounted as shown below. Both sides are identical. Prepare the drilling, location of holes indicated in the footprint below. Drill 6 pcs of 6mm holes in your table/desktop location.

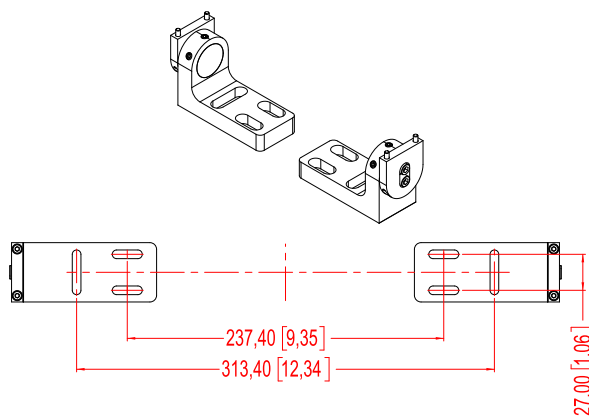

▼ 3: Identify the 3 x Set Socket Screw (M6x6mm) and slightly loosen two of them, now tilt the upper part until you reach an approximate position you need and tighten them slightly.

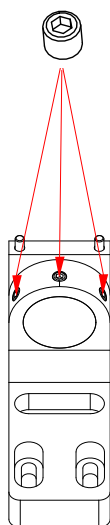

▼ 4: Mount the brackets onto unit as indicated with 2 pcs M4x35 DIN912 screws (included) on both sides. Use Torque Force 2Nm.

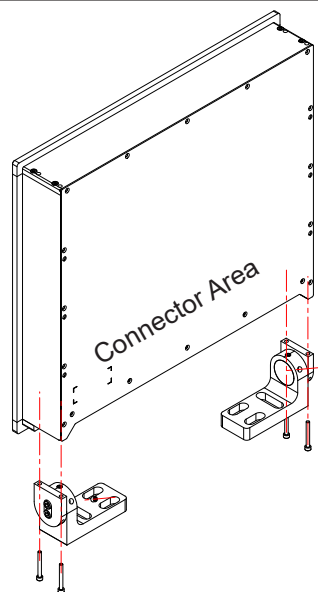

Installation Procedures

▼ 5: Please note the Factory Mounted Torx screws on both bracket sides, THESE ARE NOT TO BE ADJUSTED OR LOOSENED!

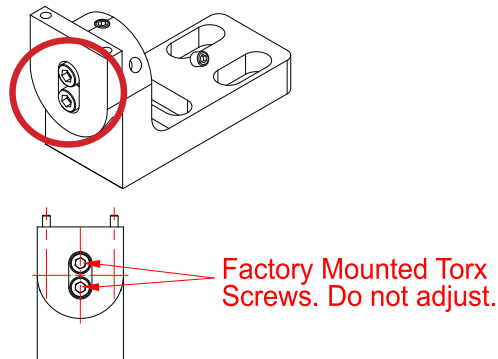

▼ 6: Fasten the complete unit to your table/desktop location, and tilt it into the desired position. Locate the Set Socket Screws on both brackets described in step 3. Secure all 3 Set Top Screws on both sides, use Torque Force 7Nm on all. If you need to re-adjust the tilting later, place your hand on top of the Display/Panel Computer unit to keep it steady, and loosen minimum two of any Set Top Screws on both brackets, adjust unit into new tilting angle, and fasten the Set Top Screws again. Verify that the unit does not tilt by itself and appear fixed in-place.

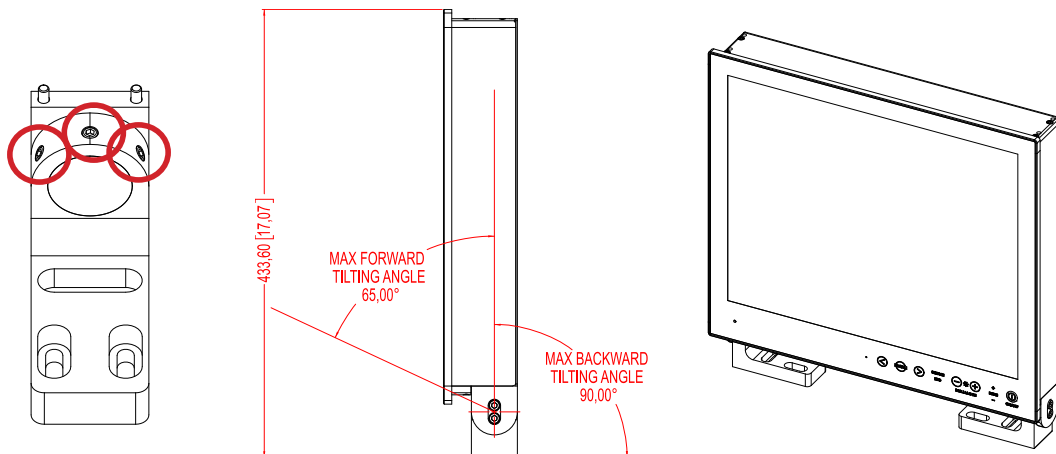

▼ ▼ Alternative Mounting: Depending on installation needs, you may mount the complete unit in ceiling in two different ways.

Upside Down Position: User Controls will be upside down, cables go straight up. You may configure Glass Display Control™ (GDC) LED symbols to show or not, since symbols will be seen upside down. Displayed image needs to be flipped vertically. Review the appropriate SCOM manuals ("Glass Display Control™ (GDC) LED & Button operations" section).

Normal Position: User Controls readable, no image flip needed, cables has to bend up or go straight down.

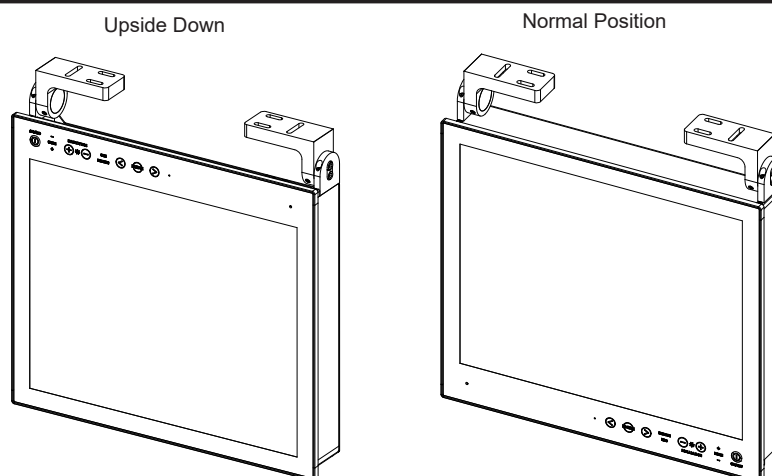

Installation Procedures

Mounting Bracket, Table / Desktop / Ceiling - 24, 26 and 27 inch

You need: M5 Unbrako® Hex Key tool and 1 pcs of HD TMB SX1-C1 Mounting Bracket Kit. Fasteners (6 pcs M6) for Table / Desktop location not included. Procedure suitable for: Display and Panel Computers. 24 inch unit used as illustration below, but same procedure apply for 26 and 27 inch units as well.



Attention: A suitable pre-drilled location should be prepared and checked prior to mounting. Please disconnect ALL cables before proceeding. Please review User Manual or visit www.hattelandtechnology.com for Technical Drawings regarding measurements for both main unit and Mounting Brackets.

▼ 1: Place the unit on a dry, flat, clean, soft surface (i.e. table) with the glass front facing down as illustrated. Connector area should be facing downwards from you.

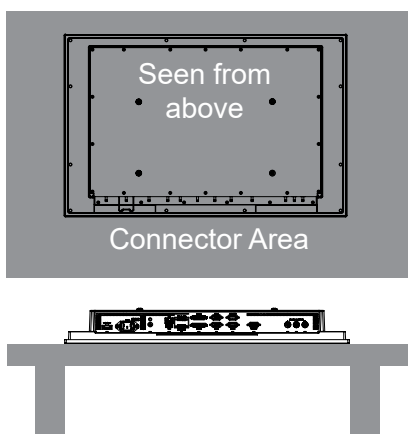

▼ 2: Inspect the mounting holes of brackets. For mounting to a 24 inch unit, please use the **lower holes** as indicated. For mounting to a 26 / 27 inch unit, please use the **upper holes** as indicated.

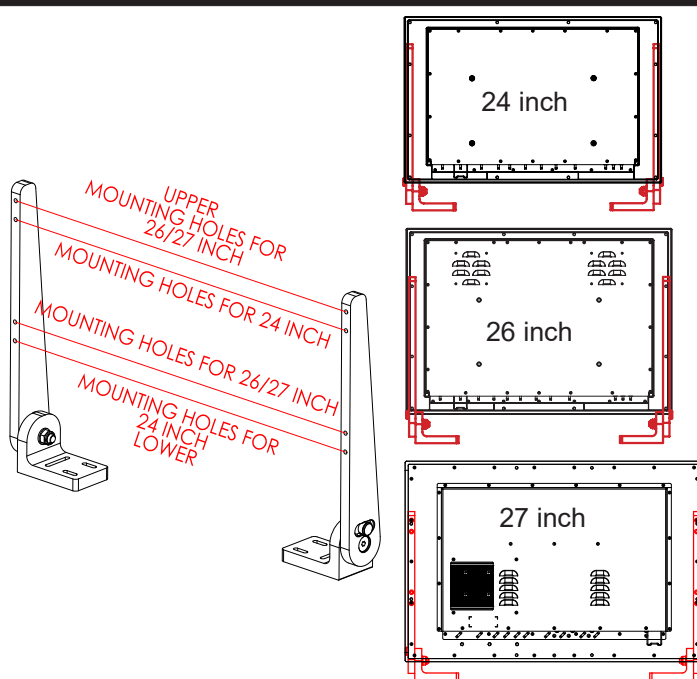

▼ 3: Place one bracket at the time with the mounting holes facing down into the suitable mounting position and fasten with 2 x M5 screws on each bracket. Torque Force 3.5Nm.

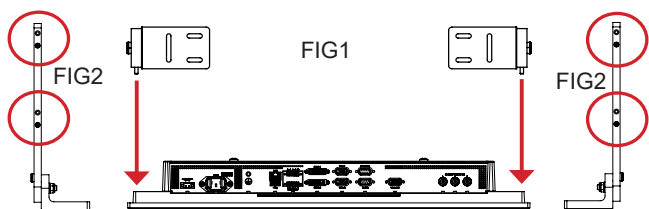

▼ 4: While unit is lying flat on table, check the Tilting Lock Pin position. These can be pulled out by hand, turned 90° (FIG1) and turned back 90° until the Lock Pin automatically clicks into place by a spring (FIG2).

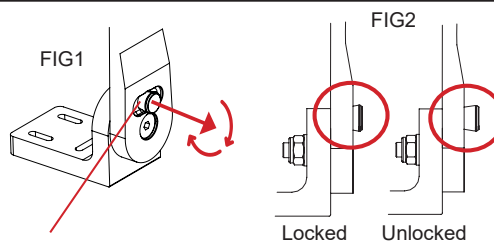

Installation Procedures

▼ 5: You may now mount the unit onto your desired location. It is advised that you unlock the Lock Pin (as shown in step 4), tilt the unit 90° backwards (FIG1) and properly fasten the bracket base into location (FIG2).

NB! Be careful not to break or scratch the edge of the front glass! Then repeat step 4 again until your desired tilting position has been achieved and you have verified that the Lock Pin are in locking position and the unit is firmly attached and does not appear loose (FIG3).

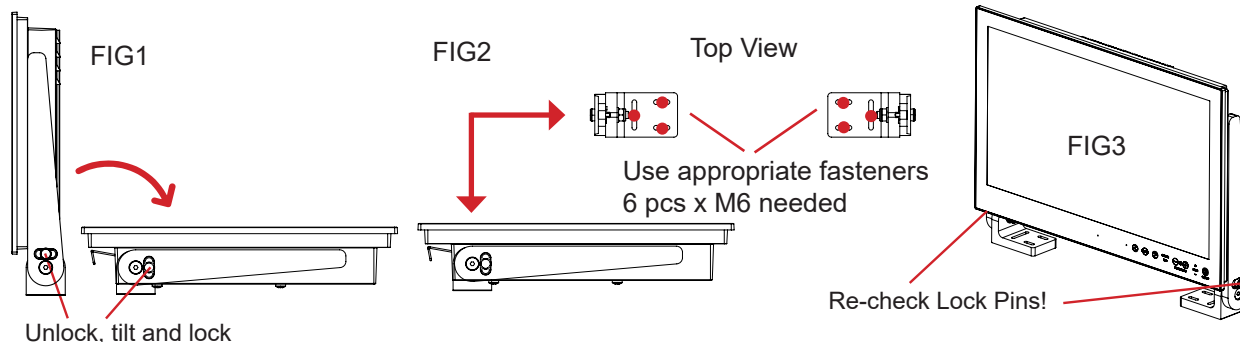

▼ Alternative Mounting: Depending on installation needs, you may mount the complete unit in ceiling in two different ways.

Upside Down Position: User Controls will be upside down, cables go straight up. You may configure Glass Display Control™ (GDC) LED symbols to show or not, since symbols will be seen upside down. Displayed image needs to be flipped vertically. Review the appropriate SCOM manuals ("Glass Display Control™ (GDC) LED & Button operations" section).

Normal Position: User Controls readable, no image flip needed, cables has to bend up or go straight down.

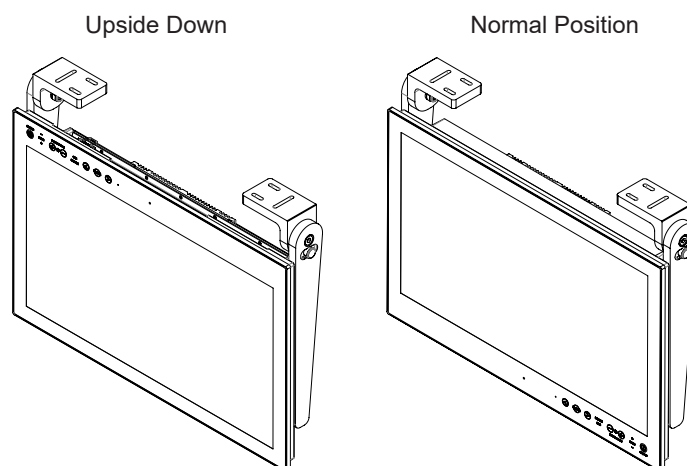

Physical Connections

Connection area of unit (illustration)

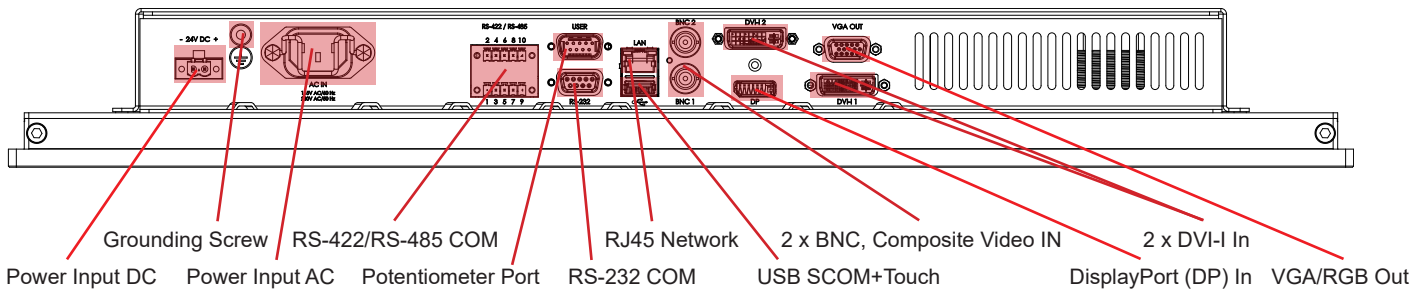

Note: 24 inch unit used as example above, please review specifications for your actual model.

Reduce Cable Tension

To reduce tension on the cables you connect, secure them with a cable tie to the available chassis hinges located near the connectors.

Note: Amount of chassis hinges can vary depending on model.

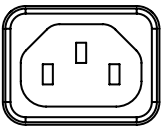
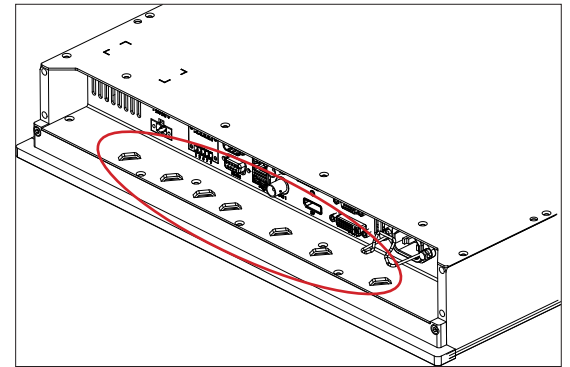

POWER INPUT:

The internal AC power module supports both 115VAC/60Hz and 230VAC/50Hz power input. Please check specifications for your unit.

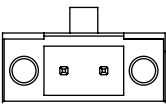

- +

POWER INPUT:

Connect your DC power cable to the 2-pin Terminal Block 5.08 connector. The internal DC power module supports 24VDC. For more information, please review "Housing Connector Overview" earlier in this manual.



GROUNDING SCREW:

Please review "General mounting instructions" in the "Installation" chapter, pt. 7 for more information.

Note for Grounding Screws: Standard Grounding Screw/Bolt provided by Hatteland Technology is "Pan head screws M4x8mm w/spring and plainwasher".

Multi-power note: (For units supporting AC & DC input simultaneously)

The unit has a dual input power supply which will accept both AC and DC input. If both inputs are connected, the unit will be powered by AC. If AC is disconnected it will automatically switch over to DC without affecting the operation of the unit. This makes it possible to use AC power as primary power and a 24V battery as secondary power, eliminating the need for expensive UPS systems.

Physical Connections

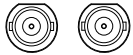

COMPOSITE VIDEO IN 1,2:

Connect a Composite Video signal (PAL/NTSC/SECAM) to any of these 2 x BNC female connectors to allow video feed to be used as Full Screen, Picture-In-Picture (PIP) or Picture-By-Picture (PBP) from i.e. cameras & DVD players in addition to the regular DVI, DP or RGB/VGA (Via adapter) signal input.

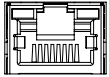

Network/LAN INPUT / OUTPUT (NET A):

Supports 10/100/1000Mbps Ethernet (LAN). Suitable for twisted pair cables CAT.5E. Make sure the network cable connector "clicks" into the RJ-45 connector. This connector will allow remote control via SCOM of the display unit to control common functions like brightness, input source and more.

Hatteland Technology's Serial Remote Control Interface (SCOM) protocol document can be downloaded from: <https://www.hattelandtechnology.com/hubfs/pdfget/inb100018-6.htm>



USB TOUCH SCREEN / SCOM:

Connect a TYPE A USB Cable between this connector and your PC. Port is USB2.0 (<5m). This connector transmit touch screen signal from the display unit (if factory mounted) to connected computer. In addition it also simultaneously supports remote control of the display unit to control common functions like brightness, input source and more via the Serial Remote Control (SCOM) as provided by Hatteland Technology.

Hatteland Technology's Serial Remote Control Interface (SCOM) protocol document can be downloaded from: <https://www.hattelandtechnology.com/hubfs/pdfget/inb100018-6.htm>

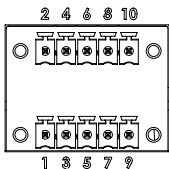

RS-422 / RS-485 COM I/O:

The COM (non-isolated RS-422/485) allows functionality to communicate with serial based equipment including controlling internal buzzer externally. Connect and fasten your cables from your compatible external equipment to the 5-pin Terminal Block 3.81 connector. Please review the "Pinout Assignments" chapter as well as "Housing / Terminal Block Connector Overview" in this manual for more information.

Hatteland Technology's Serial Remote Control Interface (SCOM) protocol document can be downloaded from: <https://www.hattelandtechnology.com/hubfs/pdfget/inb100018-6.htm>

Physical Connections

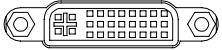

DVI-I IN:

Connect your DVI cable to any of the two DVI-I 29p connector (female). Secure your DVI cable to the hex spacers provided on the unit and make sure you do not bend any of the pins inside the connector. Connect the other end of the cable to the DVI connector on your equipment and secure it.

Note for DVI and VGA signal inputs:

DVI-I #1, DVI-D #1 and VGA #1 is Single Link. DVI-I #2, DVI-D #2 and VGA #2 is Dual Link.

Important note for DVI signal detection:

Please note that for the operating system to detect DVI signals correctly, the DVI cable MUST be connected physically to the unit during boot up otherwise you may experience a black image. Furthermore certain graphics drivers may need to refresh their device list (often done manually by user - detect devices), while in some cases the Plug-n-Play will automatically detect the DVI signal correctly. Please consult your local technician if you have this behavior of detection problems when using DVI. In all cases the problem can be solved in the operating system, and this is not a malfunction in the graphic controller for display units.



DisplayPort (DP) IN:

Connect your DP (male) cable to the DisplayPort (v1.2) 20P connector (female) of the unit. The DP has its own locking mechanism that locks the plug inserted. Make sure the plug “clicks” into place to verify a proper and secure connection.

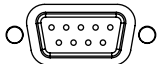

RS-232 COM I/O:

This D-SUB 9P connector (female) provides additional functionality for the unit. The Serial Remote Control features a RS-232 (non-isolated) interface for controlling internal parameters like brightness. You can access most of the parameters available in the OSD menu and with special commands control the unit externally. This COM can also be used to upgrade the firmware for the graphic controller inside the unit which is available on request and through service channels (for qualified personell only). Fasten your external cable to the D-SUB 9P connector (female) using the provided screws on the cable housing.

Please review “Management Settings/Communication” in the “OSD Menu Functions” chapter for more information.

Hatteland Technology’s Serial Remote Control Interface (SCOM) protocol document can be downloaded from:

<https://www.hattelandtechnology.com/hubfs/pdfget/inb100018-6.htm>

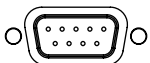

POTENTIOMETER INPUT / OUTPUT:

Allows for controlling Brightness of the displayed image on screen by connecting an external remote control to the D-SUB 9P connector (male) which has Potentiometer IN, +5VDC OUT and BRT +/- IN functionality built in. Review the “Pin Assignments” chapter in this manual for more information on how to activate this functionality.

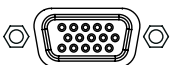

VGA OUT:

VGA OUT enables a direct clone of the incoming VGA signal if using a DVI-I to VGA adapter. Connect the cable to the D-SUB 15P connector (female) and secure it to the hex spacers provided on the unit. Connect the other end to your equipment and secure it. Note that only DVI-I port #1 supports cloning.

This page left intentionally blank



Operation

USER CONTROLS OVERVIEW

The units are designed using Glass Display Control™ (GDC) touch technology to allow interactivity adjusting brilliance (brightness) and control power on / off with the use of illuminated symbols. Note that these symbols are only visible (backlight illuminated) when suitable power is connected, except for the power symbol which has a white silk print to indicate its position on the front glass. Further, not all symbols are available depending on factory options and product sizes (where applicable). There are no physical moving knobs, potmeters, wheels or push buttons available as everything is touch surface controlled by Projected Capacitive technology that allows a human finger (including several types of gloves) to control the unit.

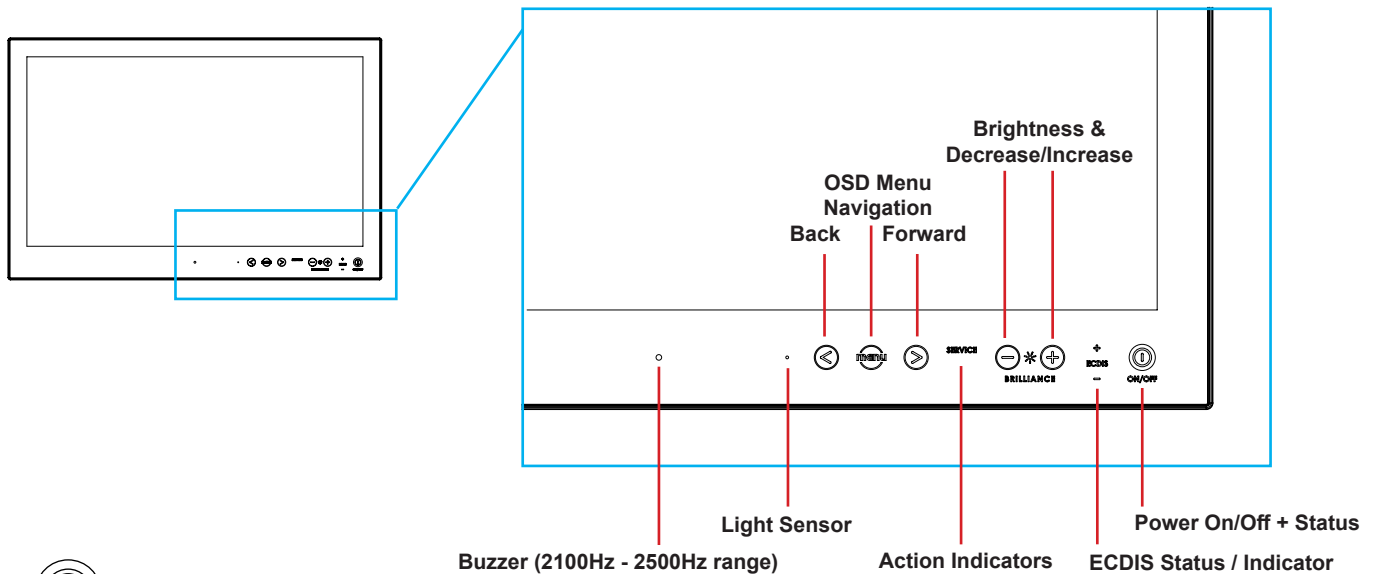

ON/OFF

Power ON/OFF:

This symbol and all text will illuminate in red when suitable power is connected and the unit is turned off. When the unit is on and operating, this symbol will illuminate constantly either in yellow color (signal not recognized/not present and no image on screen) or green color (signal detected and image on screen).

Power ON:

To turn the unit on, verify that the symbol is illuminated in red (indicates suitable power is connected) and touch the power symbol and hold until the the symbol changes to green light/yellow light or a image appears on the screen.

Power OFF:

To turn the unit off, touch the power symbol and hold until it either illuminates/changes from green/yellow to red or the image on screen disappears.



OSD Menu, Navigation:

If the OSD (On Screen Display) menu was activated (and is clearly visible on screen), both the "<" and ">" are used to navigate, set options and change values within the OSD menu.

To access the main OSD menu, touch anywhere on the "MENU" circle symbol and the OSD menu will clearly be seen as an overlay over the existing displayed image. The complete definition of all the menus and functions are available in the "OSD MENU FUNCTIONS" chapter in this manual.

User Controls

SERVICE
SERVICE **Action Indicators:**
= Reserved for future use, no built-in function defined.



BRILLIANCE **Brightness Adjust:**
Brilliance / Brightness adjustment of the displayed image is adjusted by touching the (-) or (+) illuminated symbols. The entire area of text and symbols are visible as long as the unit is powered. Note that only the (-) and (+) are touch sensitive while the "*" and "BRILLIANCE" symbols are not.

+ ECDIS - **ECDIS Status / Indicator:** (optional factory standard)
For units that have been factory ECDIS calibrated the text "ECDIS" will illuminate in green constantly as long as the unit is powered. The "+" and "-" symbols will illuminate in orange when the Brightness/Brilliance is adjusted either above or below ECDIS factory calibration point.

To be able to stay within ECDIS calibrated range, please assure that both the "+" and "-" are not illuminated in orange color and that "ECDIS" text remains illuminated in green during operation. Note that by touching these symbols no action will be performed or has been assigned.

Note: ECDIS functionality is mostly only suitable for model sizes above 15 inch units.



○ **Light Sensor:**

Used to sense level of ambient light in the surrounding environment. The sensor data can be read by suitable software through the Hatteland Technology SCOM functionality of the unit and thus can be used to control brightness remotely. Note: This sensor is barely visible to the eye and lies under the glass. It has no illumination behind to indicate its position. Touching or covering this area will naturally make the sensor data inaccurate and should be avoided!

○ **Buzzer:**

Only functional for units ordered with Buzzer functionality. The location of the buzzer hole (physical hole in glass) is barely visible to the eye. Touching this area will naturally mute buzzer sound or in some cases make it lower or change audible frequency. In no circumstances should this area be blocked by either stickers or objects! Please review the "Pinout Assignments" chapter in this manual for controlling the Buzzer functionality.

Note:
In the following "On Screen Display (OSD)" menu chapter, these buttons are referenced as:

	"MENU"
	"(-) Brilliance (+)"
	"(<) Navigation (>)"

Note: GDC Symbols on front glass will by factory default fade away if signal input was lost, cable detached etc. Review OSD Menu function, "Keep OCM Mode" and its settings of "On" and "Off" meaning.

On Screen Display (OSD) Menu Introduction

The OSD menu consists of main menus and submenus which are very easy to navigate through. All functions are explained in-depth later in this user manual. Prior to using the OSD menu, you should be sure to familiarize yourself with how to physically access the menu, how to navigate up/down/left/right, how to modify values, exiting menus and more.



Please note: Factory default illustrations only! Available functions, icons and text may deviate slightly from actual OSD menu on your product due to different OSD software configurations and customized solutions.

OSD Key Code (password) overview

During use/accessing the OSD menu, based on factory default or customized configuration, there might be a pop-up requester asking for a Key Code (password) to gain further access to requested menu. These are 3 digits long.

Keycode	Description
321	Applies for "ECDIS Compliance" products. Code must be entered to get access to OSD MENU. Configured in OSD parameter: "OSD Settings > OSD Lock Mode > Menu Protect"
362	If OSD are in Basic Mode, entering code gets access to Advanced Mode. Configured in OSD parameter: "OSD Settings > OSD Mode > Advanced"
---	Service Mode - Only applicable for authorized service personnel. Configured in OSD parameter: "OSD Settings > OSD Mode > Service"

OSD Menu Overview

OSD Keycode / OSD Lock Mode

During use, a small requester may pop-up on screen asking you for a “Key Code”. This is a safety feature (due to ECDIS Compliance) that might be predefined in your setup. To quickly understand how to enter a code, navigate and finally access the underlying main menu, simply follow the illustration below. The “Key Code” is factory default set to “321”. If the “Key Code” requester do not appear on screen, you can skip reading this section for now and proceed to the next page.

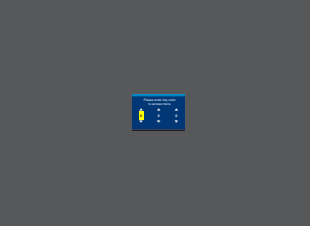
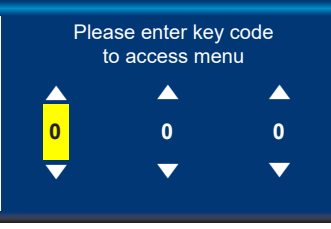
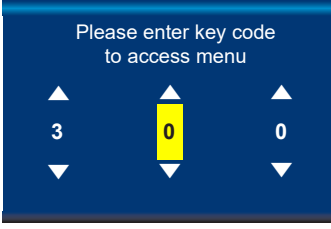
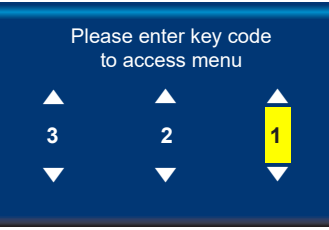
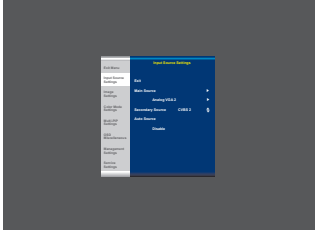
 <p>Active Display Area + Requester</p>	 <p>Close-up of Requester</p>	 <p>Close-up of Requester</p>
<p>1: Typical position of requester on screen. Yellow box indicate number position, default location is always on first number.</p>	<p>2: Enter first number (from 0 to 9). Use “Navigation/Hot Keys” touch buttons to increase/decrease. Number change in real time.</p>	<p>3: Now touch menu button to store first number and proceed to second number. Yellow bar will move its position too.</p>
 <p>Close-up of Requester</p>	 <p>Active Display Area + OSD Menu</p>	
<p>4: Repeat step 2 and 3, until “Key Code” reads “3 2 1” and finally touch menu button to continue.</p>	<p>6: The OSD menu appear by default in the middle of Active Display Area</p>	

After the code is successfully entered you will gain access to the OSD Menu and a multitude of functions will be available for adjusting or reviewing. Please proceed to the next page, where you will learn the differences between the different menu modes and a complete map of all the underlying functions available within.

OSD Menu Overview

OSD “Basic”, “Advanced” & “Service” Menu modes



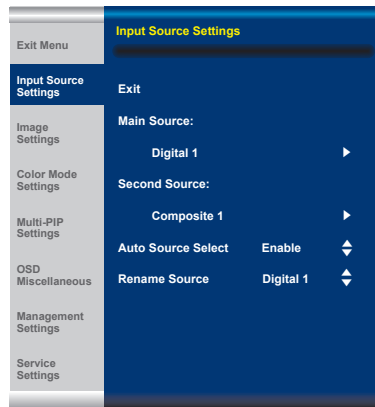

Three OSD Modes are available. The “Basic” Menu mode offers easy and clear access to most commonly used functions. The “Advanced” Menu mode offers a more advanced menu with technical information and is suited for more technical minded users and the “Service” Mode reveals more options in “Service settings” for service purposes. “Advanced” and “Service” modes are password (KeyCode) protected. Password for Advanced Mode is “362”, Password for Service Mode is intentionally only available from Service Partners and our HelpDesk which should only be used by experienced personnell. Please contact your Service Partner or our HelpDesk to retrieve the password.



OSD Menu showing for example “Input Source Settings” chosen in the menu. The left menu bar is visible at all times, while the right section will change based on contents of that submenu. The design and size of OSD menu area does not change, even in any of the “Basic”, “Advanced” and “Service” mode settings.

OSD Visual Feedback (examples)

Throughout all OSD menus there are certain symbols you need to familiarize yourself with. These are to visually indicate that a value can be increased/decreased, accessed, display a Slide Bar Meter or just for information purposes only. All functions with arrows have text based, human readable lists with start and end choices. A Slider Bar with number beside it will indicate the value has a minimum, current and max limit. All changes in values and lists happen in real time as you touch the menu button and/or touch navigation buttons.

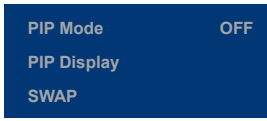
	
Arrow pointing right means that there is a submenu available for this function for further adjustments and functions.	Arrow pointing up/down means that the current choice can be changed in-place from a list that has a start and end.
	
Slider Bar meter indicates the “filling” up based on a minimum and maximum value. The current value is written to the right.	Whenever a function is selected, the item will be visually indicated with a yellow bar behind it. The other choices available will be in white text with no yellow bar behind.
	
Functions displayed in Green Color indicates either the current stored value of the function and sometimes to draw user’s attention towards information about a selected function or its current state.	Functions displayed in gray text means that set of functions may depend on a different option to be turned on or configured first. In this example, “PIP” functions are all unaccessible, since “PIP Mode” is “OFF”.

Note: The examples above are the most common ones displayed. Your menu may have slight different style and colors, depending on firmware, variations and customized solutions, but the logic of operation is the same.

OSD Menu Overview

OSD Menu Structure

In this table all functions within menus and their submenus are shown. Functions that begins with an asterix (*) and in **bold/red font color** style indicates this function/menu is only available during “Advanced” menu mode or during Video CVBS fullscreen. Functions that begins with an asterix (*) and in **bold/blue color** indicates this function is only available while in “Service” menu mode. Functions with a “>” in the end, indicates a submenu or list of options will be displayed. Depth of the sub-menus (levels) are identified from 1 to 5.

Input Source Settings

Level 1 (Main Menu)	Level 2	Level 3	Level 4	Level 5
Exit				
Input Source Settings >	< Exit			
	Main Source >	< Exit		
		Digital 1, Digital 2, Analog RGB1, Analog RGB2, Composite 1, Composite 2, Composite 3, DisplayPort1	(Text Displayed)	
	Second Source >	< Exit		
		Digital 1, Digital 2, Analog RGB1, Analog RGB2, Composite 1, Composite 2, Composite 3, DisplayPort1	(Text Displayed)	
	Auto Source Select >	< Exit		
	DVI-I1 Mode		DVI Mode/VGA Mode/Auto Mode	
	DVI-I2 Mode		DVI Mode/VGA Mode/Auto Mode	
	Auto Source Selection		Enable/Disable	
Rename Source >	<On Screen Keyboard Input>			

Image Settings

Level 1 (Main Menu)	Level 2	Level 3	Level 4	Level 5	
Image Settings >	< Exit				
	Auto Position >	(Automatic Action)			
	Auto Color Balance >	No/Yes			
	*Brightness >	(Slider Bar 0~255)			
	*Contrast >	(Slider Bar 0~255)			
	*Saturation >	(Slider Bar 0~255)			
	*Hue >	(Slider Bar 0~255)			
	Sharpness >	(Slider Bar 0~24)			
	Display >	< Exit			
		H. Position >		(Slider Bar 0~100)	
		V. Position >		(Slider Bar 0~100)	
		Clock >		(Slider Bar 0~100)	
		Phase >		(Slider Bar 0~100)	
		Picture Direction >		Select 0/180	
	*Video Setup >	< Exit			
		Main MADI Mode >		Normal, Adaptive, Off	
		Noise Reduction >	< Exit		
Dynamic NR Mode >					High, Medium, Low, Adaptive, Off
MPEG NR Mode >					On, Off
Sharpness Noise Coring >				High, Medium, Low, Adaptive, Off	
Film Mode >		2:2, 3:2, 3:2-2:2, Off			
DCDi >		On, Off			

OSD Menu Overview

Color Mode Settings

Level 1 (Main Menu)	Level 2	Level 3	Level 4	Level 5
Color Mode Settings >	< Exit			
	Color Temperature >	9300K, 8000K, 6500K > User >	(Automatic Action)	
			< Exit	
			Red >	(Slider Bar 0~255)
			Green >	(Slider Bar 0~255)
			Blue >	(Slider Bar 0~255)
	*Gamma >	No Calibration, Calibration VGA, Calibration DVI, Calibration DisplayPort		

Multi-PIP Settings

Level 1 (Main Menu)	Level 2	Level 3	Level 4	Level 5	
Multi-PIP Settings >	< Exit				
	PIP Mode >	PIP Off, PIP Child, PIP Split, PIP Wide.			
	PIP Display >	< Exit			
		PIP Child Size >		< Exit	
				PIP Size >	(Slider Bar 1~9)
				PIP H-Size >	(Slider Bar 0~20)
			PIP V-Size >	(Slider Bar 0~20)	
		PIP Position >		< Exit	
			PIP H-Position >	(Slider Bar 0~100)	
			PIP V-Position >	(Slider Bar 0~100)	
	Swap Source >	(Automatic Action)			
	PIP Picture >	< Exit			
		Brightness >		(Slider Bar 0~255)	
Contrast >			(Slider Bar 0~255)		
Saturation >			(Slider Bar 0~255)		
Hue >			(Slider Bar 0~255)		
	Sharpness >		(Slider Bar 0~24)		

OSD Menu Overview

OSD Miscellaneous

Level 1 (Main Menu)	Level 2	Level 3	Level 4	Level 5	
OSD Miscellaneous >	< Exit				
	OSD Position >	< Exit			
			OSD H. Position >	(Slider Bar 0~255)	
			OSD V. Position >	(Slider Bar 0~255)	
	Language >	< Exit			
			Norsk >	(Select for Norwegian)	
			English >	(Select for English)	
			Français >	(Select for French)	
			Deutsch >	(Select for German)	
			Italiano >	(Select for Italian)	
			日本語 >	(Select for Japanese)	
			簡體中文 >	(Select for Simplified Chinese)	
	Presets >	< Exit			
			Recall >	(Automatic Action) Performs Factory Defaults!	
			Save >	< Exit	
				User 1 to 5 >	(Automatic Action)
			Load >	< Exit	
				User 1 to 5 >	(Automatic Action)
	OSD Timeout (Sec) >		(Slider Bar 0~30)		
	OSD Transparent >		(Slider Bar 0~255)		
	OSD Mode >	< Exit			
			Basic >	(Select)	
			Advanced >	(Select) and Enter Key Code "362"	
			Service >	(Select)	
	*OSD Lock Mode >		Normal Mode >	(Select)	
			Menu Protect >	(Select) and Enter Key Code "321"	
			Full Protect >	(Select) and Enter Key Code "321"	
*Hot Key Assignment >		Key 1 >	OSD Language, Test Pattern, Swap Source, Graphic Scaling, PIP Mode, Second Source, Main Source, PIP Child Size, Black Level, No Function		
		Key 2 >	OSD Language, Test Pattern, Swap Source, Graphic Scaling, PIP Mode, Second Source, Main Source, PIP Child Size, Black Level, No Function		
*OSD Key Outdoor >	< Exit				
		On / Off			
Spectrum >		(Slider Bar 0~512)			
* Keep OCM Mode >		On / Off			

OSD Menu Overview

Management Settings

Level 1 (Main Menu)	Level 2	Level 3	Level 4	Level 5	
Management Settings >	< Exit				
	* Graphic Scaling >	< Exit			
		Graphic Scaling >	Full Screen, Fill to Aspect Ratio, One To One		
		Zoom >	(Slider Bar 0~100)		
		Horizont Stretch >	(Slider Bar 0~100)		
		Vertical Stretch >	(Slider Bar 0~100)		
		Auto Adjustment >	On, Off		
		* Unknown Timing Search >	< Exit		
			Auto Mode >	< Exit	
				Display Size >	4:3, 5:4, 1:1, 16:9, 16:10
				Execute >	(Automatic Action)
			Blind Mode >	< Exit	
				H. Resolution >	(Slider Bar 0~2000)
				V. Resolution >	(Slider Bar 0~2000)
				Total H. Line >	(Slider Bar 0~2000)
				H. Blank Pixels >	(Slider Bar 0~500)
				V. Blank Pixels >	(Slider Bar 0~500)
				Execute >	(Automatic Action)
			Save Timing >	Save Timing 1 to 8 >	(Automatic Action)
			Clear Timing >	Clear Timing 1 to 8 >	(Automatic Action)
		* GDC Sensitivity >	(Slider Bar 0~255)		
		* Filter >	Enable, Disable		
		* Communication >	< Exit		
			RS232 >	(Select)	
			2-wire RS-485 >	(Select)	
			4-wire RS485/422 >	(Select)	
			Address RS >	(Slider Bar 0~15)	
			IP Address >	Auto IP >	(Select)
				Fixed IP >	(Number Input; xxx.xxx.xxx.xxx)
			USB	(Select)	
			Enable RS232	Enable, Disable	
			FW Download >		
		* Power Plan >	< Exit		
			VGA Out / USB in OFF Mode >	Enable, Disable	
			LAN in OFF / Sleep Mode >	Enable, Disable	
		* Touch Power Enabled >	< Exit		
			Always Active >	(Select)	
			Any signal is On >	(Select)	
			Select signal is On >	< Exit	
				Digital 1 >	(Select)
			Digital 2 >	(Select)	
			Analog RGB 1 >	(Select)	
			Analog RGB 2 >	(Select)	
			Composite 1 >	(Select)	
			Composite 2 >	(Select)	
			Composite 3 >	(Select)	
			DisplayPort 1 >	(Select)	
	* External Power Button >	Enable, Disable			
	* DDC/CI Setting >	Digital 1, Digital 2, Analog RGB1, Analog RGB2, DisplayPort 1, None			

OSD Menu Overview

Service Settings

Level 1 (Main Menu)	Level 2	Level 3	Level 4	Level 5
Service Settings >	< Exit			
	Video Scaler Firmware Ver >	(Text Displayed)		
	uC Firmware >	(Text Displayed)		
	Elapsed Time >	(Text Displayed)		
	Current Temp >	(Text Displayed)		
	*Fault Status >	(Text Displayed)		
		*< Exit		
		NVRAM >	(Text Displayed)	
		Ethernet >	(Text Displayed)	
		GDC >	(Text Displayed)	
		TMP Sensor >	(Text Displayed)	
		Video Scaler >	(Text Displayed)	
		Test Pattern >	(Automatic Action)	
		*Burn In >	Enable, Disable	
	*Smart ISP >	(Select)		
	*Watchdog Test >	(Select)		

OSD Menu Functions

On Screen Display (OSD) Menu Functions

The following section covers all possible settings that the user can (in a certain mode) encounter or needs to adjust via easy understandable menus, text and navigation. For simpler reading the menu choice **"Exit"** has been left out of description in this chapter intentionally. Whenever **"Exit"** is available, you can exit current menu and go back to the previous one visited. When there are no more previous menus available, the OSD menu overlay will be shut off and hidden. All settings are saved real-time or when you exit any menu (including time out of menu visibility).

The number shown in the "|-----x-----" line gives the indication of the submenu level where the function is located (also reference to the table in the previous chapter). It requires the user to touch the "MENU" symbol to enter that submenu.



Please note: Available functions described may deviate slightly from actual OSD menu on your unit. This is due to different OSD software configurations and customized solutions. Shown here are factory standards.

Input Source Settings

Lets you configure Main and Secondary signal source inputs (DVI, DisplayPort, VGA or Composite video signals) as well as activate or disable the Auto Source functionality. The contents of these submenus are listed below.

- Note: Switch time between sources is ~5 sec.

|---2--- Input Source Settings - Main Source

The possible signal inputs are; "Digital 1" (DVI), "Digital 2" (DVI), "Analog VGA1" (RGB/VGA), "Analog VGA2" (RGB/VGA), "Composite 1", "Composite 2", "Composite 3" (Composite Video) and DisplayPort 1 (DP). Composite Video inputs supports standard PAL/NTSC/SECAM signals.

- Note: The current active main source name will be greyed out in the list. By factory default, "Digital 1" (DVI) are assigned as Main Source. The current active main source will be shown in green color at the bottom of this menu.

|---2--- Input Source Settings - Second Source

The possible signal inputs are; "Digital 1" (DVI), "Digital 2" (DVI), "Analog VGA1" (RGB/VGA), "Analog VGA2" (RGB/VGA), "Composite 1", "Composite 2", "Composite 3" (Composite Video) and DisplayPort 1 (DP). Composite Video inputs supports standard PAL/NTSC/SECAM signals.

- Note: The current active secondary source name will be greyed out in the list. Also, if DVI, VGA or DP are defined as Main Source, they cannot be re-selected as second source as well. The second source is used together with Main Source for the Picture-in-Picture (PIP) functionality. PIP only works with one source of DVI/DP/VGA together with Composite Video sources. By Factory default "Composite 1 (Video)" are assigned as the second source. The current active main source will be shown in green color at the bottom of this menu.

Please note: Only one VGA Source can be defined as either Main or Single. Unit does not support dual VGA sources defined as Main+Source. Valid options are 1 x VGA + any of the other Digital based sources.

OSD Menu Functions

Input Source Settings - DVI-I1 Mode

This OSD setting item is used to select the DVI-I1 port operating mode.

Settings as follows:

- DVI Mode = The port is locked to DVI-D mode, only accepting digital input. "Analog RGB1" option in input source selection will be disabled.
- VGA Mode = The port is locked to VGA mode, only accepting analog input. "Digital 1" option in input source selection will be disabled.
- Auto Mode = The port can work in both DVI-D and VGA mode.

Note: For graphic cards that comes with DVI-I output, it is suggested to lock the operating mode to DVI mode or VGA mode. **By factory default, Single Link is supported.**

- Note: By factory default, this setting is configured as "Auto Mode".

Input Source Settings - DVI-I2 Mode

This OSD setting item is used to select the DVI-I2 port operating mode.

Settings as follows:

- DVI Mode = The port is locked to DVI-D mode, only accepting digital input. "Analog RGB 2" option in input source selection will be disabled.
- VGA Mode = The port is locked to VGA mode, only accepting analog input. "Digital 2" option in input source selection will be disabled.
- Auto Mode = The port can work in both DVI-D and VGA mode.

Note: For graphic cards that comes with DVI-I output, it is suggested to lock the operating mode to DVI mode or VGA mode. **By factory default, Dual Link is supported.**

- Note: By factory default, this setting is configured as "Auto Mode".

Input Source Settings - Auto Source Select

Set to either 'Enable' or 'Disable'. Signal is automatically searched for and selected. If the Main Source signal is disconnected physically, the video controller will automatically search and select from the next item available in the list, such as; "Digital 1" (DVI), "Digital 2" (DVI), "Analog VGA1" (RGB/VGA), "Analog VGA2" (RGB/VGA), "Composite 1", "Composite 2", "Composite 3" (Composite Video) and "DisplayPort 1" (DP).

- Note: If all signals are physically disconnected from the unit, the Auto Source function will loop endlessly until it detects a valid signal to display. By factory default, this setting is configured as "Enable".
- Switch time for next source is ~5 sec. The longest auto detection time is ~1minute from 1st source to last source.

OSD Menu Functions

Input Source Settings - Rename Source

By factory default, every signal source input are named based on it's signal property as described in the previous functions, but with the rename source function you can rename these into more understandable descriptions like; "FRONT-CAMERA", "NIGHT RADAR" etc. When activated, a requester on screen similar to a standard keyboard layout will appear. Use the "(-) Brilliance (+)", "(<) Navigation (>)" and "MENU" touch buttons to enter and edit the new name. Below is an example for editing the "Source" input name. Only uppercased letters allowed.

The "|<" button will erase (backspace) the last character entered. Press "Enter" to save new name.

Yellow border around letter indicate selected character.



OSD Menu Functions

Image Settings

Lets you configure various visual preferences for any signal. The contents of these submenu are listed below.

Image Settings - Auto Position

Will automatically fit the currently displayed full screen signal and center it based on the active area of the TFT display. This function relies on properties of the incoming signal.

- Note: This function will not try to scale or deform the image, so if the image looks stretched, please review the Management Setting/Scaling function later in this manual to adjust it on pixel level. Available for RGB/VGA mode only.

Image Settings - Auto Color Balance

Choose between "Yes" or "No". This function will automatically adjust the color balance of the currently displayed full screen signal. This function will analyse the incoming signal strength for RGB values and adjust it for "best eye visibility". Colors are automatically calculated based on an overall coloring model to attempt a more true, relevant and correct look. In general, you should display an image on screen while performing this action that contains variations of Red, Green, Blue, Black, White, Gray colors to get the best optimal balance of the current signal. An example is a test pattern image, similar to the picture illustrated later in the manual (see "Service - Test Pattern")

- Note: Available for RGB/VGA mode only.

Image Settings - Brightness

***Available in "Advanced" mode only**

Increase/decrease the black level saturation in real-time of the currently displayed full screen signal. Window overlays (PIP/PBP) and the OSD Menu overlay will be unaffected. A visual slider in the OSD menu will show the current value. This value adjusts the TFT panel's brightness by controlling the voltage feed.

- Note: Value adjustable from 0 to 255. 128 is factory default.

Image Settings - Contrast

***Available in "Advanced" mode only**

Increase/decrease the contrast in real-time of the currently displayed full screen signal. Window overlays (PIP/PBP) and the OSD Menu overlay will be unaffected.

- Note: Value adjustable from 0 to 255. 128 is factory default.

Image Settings - Saturation

***Available in "Advanced" only + Video Fullscreen**

Increase/decrease the overall video color saturation/color amount of the currently displayed full screen image (no effect on DVI/DP/VGA signals). Can be used if the incoming CVBS signal from older equipment (due to bad cables) appear to have a lack of strong colors or just to generally make the displayed image become more vivid. Note that this function can also make noisy color signals appear crisper/clearer if adjusted to gray scales.

- Note: Value adjustable from 0 to 255. 128 is factory default.

OSD Menu Functions

Image Settings - Hue

***Available in "Advanced" only + Video Fullscreen**

Allows you to adjust/shift the main color properties of all Red, Green, Blue and Yellow (unique hues) values. This can be useful for certain Composite Video sources (no effect on DVI/DP/VGA signals) whose output may have shifted or seems to be "out of phase", where for instance blue seems more dominant than green, red and yellow-ish colors. By using HUE one can shift the entire color range of all components left or right in the spectrum.

- Note: Value adjustable from 0 to 255. 128 is factory default.

Image Settings - Sharpness

Increase/decrease the overall image sharpness. This affects the active display area, and applies to all signal inputs and window overlays (PIP/PBP). Use it to increase the visual quality of signals from older equipment or improve electronically weak signals.

- Note: Value adjustable from 0 to 24. 12 is factory default. Available in RGB/VGA, CVBS modes only.

Image Settings - Display

Allows you to adjust DVI/DP/VGA signals Horizontally (left/right) and Vertically (up/down) within the TFT panel Active Area. If the incoming signal is "Analog VGA" (RGB/VGA) only, Clock and Phase can also be adjusted (if there seems to be a "waterfall / rolling bars" effect present in the active display area).

- Note: This function can move information in the image outside the visible TFT Active Area, so use caution when modifying this parameter. Try to determine the max end of borders (look at each corner) of the image before you proceed using this function.

Image Settings - Display - H Position

Settings as follows:

"H Position" = Move image within the TFT panel active area Horizontally (left/right), values from 0 to 100.

- Note: Factory Default value (50) is centered inside the active TFT panel area.

Image Settings - Display - V Position

Settings as follows:

"V.Position" = Move image within the TFT panel active area Vertically (up/down), values from 0 to 100.

- Note: Factory Default value (50) is centered inside the active TFT panel area.

OSD Menu Functions

Image Settings - Display - Clock

Adjust the horizontal frequency (clock) of the analog signal to improve visibility of the entire image. When it is adjusted, you will notice that the image will appear to be stretched and might in some situations start to flicker/scroll, at which point you must reverse the last adjustment to stop it from flickering/scrolling anymore. This function can be used for older signals that is not automatically detected by the internal display controller.

To adjust the Clock and Phase to an optimal setting it is recommended to display an image with alternating white and black lines by stepped by 1 pixels either vertically or horizontally. It is suggested to use a dedicated and external test pattern while adjusting. Values from 0 to 100.

- Note: Available for RGB/VGA mode only.

Image Settings - Display - Phase

Fine tune the data sampling position of the signal (impacts on image quality). This function will remove small transparent defects in typical characters where a portion seems to be more faint than the nearby black pixels. The faint pixels are always visible as a line from top to bottom (vertically). Note that this function is automatic and does not allow for manual values. It is suggested to use a dedicated and external test pattern while adjusting. Values from 0 to 63.

- Note: Available for RGB/VGA mode only.

Image Settings - Display - Picture Direction

Choose between "0" and "180" degree rotation. 0 is normal view (Landscape), while 180 will rotate image to appear upside down (flipped vertically). Factory default setting is "0" (Landscape).

OSD Menu Functions

Image Settings - Video Setup

***Available when Video Fullscreen only**

Provides submenus where the following settings for Composite video signals are available:

Image Settings - Video Setup - Main MADI mode

Motion Adaptive De-Interlacing. Motion adaptive de-interlacing is a pixel-based two-phase process. Phase 1 involves the detection of motion and the generation of a motion value for each pixel. These pixel motion values are used as a measure of the current "degree of motion". In Phase 2, the pixel motion values are used to select the appropriate de-interlacing technique. As a result, areas of an image that are not moving will be fully static (flicker free) and moving objects will have smooth edges.

Set to either "Normal", "Adaptive" or "OFF".

- Note: Default is OFF

Image Settings - Video Setup - Noise Reduction

The media noise reduction block removes unwanted ringing and block noise from images that have undergone MPEG or JPEG compression and decompression. The two types of media noise that can be reduced are:

- Block Noise: MPEG encoders, in the presence of an almost flat area, can create a squared structure due to the discrete 8x8 squares that are used in the MPEG compression process. This creates a noticeable squared structure in the image. The process smoothens these square boundaries so they are not visible. The amount of smoothing is programmable between neighboring pixel values that will be smoothed. The amount of smoothing starts to decrease linearly from the maximum (defined by TO) to 0 (defined by 2 x TO) to avoid the hard switch effect of the smoothing applied.
- Mosquito Noise: This process smoothens checker box and discrete noise artifacts referred to as Mosquito Noise around large edge transitions caused by MPEG encoders.

This submenu will give you the following choices:

Image Settings - Video Setup - Noise Reduction - Dynamic NR Mode

Dynamic NR (Noise Reduction) Mode can be set to either "High", "Medium", "Low", "Adaptive" or "OFF". This is the "strength" of how much noise to detect and automatically remove in order to enhance the overall image quality. The Block Noise process will be used.

- Note: Default is OFF

OSD Menu Functions

4 Image Settings - Video Setup - Noise Reduction - MPEG NR Mode

MPEG NR (the generic coding of moving pictures and associated audio information) can be set to either "ON" or "OFF". This function will try to reduce noise as result from compressed/formatted MPEG video streams. This noise is often seen as larger blocks or containers of compressed pixels and is suitable to improve the visual performance of video feeds capable of outputting direct MPEG streams. The Block Noise process will be used.

- Note: Default is OFF

4 Image Settings - Video Setup - Noise Reduction - Sharpness Noise Coring

Adjust the clarity after Noise Reduction was applied to the video signal. Can be set to "High", "Medium", "Low", "Adaptive" or "OFF". The Mosquito Noise will be used.

- Note: Default is OFF

3 Image Settings - Video Setup - Film Mode

This function will analyze the resolution and frames per second information in the video feed and determine how to process/display each frame correctly (to avoid judder and staggering playback), also referenced as "pull down method". This option should be chosen to secure that the video feed is at maximum quality and performance. 2:2 is suitable for PAL/SECAM signals, while 2:3 is suitable for NTSC signals. 2:2-2:3 will try to conform to both standards and may be suited in some cases for mixed incoming video feeds. 3:2 film enables sequences of 24 Hz original film content and convert this to an output of 48 Hz or 72 Hz vertical refresh rate. This feature reduces the noticeable uneven judder seen on a 3:2 film sequence that is converted to 60 Hz vertical refresh rate.

Set to either; "2:2", "3:2", "3:2-2:2" or "OFF".

- Note: Default is OFF

3 Image Settings - Video Setup - DCDi

DCDi® BY Faroudja low-angle Diagonal interpolation. In addition to the advanced de-interlacing capabilities mentioned in the previous sections, further image enhancement is achieved by applying special processing to a moving low angle diagonal pattern in a video image. For motion video, the intra-field interpolation is done using the patented and highly acclaimed DCDi® (Directional Correlational De-Interlacing) algorithm by Faroudja®. Conventional Interpolation algorithms operate on the basis that the current pixel is related to the pixels above and below it. This is untrue of diagonal edges. Whenever an edge is not vertical, the way the current pixel depends on the angle of the edge is related to those diagonally above and below it. Hence, conventional vertical Interpolation algorithms work well on edges close to the horizontal and vertical directions. However, they will break down completely as the angles of edges become more diagonal, causing jagged edge artifacts. DCDi® by Faroudja computes and tracks the angles of edges and uses this information to optimally fill in the missing pixels, removing jagged edge artifacts.

Set to either "ON" or "OFF".

- Note: Default is OFF

OSD Menu Functions

Color Mode Settings

Lets you adjust the color temperature (Kelvin degrees) of the image. This applies to the Main Source signal. Window overlays (PIP/PBP) and the OSD Menu overlay will be unaffected. Lower values make the image appear warmer, while higher values will make it appear cooler. The contents of these submenus are listed below.

Illustration (does not appear in menu): The Kelvin color temperature scale (approximate and symbolic):



|---2--- Color Mode Settings - Color Temperature

Set to either "9300K" (Cool, a blueish white), "8000K" (Neutral, a white close to natural light), "6500K" (Warm, a reddish white) or "User", (only available when Full Menu is active).

|-----3----- Color Mode Settings - Color Temperature - User

Allows individual adjustment of Red, Green and Blue color gains. The selected setting will be saved for each signal input respectively.

- Note: Value adjustable from 0 to 255. 128 is factory default.

|---2--- Color Mode Settings - Gamma

***Available in "Advanced" only + Video Fullscreen**

This will activate the stored gamma curve color compensation as well as the LED indicators or backlight brilliance used with ECDIS. Set to either "No Calibration", "Calibration VGA", "Calibration DVI" or "Calibration DisplayPort", where these represents the two storage locations for compensation data. When either of them are active, they will override the color temperature setting for the signal channel. Different signal channels can be set to different settings that will be saved.

This function is suitable for use with external equipment. Color temperature will be disabled.

- Note: Default is "No Calibration" with Gamma 2.2 and 140nits.

OSD Menu Functions

Multi-PIP Settings

Lets you adjust how the Picture-in-Picture (PIP) or Picture-by-Picture (PBP) display modes are set up. The default position of the rectangle is set to the upper left corner of the Active Display area. Note that this requires a valid incoming signal to be present in any of the "DVI", "DisplayPort", "VGA" or "Composite" inputs. The contents of these submenus are listed below.

Valid combinations of Picture-in-Picture (PIP) and Picture-by-Picture (PBP):
 Gray = Same. **Red = Not possible.** **Green = OK.**

Main >	DVI1	DVI2	VGA1	VGA2	Composite1	Composite2	Composite3	DisplayPort
Second								
DVI1	Gray	Green	Red	Green	Green	Green	Green	Green
DVI2	Green	Gray	Green	Red	Green	Green	Green	Green
VGA1	Red	Green	Gray	Red	Green	Green	Green	Green
VGA2	Green	Red	Red	Gray	Green	Green	Green	Green
Composite1	Green	Green	Green	Green	Gray	Red	Red	Green
Composite2	Green	Green	Green	Green	Red	Gray	Red	Green
Composite3	Green	Green	Green	Green	Red	Red	Gray	Green
DisplayPort	Green	Green	Green	Green	Green	Green	Green	Gray

Multi-PIP Settings - PIP Mode

Settings as follows:

"PIP OFF" = Function is inactive and other settings can not be accessed.

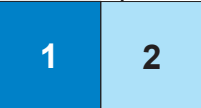
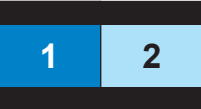
<p>"PIP Child"</p> 	<p>The Secondary Source will be displayed in a small frame as an overlay over the Main Source signal. When this function is activated a new menu item will appear under "PIP Mode" called "PIP Display". Known as "Picture-In-Picture (PIP)".</p>
<p>"PIP Split"</p> 	<p>The Main Source and Secondary signal sources are shown side-by-side with the Main Source to the left and the Secondary Source to the right. Note: Both sources will be stretched to fill screen. If aspect ratio is needed, consider PIP Wide function below, or set the sources to match 50% resolution of the native display. Example: If native TFT panel has 1920 x 1024 resolution, sources must be set to 960 (wide) x 512 (height) to appear correctly (aspect ratio).</p>
<p>"PIP Wide"</p> 	<p>The Main Source and Secondary signal sources are shown side-by-side in widescreen mode with the Main Source to the left and the Secondary to the right. Aspect Ratio of souce signals are preserved.</p>

- Note: Default is OFF

OSD Menu Functions

Multi-PIP Settings - PIP Display

***Available only when PIP Mode on**

When PIP Child mode is active, the size and position of the rectangle displaying the Secondary Source can be adjusted via the submenus below. Secondary Source needs to be a valid signal source.

Multi-PIP Settings - PIP Display -- PIP Child Size

Settings as follows:

"PIP Size" = Adjust the full size (H and V) for Secondary Source, values from 1 to 9. Factory Default is 9.

"PIP H-Size" = Adjust the Horizontal size for Secondary Source, values from 0 to 20. Factory Default is 10.

"PIP V-Size" = Adjust the Vertical size for Secondary Source, values from 0 to 20. Factory Default is 10.

- Note: Default value for all 3 functions is 0.

Multi-PIP Settings - PIP Position

When PIP Child mode is active, the size and position of the frame displaying the Secondary Source can be adjusted by means of submenus for size and position respectively below.

Settings as follows:

"PIP H-Position" = Adjust the Horizontal (left/right) position for Secondary Source, values from 0 to 100. Factory Default is 50.

"PIP V-Position" = Adjust the Vertical (up/down) position for Secondary Source, values from 0 to 100. Factory Default is 50.

Multi-PIP Settings - Swap Source

Swaps the Main and Secondary source signals (if present) including adjustments you may have made, meaning that whatever is in Main Source will become the contents of the defined PIP rectangle, and contents of the PIP rectangle to become full screen.

- Note: You can also assign the Swap Source to the Hotkeys. Review "OSD Settings - Hot Key Assignment / Swap Source" section later in this manual.
- Note: Switch time between Main and Secondary source is ~5 sec.

When PIP mode is active, the picture appearance of the Secondary Source can be adjusted via the following settings:

Settings as follows:

- "Brightness" = Adjust the black level (brightness) of the Secondary Source, values from 0 to 255. Factory Default is 128.
- "Contrast" = Adjust the contrast of the Secondary Source, values from 0 to 255. Factory Default is 128.
- "Saturation" = Adjust the overall color intensity of the Secondary Source, values from 0 to 255. Factory Default is 128.
- "Hue" = Adjust the Hue color properties of the Secondary Source, values from 0 to 255. Factory Default is 128.
- "Sharpness" = Adjust the sharpness of the Secondary Source, values from 0 to 24. Factory Default is 12.

OSD Menu Functions

OSD Miscellaneous

Allows you to customize the visual appearance of the On Screen Display (OSD) menu, such as; position, transparency, time-out, assign hot keys, define access modes and save, load and recall favourite settings and more. The contents of these submenus are listed below.

OSD Miscellaneous - OSD Position

Settings as follows:

"OSD H. Position" = Place the OSD menu overlay Horizontally (left/right), values from 0 to 255.

"OSD V. Position" = Place the OSD menu overlay Vertically (up/down), values from 0 to 255.

- Note: Default position of the OSD menu overlay is in the lower left corner of the of the Active Display area. Default value for both functions is 255.

OSD Miscellaneous - Language

Available OSD language to be used for all text and warnings that may appear.

Settings as follows:

"Norsk" = Display OSD in Norwegian.

"English" = Display OSD in English.

"Français" = Display OSD in French.

"Deutsch" = Display OSD in German.

"Italiano" = Display OSD in Italian.

"日本語" = Display OSD in Japanese.

"簡體中文" = Display OSD in Simplified Chinese.

- Note: Current selected language is shown in green color. Default language is English.

OSD Miscellaneous - Presets

Allows you to work with Memory Presets (Recall/Save/Load) for OSD menu settings and overlays. The contents of the submenu is listed below.

Settings as follows:

"Recall" = Reset back to factory defaults. Will override and restore all previous modified settings.

OSD Menu Functions

OSD Miscellaneous - Preset Save - Save

Allows you to save current state of all function and values to user defined presets. The contents of the submenu is listed below.

Settings as follows:

"User 1"	= Save all OSD settings to User 1 slot.
"User 2"	= Save all OSD settings to User 2 slot.
"User 3"	= Save all OSD settings to User 3 slot.
"User 4"	= Save all OSD settings to User 4 slot.
"User 5"	= Save all OSD settings to User 5 slot.

OSD Miscellaneous - Preset Save - Load

Allows you to load current state of all function and values to user defined presets. The contents of the submenu is listed below.

Settings as follows:

"User 1"	= Load all OSD settings from User 1 slot.
"User 2"	= Load all OSD settings from User 2 slot.
"User 3"	= Load all OSD settings from User 3 slot.
"User 4"	= Load all OSD settings from User 4 slot.
"User 5"	= Load all OSD settings from User 5 slot.

OSD Miscellaneous - OSD Timeout (Sec)

Adjust the timeout in seconds that the OSD menu overlay is automatically exited and hidden from view including locking mode (see OSD Lock Mode/Advanced Mode on next page). This timeout is counted from last activity (navigation or adjusting parameters). The value is adjustable from 0 to 30 seconds.

- Note: Default timeout value is 10 seconds.

OSD Miscellaneous - OSD Transparent

Adjust the alpha blend also known as transparency of the OSD Menu overlay. It means that all signal inputs and PIP/PBP images show through the OSD Menu. It is used when important information on the display is necessary to be visible at all times.

- Note: Level adjustable from 0 to 7. 0 is factory default (no transparency/solid background color).

OSD Miscellaneous - OSD Mode

Configuring the OSD Menu access based on most common functions to service/troubleshooting.

Settings as follows:

- "Basic" = A few functions is not visible/available in this state. For most uses this is the preferred setting and are safe for the display functionality and continuous trusted operation on the unit.
- "Advanced" = All functions and parameters is visible/available in this state. Some of the settings adjusted could impact on display functionality and image quality. Only experienced and qualified personnel should access and change parameters when in this mode. Also, more technical details about signals, frequency will be available.
- "Service" = Only applicable for authorized service personnell. Key code is available from Hatteland Technology service network / HelpDesk.

- Note: Learn how to navigate and enter the correct code, by reading the "OSD Keycode / OSD Lock Mode" introduction section in the previous chapter.
- Note: When requesting "Advanced" mode from "Basic" mode, the user is required to enter a key code. This code is factory preset to "362". You can enter the code by using navigation and "MENU" to confirm. After a successful entering of the key code, the OSD menu will always be in this state during powered on. After a power off and on to the unit, the OSD Mode will be reverted back to "Basic" mode.

OSD Miscellaneous - OSD Lock Mode ***Available in "Advanced/Service" mode only**

To prevent accidental or unwanted user intervention, you can set the behaviour of how the OSD menu is accessible by the user including adjusting brightness via the "(-) Brilliance (+)" symbols. Normally by factory default accessible by pressing the "MENU" function on the front (user controls).

Settings as follows:

- "Normal Mode" = Default accessible pop-up by touching the "MENU" symbol. For Non-ECDIS Compliant usage.
- "Menu Protect" = Ask for key code first (321) when the "MENU" symbol is touched on the front glass and before the OSD menu will appear. Required for ECDIS Compliance usage.
- "Full Protect" = When activated: You will have to press the "MENU" symbol for 5 seconds after which the key code requester will appear. Note that only the "MENU" symbol will activate the password request, all other touches on other symbols are ignored. After key code was entered and accepted, the OSD menu will appear in which case you have "x" seconds to use brilliance and power functions before all functions are deactivated again and returns to "Advanced Mode".

"x" value is defined as OSD Timeout value (see previous page).

- Note: Learn how to navigate and enter the correct code, by reading the "OSD Keycode / OSD Lock Mode" introduction section earlier in this chapter.

OSD Miscellaneous - Hot Key Assignment *Available in "Advanced/Service" mode only

|---2---

Assign a commonly used OSD menu function to the available touch enabled Hot Keys which are located on the front of unit (user controls). The following functions are available to assign and most of them have a negative and positive counting logic. All of these functions are described before and after this segment in the manual.

Settings as follows (for both "Key 1" and "Key 2"):

"OSD Language" = Flip up/down through available languages (real-time changes).
Reference in user manual: "OSD Settings / Language"

"Test Pattern" = Display the internal test image overriding any signal inputs. Both Hot Keys performs the same action.
Reference in user manual: "Service Settings / Test Pattern"

"Swap Source" = Swap the Main Source and Secondary Source appearance. Both Hot Keys performs the same action.
Reference in user manual: "Input Source Settings / Swap Source"

"Graphic Scaling" = Flip up/down through the scaling methods available.
Reference in user manual: "Management Settings / Graphic Scaling / Graphic Scaling"

"PIP Mode" = Flip up/down through the PIP/PBP functions. Note: Only when PIP is active. Does not work for Fullscreen.
Reference in user manual: "Multi-PIP Settings / PIP Mode"

"Second Source" = Flip up/down through the available signal sources (to PIP/PBP) for Second Source.
Reference in user manual: "Multi-PIP Settings"

"Main Source" = Flip up/down through the available signal sources (to full screen) for Main Source.
Reference in user manual: "Multi-PIP Settings"

"PIP Child Size" = Increase/Decrease the size of the Picture-In-Picture overlay.
Reference in user manual: "Multi-PIP Settings / PIP Display / PIP Child Size"

"Black Level" = Increase/Decrease Brightness of the TFT panel (not backlight).
Reference in user manual: "Image Settings / Brightness"

"No Function" = Nothing will be activated when user presses Hot Keys on the front. Both Hot Keys performs the same action.

- Note: Default Hot Keys are assigned to "No Function". You can assign different functions to "Key 1" and "Key 2".

OSD Menu Functions

OSD Miscellaneous - OSD Key Outdoor ***Available in "Advanced/Service" mode only**

To prevent accidental activation of Glass Display Control™ (GDC) touch functions, you can add an extra layer of security on how "sensitive" the touch detection operates. This applies for "MENU", "(-) Brilliance (+)" and "Power Off" functions. The OSD Key Outdoor function is especially effective if the unit is located where handheld UHF radio is commonplace or in a outside environment where rain drops could potentially trigger touch button functions. Note that this setting does not apply for fullscreen sized touch screen glasses.

The OSD Key Outdoor function has an added UHF protection for the uC (FW) Firmware version 0A27 and higher. When OSD Key Outdoor is ON, it will continuously detect for UHF frequencies and try to block these.

Settings as follows:

"Off"	= All touch symbols operates normally. Factory Default setting.
"On"	= Touch symbols responds when you press and hold it for 5 seconds*

*Button presses will then operate normally until it has detected no button presses for 6 seconds (timeout period). After timeout period the OSD Key Outdoor setting will revert back to 5 seconds "press and hold" behaviour.

For more information, please review appendix chapter "UHF Interference Prevention" later in this manual

OSD Miscellaneous - Spectrum

Function only applicable for customized solutions.

- Note: Adjustable from 0 to 512. 0 is factory default.

OSD Miscellaneous - Keep OCM Mode ***Available in "Service" mode only**

If signal input is not detected or disconnected, the unit will enter Deep Sleep Mode. In this mode, no MCC commands are processed if sent to unit. If MCC commands are needed, simply set the "Keep OCM Mode" function to "ON". The unit will now respond to MCC commands, even without any detected signal input or signal cable connected to unit.

Additionally, when function is chosen to be "Off", the GDC symbols (Brightness, GDC buttons) on front will automatically fade away after 10s inactivity detected on incoming signal (signal lost, connected computer shutdown, cable detached etc.). If function is chosen to "On", the GDC symbols will illuminate constantly.

Settings as follows:

"Off"	= Factory Default setting, will enter Deep Sleep Mode. No MCC commands are processed (ignored). GDC symbols (Brightness, GDC buttons) on front will automatically fade away after 10s.
"On"	= Disables the Deep Sleep Mode and enables detection and processing of MCC commands. GDC Symbols will not fade away.

OSD Menu Functions

Management Settings

Allows you to adjust overall settings for interaction/communication for the unit, such as scaling, zoom, timing of signals, sensitivity for the touch control, VGA filter and Serial/Ethernet communication and more. The contents of these submenus are listed below.

|---2--- Management Settings - Graphic Scaling *Available in "Advanced" mode only

Allows you to scale the currently displayed full screen signal in various ways. The contents of the submenus is listed below.

|-----3----- Management Settings - Graphic Scaling - Graphic Scaling

All scaling will performed from center of active display area and outwards in all directions.

Settings as follows:

- | | |
|------------------------|--|
| "Full Screen" | = Zoom current full screen signal to fill the entire active display area. Aspect ratio is ignored, which means that picture may appear distorted or stretched. |
| "Fill to Aspect Ratio" | = Zoom current full screen signal to fill the entire active display area and preserve the aspect ratio. This means that you may notice black bars without any image information either on top/bottom or left/right of the centered image. |
| "One To One" | = Zoom current full screen signal to fill the entire active display area as 1:1 native pixel resolution. Example; if the incoming signal is a 800x600, on a 1600x1200 unit, the incoming signal will be shown 50% less in size and centered on screen. Aspect ratio is kept unchanged. |

|-----3----- Management Settings - Scaling - Zoom

All zooming will performed from center of active display area and outwards in all directions.

Settings as follows:

- | | |
|--------|---|
| "Zoom" | = Zoom the current full screen signal horizontally and vertically in equal steps. Values from 0 to 100. |
|--------|---|

- Note: Values under or over 50, may cause blurry and unfocused imagery, since it overrides the external signal's 1.1 pixel information and properties. Factory Default value is 50.

Management Settings - Graphic Scaling - Horizont Stretch

All stretching will performed from center of active display area and outwards in one direction.

Settings as follows:

"Horizont Stretch" = Zoom/stretch current full screen signal in Horizontal direction only (left and right). Values from 0 to 100.

- Note: Values under or over 50, may cause blurry and unfocused imagery, since it overrides the external signal's 1.1 pixel information and properties. Factory Default value is 50.

Management Settings - Graphic Scaling - Vertical Stretch

All stretch will performed from center of active display area and outwards in one direction.

Settings as follows:

"Vertical Stretch" = Zoom/stretch current full screen signal in Vertical direction only (up and down). Values from 0 to 100.

- Note: Values under or over 50, may cause blurry and unfocused imagery, since it overrides the external signal's 1.1 pixel information and properties. Default value is 50.

Management Settings - Auto Adjustment

Allows you to let the video controller always perform a Automatic Adjustment based on the detected properties in the incoming signal or when incoming signal sources changes it's properties real time. It will scale and position incoming signal sources that has changed since the last detection was executed successfully. Set to either "ON" or "OFF".

- Note: This function is the same as the manual function found in "Image Settings - Auto Position" earlier described. Default value is "OFF".

OSD Menu Functions

Management Settings - Unknown Timing Search *Available in "Advanced" mode only

Use this if you are unable to find or detect the incoming full screen signal automatically (applies for Analog VGA and CVBS video signals only. A PIP or PBP configured signal is not supported). It may be a customized signal regarding resolution and refresh frequency. In these situations the custom signal sources can be searched upon or entered manually within the OSD menu and even stored conveniently. The contents of these submenus are listed below.

Management Settings - Unknown Timing Search - Auto Mode

Try to determine the incoming signal by automatic detection routines which is based on a known list of properties for resolutions and frequency combinations that fall out, but between the most common industry standard set of resolutions/refresh frequencies.

Settings as follows:

- | | |
|----------------|--|
| "Display Size" | = Force the Aspect Ratio to either to 4:3, 5:4, 1:1, 16:9 or 16:10 |
| "Execute" | = Choose to produce timing table, update the "Blind Mode Data" and refresh the screen condition using the data of the timing table. If this procedure seem to fail, use the "Blind Mode" below to enter values manually. |

Management Settings - Unknown Timing Search - Blind Mode

If you know the advanced properties of the incoming signal or want to troubleshoot a possible detected signal (that seem to have small deviations), you may try to adjust the values below and see the result in real time. These settings should be performed by a skilled technician or a individual that has the needed knowledge to do so. Internally these settings below are saved into a data register called "Timing Table".

Settings as follows:

- | | |
|-------------------|---|
| "H. Resolution" | = Set the Horizontal resolution of the timing table.
Values from 0 to 2000. |
| "V. Resolution" | = Set the Vertical resolution of the timing table.
Values from 0 to 2000. |
| "Total H. Line" | = Set the Total Horizontal Lines of the timing table.
Values from 0 to 2000. |
| "H. Blank Pixels" | = Set the Horizontal Start of timing table,
(sync pulse + back porch). Values from 0 to 500. |
| "V. Blank Pixels" | = Set the Vertical Start of timing table,
(sync pulse + back porch). Values from 0 to 500. |
| "Execute" | = Choose to produce timing table and refresh the screen condition using the data of the timing table. |

- Note: You may experience fast, slow flickering or sliding lines during adjustments. This is normal, and gives the indication that a different setting may have to be adjusted also, since all these functions are connected to each other in order to create a stable signal that the video controller can display correctly.

OSD Menu Functions

Management Settings - Unknown Timing Search - Save Timing

The current "Timing Table Data" that is currently visible in the "Blind Mode" or via the "Auto Mode" functions may now be saved to a user defined slot. Available save slots from 1 to 8. Saving "Time Table Data" may prove to be useful until the external equipment is either replaced or changed. If so, you should use the "Clear Timing" function below to remove any obsoleted "Timing Table Data" from time to time. Factory Default save slot is 1.

Management Settings - Unknown Timing Search - Clear Timing

Will allow you to clear "Timing Table Data" currently saved / or not saved, based on the "Save Timing" function above. You may clear save slots 1 to 8. Factory Default slot is 1.

Management Settings - GDC Sensitivity

***Available in "Advanced" mode only**

The touch enabled symbols known as GDC (Glass Display Control™) available on the front glass of the unit can be adjusted in sensitivity. It basically means that a small value requires a larger area to be covered longer over time, while a large value will require less smaller area to be covered in less time. If you set the value too low or too high, you may feel a difference in either increased responsiveness or the lack of such. By factory default the value is set to 150.

Settings as follows:

"GDC Sensitivity" = Adjust values from 0 to 255.

- Note: Default is model dependent and set by factory. Note that the difference between 0 and 100 is minimal, as it is not suitable to go beyond a fair responsiveness that could cause accidental triggering of functions to occur by nearby objects touching the glass (i.e. rain drops for instance, washing glass with cloth).
- Caution: If the sensitivity value was set very low, you may experience an increased occurrence of non-responsiveness which also affects accessing the correct menu function in order to re-adjust this value. It is therefore suggested as a last resort solution to reset this value via SCOM (Serial/Ethernet Communication) functionality instead by sending a "Reset Factory Default" (or "Load User Default"+Slot Number, if available and previously stored by using "Save User Default"+Slot Number) commands if you are unable to navigate the OSD menu.

Please review the appropriate Technical User Manual located here:
<https://www.hattelandtechnology.com/hubfs/pdfget/inb100018-6.htm>

Management Settings - Filter

***Available in "Advanced" mode only**

Filter (applies for VGA1 signal input only) is a Signal Noise Reduction technique to enhance a possible weak or bad RGB/VGA signal. It will remove certain types of noise patterns typically apparent in close proximity of other electronic equipment with less or lack of proper shielding to prevent interference.

Settings as follows:

"Filter" = Set to either "Enable" or "Disable".

- Note: Default is "Disable"

The unit allows for remote control (adjust brightness for example) and/or accessing internal information about the unit such as typenumber, serial number and more. To setup this feature, you first need to configure the Serial, Ethernet or USB protocol properly to match your external equipment specifications. The contents of the submenus is listed below.

Settings as follows:

"RS232"	= Sets the internal communication to standard RS-232 protocol.
"2-wire RS-485"	= Sets the internal communication to RS-485 protocol (Half duplex).
"4-wire RS485/422"	= Sets the internal communication to RS-485/422 protocol (Full duplex).
"Address RS"	= Set the global unique channel/port ID for the unit (range 0-254).
"IP Address"	= IP can be found Automatically or you can set the IP address manually (xxx.xxx.xxx.xxx) for Ethernet protocol by choosing "Fixed IP".
"USB"	= Sets the internal communication to standard USB protocol.
"Enable RS232 FW" "Download"	= Allows Factory Firmware upgrade for the unit via RS-232 Serial Communication.

- Note: Default mode is "RS232" protocol.

A more detailed description of the SCOM (Serial/Ethernet Communication) can be found here:

<https://www.hattelandtechnology.com/hubfs/pdfget/inb100018-6.htm>

Review also the "Pinout Assignments" chapter in this manual for additional help during preparation and/or installation of external equipment intended to communicate with.

Management Settings - Power Plan

***Available in "Advanced" mode only**

|---2---

This setting will allow you to control the power mode of USB/VGA out and Ethernet port in Power off mode.

Settings as follows for "VGA Out/USB in Off Mode":

"Enable" = Enabled in power off mode.
"Disable" = Disabled in power off mode.

- Note: Factory Default set to "Enable"

Settings as follows for "LAN in OFF/Sleep Mode":

"Enable" = Enabled in power off mode.
"Disable" = Disabled in power off mode.

- Note: Factory Default set to "Enable"

Management Settings - Touch Power Enabled

***Available in "Advanced" mode only**

|---2---

This setting will allow you to filter the signal processing from touch screen to reach the computer. For instance, if user only want touch screen to be active when DisplayPort signal is defined as Main Input, but disallows touch screen processing on other signal inputs, the non-touch screen enabled signal inputs would require the user to operate elements on screen either with keyboard, mouse or just for information purposes only with no user interaction possible via touch screen.

Settings as follows:

"Always Active" = Touch is always enabled, even if there are no image on screen. Display unit may be powered off, but require power cable connected as well as a powered on computer. Signals from touch screen will still reach the computer.

"Any signal is On" = Touch is enabled when any input is active as Main Input.

"Select signal is On" = Following list and Choices available:

"Digital 1" = Touch is enabled only when DVI 1 is active as Main Input.
"Digital 2" = Touch is enabled only when DVI 2 is active as Main Input.
"Analog RGB 1" = Touch is enabled only when VGA is active as Main Input.
"Analog RGB 2" = Touch is enabled only when VGA is active as Main Input.
"Composite 1" = Touch is enabled only when Composite 1 is active as Main Input.
"Composite 2" = Touch is enabled only when Composite 2 is active as Main Input.
"Composite 3" = Touch is enabled only when Composite 3 is active as Main Input.
"DisplayPort" = Touch is enabled only when DisplayPort is active as Main Input.

- Note: Factory Default set to "DisplayPort"

OSD Menu Functions

|---2---

Management Settings - External Power Button ***Available in "Advanced" mode only**

This setting will allow you to manually enable the use of an external power button to turn off the Display unit. Please review the Pinout Assignments (Potmeter Control 9-pin DSUB MALE Connector) for connectivity.

Settings as follows:

"Enable" = Key press from External power button detection enabled.
"Disable" = Key press from External power button detection disabled.

- Note: Factory Default set to "Disable"

|---2---

Management Settings - DDC/CI Setting ***Available in "Advanced" mode only**

This setting will allow user to enable and set which signal input where DDC/CI display control communication will occur. For more information about DDC/CI, please review the "Operation Advanced (DDC/CI) Control Overview" chapter in this manual.

The possible choices are: "Digital 1" (DVI), "Digital 2" (DVI), "Analog RGB 1" (VGA), "Analog RGB 2" (VGA), "DisplayPort 1" (DP) and "None".

- Note: Factory Default set to "None"

OSD Menu Functions

Service Settings

Will show various technical and unit related information, such as; Firmware versions, Elapsed Time, Internal Temperature, Fault Status and activation for the internal Test Pattern image useful for trouble-shooting. Some of these functions are static information while others are accessible. Whenever you are in contact with helpdesk or service, they might require you to read back some of these values in order to precisely pinpoint any problem/question you should have with the unit or its functionality.

Information blocks as follows:

"Video Scaler Firmware"	= Displays the firmware version of the internal videocontroller. Example: "FW200001-0BV2"
"uC Firmware"	= Displays the firmware version of the touch enabled buttons. Example: "FW100002-0A12"
"Elapsed Time"	= Shows the time elapsed in hours since first-time power on. Example: "180"
"Current Temp"	= Shows the internal temperature measured by onchip sensor. Example: "+027.0 C", in Celcius Degrees.
"Fault Status"	= Will show detected Fault Status by measuring various internal values. Status is stated as either "OK" or "FAULT" Note: This item is only visible in "Advanced" menu mode.

Service - Fault Status

*Available in "Service" mode only

Will show detected Fault Status by measuring various internal values during operation. Status is stated as either "OK" or "FAULT". The contents of this submenu is listed below.

Fault Status as follows:

"NVRAM"	= Status for Non-volatile random-access memory, used to store parameters and settings.
"Ethernet"	= Status for Ethernet/LAN communication chip controller.
"GDC"	= Status for Glass Display Control™ (GDC) touch button controller.
"TMP Sensor"	= Status for internal temperature measured by on-chip sensor.
"Video Scaler"	= Status for on-board Digital Visual Interface graphics chip processor.

OSD Menu Functions

Service Settings - Test Pattern

Will show the internal test pattern with greyscales, colors and raster patterned boxes to check for deviations in the TFT panel/display controller behaviour. It is independent of any current resolution or specifications found in the signal inputs. The test pattern is generated internally in the display controller and is sent 1:1 directly to the TFT panel. It can be useful during trouble-shooting situations to determine the source of a display or connectivity problem regarding external equipment.

To activate this function, touch the "MENU" button.

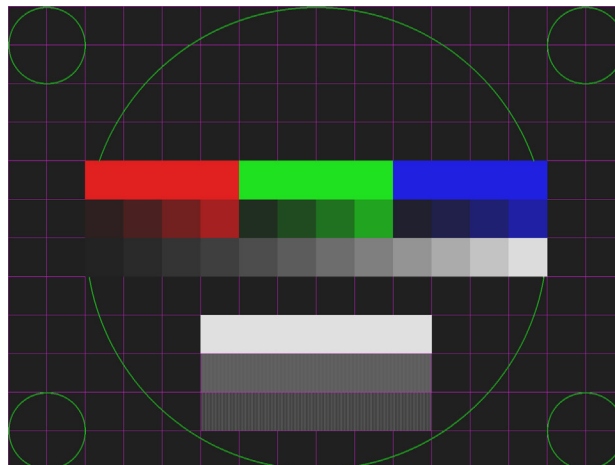

- Note: This function will not inform/report any deviations directly, you need to have the required technical expertise to interpret the test pattern displayed.

Service Settings - Burn In

***Available in "Service" mode only**

Used to Warm up the panel with full-screen solid color. For internal testing purposes only. Please contact your nearest Hatteland Technology or Service Partner before using this setting.

Service Settings - Smart ISP

***Available in "Service" mode only**

Used for Video Scaler firmware update. For experienced personell only, please contact Hatteland Technology or Service Partner for more information.

Service Settings - Watchdog Test

***Available in "Service" mode only**

Used for internal testing only. For experienced personell only, please contact Hatteland Technology or Service Partner for more information.

This page left intentionally blank



Operation Advanced (DDC/CI)

Operation Advanced (DDC/CI) Control Overview

Introduction

DDC/CI (Display Data Channel/Command Interface) specifies a means for a computer to send commands to the unit's Display Video Controller to programmatically adjust parameters of the display instead of pressing physical buttons or navigate through an OSD menu. Specific commands to control units are defined in a separate official Monitor Control Command Set (MCCS) industry standard. The signal inputs supported are DVI*, HDMI, DisplayPort (DP) and VGA*.

To determine if your unit has the DDC/CI commands supported as described in this chapter, please review the "On Screen Display (OSD) Menu" chapter (Service section) in this manual.

It is expected that the user has previous experience of the DDC/CI protocol and how to implement the commands in their own control applications. A suitable starting point for sending commands, are the GUI operated (or command line version) of softMCCS software, reference: <http://www.entechtaiwan.com/lib/softmccs.shtm>

The listed DDC/CI commands below are equivalent to the same functions available in the well implemented Hatteland Technology Serial/Ethernet Communication Control Interface (SCOM) protocol, where specified, reference: <https://www.hattelandtechnology.com/hubfs/pdfget/inb100018-6.htm>

The column "SCOM" is a reference and not part of the DDC/CI commands explained in the table below.

*NOTE: This chapter is an overall description of DDC/CI support for various/selected Hatteland Technology products. References to VGA (RGB), DVI and Composite may not be present on your product, due to hardware changes/Engineering Change Notifications issued for Multi Vision Displays (MVD), please check actual datasheet for your model to verify.
Reference: <https://www.hattelandtechnology.com/product-notifications/hardware-change-/upgrade-for-32inch-and-55inch-products>

Syntax: [S] = Start Condition & [P] = Stop Condition (marked with gray color). Numbers in black/green/red colors are Byte Value in Hexadecimal.

Description	Syntax and Functionality	Details and Values	Via SCOM
User Brightness Control (backlight) (0x10)	Set/Write Brightness value: [S] <6E:w> 51 84 03 10 00 xx FD [P] Reply of successful request: [S] <6F:r> FD 80 BE* [P] Read Brightness value: [S] <6E:w> 51 82 01 10 AC [P] Reply of successful request: [S] <6F:r> 6E 88 02 00 10 00 00 FF 00 xx 95* [P]	10 = Command ID Where xx = 0 to 255 Min-Max Range: 0-255 (0x00-0xFF) During Read reply, these values will be present. Read/Write support.	BRT
Power Mode (Power On/Off/Sleep) (0xD6) *Note: Not the same as OSD's "Power Plan" function.	Write Power Mode: [S] <6E:w> 51 84 03 D6 00 xx 5C [P] Reply of successful request: [S] <6F:r> 5C 80 BE* [P] Read Power Mode: [S] <6E:w> 51 82 01 D6 6A [P] Reply of successful request: [S] <6F:r> 6E 88 02 00 D6 01 00 05 00 xx 67* [P]	D6 = Command ID Where xx is: 0x01 = On 0x02 = Standby 0x03 = Standby 0x04 = Standby 0x05 = OFF 0x3F = Read Command: Modes are described in INB100018-6 (SCOM) document. Read/Write support.	PWR
Glass Display Control™ (GDC) Brilliance Button (0xE2)	Set/Write Brilliance value: [S] <6E:w> 51 84 03 E2 00 xx 68 [P] Reply of successful request: [S] <6F:r> 68 80 BE* [P] Read Brilliance value: [S] <6E:w> 51 82 01 E2 5E [P] Reply of successful request: [S] <6F:r> 6E 88 02 00 E2 00 00 FF 00 xx 00* [P]	E2 = Command ID Where xx = 0 to 255 Min-Max Range: 0-255 (0x00-0xFF) During Read reply, these values will be present. Read/Write support.	BRU

Operation Advanced (DDC/CI) Control Overview

Description	Syntax and Functionality	Details and Values	Via SCOM
Color Mode: Kelvin Color Temperature (0x14)	Set/Write Color Temperature: [S] <6E:w> 51 84 03 14 00 ww xx [P] Reply of successful request: [S] <6F:r> xx 80 BE* [P] Read Color Temperature Value: [S] <6E:w> 51 82 01 14 A8 [P] Reply of successful request: [S] <6F:r> 6E 88 02 00 14 00 00 0E 00 yy zz* [P]	14 = Command ID Where Write ww xx 05 A9 = 6500 07 AB = 8000 08 A4 = 9300 Where Read yy zz 05 AB = 6500 07 A9 = 8000 08 A6 = 9300 Read/Write support.	MCC: (Color Temperature Select)
Gamma Calibration (0x14)	Set/Write Calibration: [S] <6E:w> 51 84 03 14 00 ww xx [P] Reply of successful request: [S] <6F:r> xx 80 BE* [P] Read Calibration: [S] <6E:w> 51 82 01 14 A8 [P] Reply of successful request: [S] <6F:r> 6E 88 02 00 14 00 00 0E 00 yy zz* [P]	14 = Command ID Where Write ww xx 0C A0 = VGA* 0D A1 = DVI* 0E A2 = DP 0F A3 = HDMI Where Read yy zz 0C A2 = VGA* 0D A3 = DVI* 0E A4 = DP 0F A5 = HDMI Read/Write support.	MCC: (Gamma Calibration))
Buzzer Control (0xE5) Note: May not be available on all models, please review specific datasheet if "Buzzer" is available.	Write/Turn ON: [S] <6E:w> 51 84 03 E5 00 FF 5C [P] Reply of successful request: [S] <6F:r> 5C 80 BE* [P] Write/Turn OFF: [S] <6E:w> 51 84 03 E5 00 00 5D [P] Reply of successful Turn OFF request: [S] <6F:r> 5D 80 BE* [P]	E5 = Command ID Where FF = Turn On Where 00 = Turn Off Write Support only.	BZZ

Operation Advanced (DDC/CI) Control Overview

Description	Syntax and Functionality	Details and Values	Via SCOM
Touch Power Mode (0xE6)	Write/Set Power Mode: [S] <6E:w> 51 84 03 E6 00 xx A1 [P] Reply of successful request: [S] <6F:r> 5C 80 BE* [P] Read Power Mode: [S] <6E:w> 51 82 01 E6 5A [P] Reply of successful request : [S] <6F:r> 6E 88 02 00 E6 01 00 FF 00 FF 53* [P]	E6 = Command ID Where xx is: 0xFF = Always Active 0xFE = Only active when display is on and has an active input signal 0x00 = Only active if selected source is active AND Selected Source="DVI-I_1" 0x01 = Only active if selected source is active AND Selected Source="DVI-I_2" 0x02 = Only active if selected source is active AND Selected Source="DVI3" 0x03 = Only active if selected source is active AND Selected Source="DVI4" 0x10 = Only active if selected source is active AND Selected Source="RGB_1" 0x11 = Only active if selected source is active AND Selected Source="RGB_2" 0x12 = Only active if selected source is active AND Selected Source="RGB_3" 0x13 = Only active if selected source is active AND Selected Source="RGB_4" 0x20 = Only active if selected source is active AND Selected Source="CVIDEO1" 0x21 = Only active if selected source is active AND Selected Source="CVIDEO2" 0x22 = Only active if selected source is active AND Selected Source="CVIDEO3" 0x23 = Only active if selected source is active AND Selected Source="CVIDEO4" 0x30 = Only active if selected source is active AND Selected Source="DP1" 0x31 = Only active if selected source is active AND Selected Source="DP2" 0x32 = Only active if selected source is active AND Selected Source="DP3" 0x33 = Only active if selected source is active AND Selected Source="DP4" 0x3F = Read Command Read/Write support.	MCC: (Touch Power Mode)
Actual Temperature (0xF0)	Read Temperature: [S] <6E:w> 51 82 01 F0 4C [P] Reply of successful request: [S] <6F:r> 6E 88 02 00 F0 01 ww xx yy zz 63* [P]	F0 = Command ID Read support. Reply 4 bytes (ww, xx, yy, zz) indicating degree in Celsius. Example: 0038	TMP
Unit Run Time (0xF3)	Read Elapsed Hours: [S] <6E:w> 51 82 01 F3 4F [P] Reply of successful request: [S] <6F:r> 6E 88 02 00 F3 01 ww xx yy zz 63* [P]	F3 = Command ID Read support. Reply in ASCII 4 bytes (ww, xx, yy, zz) indicating hours. Example: 1038	ETC



Specifications

Specifications - HD 15T22 MMD-xxx-Fxxx

All specifications are subject to change without prior notice!

TFT Technology:

- High Quality TFT with LED Backlight Technology
- 15.0 inch viewable image size, Aspect Ratio 4:3
- TFT active-matrix liquid crystal panel

TFT Characteristics:

- Native Resolution : 1024 x 768
- Pixel Pitch (RGB) : 0.297 (H) x 0.297 (V) mm
- Response Time Standard : 35ms (typical), black to white
- Response Time High Bright : 19ms (typical), black to white
- Contrast Ratio Standard : 1500:1 (typical)
- Contrast Ratio High Bright : 800:1 (typical)
- Light Intensity Standard : 400 cd/m² (typical)
- Light Intensity High Bright : 800 cd/m² (typical)
- Viewable Angle Standard : +/- 85 deg. (Up/Down/Left/Right) (typical)
- Viewable Angle High Bright : +/- 80 deg. (D/L/R), +/- 60 deg. (U) (typ)
- Active Display Area : 304.1 (H) x 228.1 (V) mm
- Max Colors : 16.7 million

Supported Signals:

Resolutions:

- VGA : 640 x 480 (including 640 x 350)
- SVGA : 800 x 600 (including 720 x 400)
- XGA : 1024 x 768*

* Recommended for optimal picture quality

Video Signals:

- Interlaced HDTV, NTSC, PAL and SECAM video
- Composite video

Power Specifications:

Multi-power Supply:

- 100-240V AC - 50/60Hz + 24 VDC

Note: You may connect either AC power or DC power or both. In case both sources are connected, power will be sourced from the AC input. If AC input is lost, there will be a uninterrupted switch-over to DC input.

Power Consumption:

- Operating AC/DC: 22W (max)

Physical Considerations:

- W:356.00 [14.02"] x H:307.00 [12.09"] x D:71.50 [2.81"] mm [inch]
- Weight: Approx. 5kg / 11lbs

Signal Terminals:

- DVI-I IN : 2 x 29p DVI Female (or as VGA IN with adapter)*
- DP1.2 IN : 1 x 20p DisplayPort (female)
- Comp. Video IN : 2 x BNC Connector (female)
- SCOM RS-422/485 : 2 x 5-pin Terminal Block 3.81, non-isolated+Buzzer
- SCOM+Touch : 1 x USB TYPE A Connector (female)
- SCOM Ethernet : 1 x RJ45 Connector for Remote Control
- SCOM RS-232 : 1 x 9p D-SUB (female) non-isolated+Buzzer
- VGA OUT : 1 x 15p HD D-SUB (female) - Clone of VGA IN**
- Potmeter/User : 1 x 9p D-SUB (male)
(Potentiometer IN, +5VDC OUT, BRT +/- IN)
- AC Power IN : 1 x Std IEC Inlet
- DC Power IN : 1 x 2-pin Terminal Block 5.08

* DVI-I Port #1 as VGA IN also acts as clone to VGA Signal Out (buffered).

**Tested at recommended resolutions. The VGA output signal (buffered) is at same resolution and sync as the VGA input. The output is working even if the display unit is turned off, but power cable/supply must be connected/provided.

Note for DVI and VGA signal inputs:

DVI-I #1, DVI-D #1 and VGA #1 is Single Link.
DVI-I #2, DVI-D #2 and VGA #2 is Dual Link.

User Controls:

Behind front bezel - Glass Display Control™ (GDC) IP66:

- Power On/Off, On Screen Display Menu, Brightness Control (-/+)
- Hotkeys (left/right), Mode Status Indicators (Service)
- Buzzer (through glass), Light Sensor (behind glass)

Environmental Considerations:

- Operating : Temperature -15°C to +55°C
- Storage : Temperature -30°C to +70°C
- Humidity : Up to 95%
- IP Rating : Protection: IP66 front – IP22 rear (EN60529)
- Compass Safe Dist. : Standard: 100cm - Steering: 65cm

Lifetime Considerations:

Even though the test conditions for bridge units provide for a maximum operating temperature of 55°C, continuous operation of all electronic components should, if possible, take place at ambient temperatures of only 25°C. This is a necessary prerequisite for long life and low service costs.

Available Accessories:

- HD CMB SX2-A1 : 1 x Console Mount Kit. EN60945 Tested
 - HD TMB SX2-A1 : 1 x Table Mount Bracket. EN60945 Tested
 - HD VED SX2-A1 : 1 x VESA Adapter Kit (75/75, 100/100 & 200/100mm)
Not EN60945 Tested
 - JH 15TAP STD-C1 : 1 x Frame Adapter (15" Series 1 to Series X) retrofit
 - HD REM SX1-A1 : 1 x External Remote Control, EN60945 Tested
 - HD 15COV SX1-A1 : 1 x UV Sun Cover
 - P006997-1 : 1 x IP66 Mount Gasket (EPDM), for Flush/Console mount
- Please see user manual/datasheet for more information

Factory Options:

- Projected Capacitive Touch Screen (Multitouch, USB, Pen/Glove supported)
- Optical Bonding Technology
- Sunlight Readable / High Bright (includes Optical Bonding)
- 1 x Additional Composite Video IN (BNC) Connector

APPROVALS & CERTIFICATES

These products have been tested / type approved by the following classification societies:

IEC 60945 4th (EN 60945:2002)
CCS - China Classification Society

IACS E10

EU RO MR - Mutual Recognition

ClassNK - Nippon Kaiji Kyokai

Specifications - HD 15T22 MMD-xxx-FHxx

All specifications are subject to change without prior notice!

TFT Technology:

- High Quality TFT with LED Backlight Technology
- Sunlight Readable / High Bright (includes Optical Bonding Technology)
- 15.0 inch viewable image size, Aspect Ratio 4:3
- TFT active-matrix liquid crystal panel

TFT Characteristics:

- Native Resolution : 1024 x 768
- Pixel Pitch (RGB) : 0.297 (H) x 0.297 (V) mm
- Response Time : 19ms (typical), black to white
- Contrast Ratio : 800:1 (typical)
- Light Intensity : 800 cd/m² (typical)
- Viewable Angle : +/- 80° (6, 9 & 3 o'clock)
+/- 60° (12 o'clock) (typ)
- Active Display Area : 304.1 (H) x 228.1 (V) mm
- Max Colors : 16.7 million

Supported Signals:

Resolutions:

- VGA : 640 x 480 (including 640 x 350)
- SVGA : 800 x 600 (including 720 x 400)
- XGA : 1024 x 768*

* Recommended for optimal picture quality

Video Signals:

- Interlaced HDTV, NTSC, PAL and SECAM video
- Composite video

Power Specifications:

Multi-power Supply:

- 100-240V AC - 50/60Hz + 24 VDC

Note: You may connect either AC power or DC power or both. In case both sources are connected, power will be sourced from the AC input. If AC input is lost, there will be a uninterrupted switch-over to DC input.

Power Consumption:

- Operating AC/DC: 33W (max)

Physical Considerations:

- W:356.00 [14.02"] x H:307.00 [12.09"] x D:78.50 [3.09"] mm [inch]
- Weight: Approx. 5.6kg / 12.3lbs
- Delivery includes an EPDM sealing gasket for IP66 console mount.

Signal Terminals:

- DVI-I IN : 2 x 29p DVI Female (or as VGA IN with adapter)*
- DP1.2 IN : 1 x 20p DisplayPort (female)
- Comp. Video IN : 2 x BNC Connector (female)
- SCOM RS-422/485 : 2 x 5-pin Terminal Block 3.81, non-isolated+Buzzer
- SCOM+Touch : 1 x USB TYPE A Connector (female)
- SCOM Ethernet : 1 x RJ45 Connector for Remote Control
- SCOM RS-232 : 1 x 9p D-SUB (female) non-isolated+Buzzer
- VGA OUT : 1 x 15p HD D-SUB (female) - Clone of VGA IN**
- Potmeter/User : 1 x 9p D-SUB (male)
(Potentiometer IN, +5VDC OUT, BRT +/- IN)
- AC Power IN : 1 x Std IEC Inlet
- DC Power IN : 1 x 2-pin Terminal Block 5.08

* DVI-I Port #1 as VGA IN also acts as clone to VGA Signal Out (buffered).

**Tested at recommended resolutions. The VGA output signal (buffered) is at same resolution and sync as the VGA input. The output is working even if the display unit is turned off, but power cable/supply must be connected/provided.

Note for DVI and VGA signal inputs:

DVI-I #1, DVI-D #1 and VGA #1 is Single Link.
DVI-I #2, DVI-D #2 and VGA #2 is Dual Link.

User Controls:

Behind front bezel - Glass Display Control™ (GDC) IP66:

- Power On/Off, On Screen Display Menu, Brightness Control (-/+)
- Hotkeys (left/right), Mode Status Indicators (Service)
- Buzzer (through glass), Light Sensor (behind glass)

Environmental Considerations:

- Operating : Temperature -15°C to +55°C
- Storage : Temperature -30°C to +70°C
- Humidity : Up to 95%
- IP Rating : Protection: IP66 front – IP22 rear (EN60529)
- Compass Safe Dist. : Standard: 100cm - Steering: 65cm

Lifetime Considerations:

Even though the test conditions for bridge units provide for a maximum operating temperature of 55°C, continuous operation of all electronic components should, if possible, take place at ambient temperatures of only 25°C. This is a necessary prerequisite for long life and low service costs.

Available Accessories:

- HD CMB SX2-A1 : 1 x Console Mount Kit. EN60945 Tested
 - HD TMB SX2-A1 : 1 x Table Mount Bracket. EN60945 Tested
 - HD VED SX2-A1 : 1 x VESA Adapter Kit (75/75, 100/100 & 200/100mm)
Not EN60945 Tested
 - JH 15TAP STD-C1 : 1 x Frame Adapter (15" Series 1 to Series X) retrofit
 - HD REM SX1-A1 : 1 x External Remote Control, EN60945 Tested
 - HD 15COV SX1-A1 : 1 x UV Sun Cover
 - P006997-1 : 1 x IP66 Mount Gasket (EPDM), for Flush/Console mount
- Please see user manual/datasheet for more information

Factory Options:

- Projected Capacitive Touch Screen (Multitouch, USB, Pen/Glove supported)
- 1 x Additional Composite Video IN (BNC) Connector

APPROVALS & CERTIFICATES

These products have been tested / type approved by the following classification societies:

IEC 60945 4th (EN 60945:2002)

IACS E10

EU RO MR - Mutual Recognition

ClassNK - Nippon Kaiji Kyokai

CCS - China Classification Society

Specifications - HD 17T22 MMD-xxx-Fxxx

All specifications are subject to change without prior notice!

TFT Technology:

- High Quality TFT with LED Backlight Technology
- 17.0 inch viewable image size, Aspect Ratio 5:4
- TFT active-matrix liquid crystal panel

TFT Characteristics:

- Native Resolution : 1280 x 1024
- Pixel Pitch (RGB) : 0.264 (H) x 0.264 (V) mm
- Response Time Standard : 5ms (typical), "black" to "white"
- Response Time High Bright: 30ms (typical), "black" to "white"
- Contrast Ratio Standard : 1000:1 (typical)
- Contrast Ratio High Bright : 800:1 (typical)
- Light Intensity Standard : 350 cd/m² (typical)
- Light Intensity High Bright : 1000 cd/m² (typical)
- Viewable Angle Standard : +/- 85° (Down/Left/Right), 60° (Up) (typ)
- Active Display Area : 337.92 (H) x 270.336 (V) mm
- Max Colors : 16.7 million

Supported Signals:

Resolutions:

- VGA : 640 x 480 (including 640 x 350)
- SVGA : 800 x 600 (including 720 x 400)
- XGA : 1024 x 768
- SXGA : 1280 x 1024*

* Recommended for optimal picture quality

Video Signals:

- Interlaced HDTV, NTSC, PAL and SECAM video
- Composite video

Power Specifications:

Multi-power Supply:

- 100-240V AC - 50/60Hz + 24 VDC

Note: You may connect either AC power or DC power or both. In case both sources are connected, power will be sourced from the AC input. If AC input is lost, there will be a uninterrupted switch-over to DC input.

Power Consumption:

- Operating AC/DC: 34W (max)

Physical Considerations:

- W:390.00 [15.35"] x H:351.00 [13.82"] x D:71.50 [2.81"] mm [inch]
- Weight: Approx. 6.5kg / 14.3lbs

Signal Terminals:

- DVI-I IN : 2 x 29p DVI Female (or as VGA IN with adapter)*
- DP1.2 IN : 1 x 20p DisplayPort (female)
- Comp. Video IN : 2 x BNC Connector (female)
- SCOM RS-422/485 : 2 x 5-pin Terminal Block 3.81, non-isolated+Buzzer
- SCOM+Touch : 1 x USB TYPE A Connector (female)
- SCOM Ethernet : 1 x RJ45 Connector for Remote Control
- SCOM RS-232 : 1 x 9p D-SUB (female) non-isolated+Buzzer
- VGA OUT : 1 x 15p HD D-SUB (female) - Clone of VGA IN**
- Potmeter/User : 1 x 9p D-SUB (male)
(Potentiometer IN, +5VDC OUT, BRT +/- IN)
- AC Power IN : 1 x Std IEC Inlet
- DC Power IN : 1 x 2-pin Terminal Block 5.08

* DVI-I Port #1 as VGA IN also acts as clone to VGA Signal Out (buffered).

**Tested at recommended resolutions. The VGA output signal (buffered) is at same resolution and sync as the VGA input. The output is working even if the display unit is turned off, but power cable/supply must be connected/provided.

Note for DVI and VGA signal inputs:

DVI-I #1, DVI-D #1 and VGA #1 is Single Link.

DVI-I #2, DVI-D #2 and VGA #2 is Dual Link.

User Controls:

Behind front bezel - Glass Display Control™ (GDC) IP66:

- Power On/Off, On Screen Display Menu, Brightness Control (-/+)
- Hotkeys (left/right), Mode Status Indicators (ECDIS, Service)
- Buzzer (through glass), Light Sensor (behind glass)

Environmental Considerations:

- Operating : Temperature -15°C to +55°C
- Storage : Temperature -30°C to +70°C
- Humidity : Up to 95%
- IP Rating : Protection: IP66 front – IP22 rear (EN60529)
- Compass Safe Dist. : Standard: 125cm - Steering: 85cm

Lifetime Considerations:

Even though the test conditions for bridge units provide for a maximum operating temperature of 55°C, continuous operation of all electronic components should, if possible, take place at ambient temperatures of only 25°C. This is a necessary prerequisite for long life and low service costs.

Available Accessories:

- HD CMB SX2-A1 : 1 x Console Mount Kit. EN60945 Tested
 - HD TMB SX2-A1 : 1 x Table Mount Bracket. EN60945 Tested
 - HD VED SX2-B1 : 1 x VESA Adapter Kit (75/75, 100/100 & 200/100mm)
Not EN60945 Tested
 - HD REM SX1-A1 : 1 x External Remote Control, EN60945 Tested
 - HD 17COV SX1-A1 : 1 x UV Sun Cover
 - P007130-1 : 1 x IP66 Mount Gasket (EPDM), for Flush/Console mount
- Please see user manual/datasheet for more information

Factory Options:

- Projected Capacitive Touch Screen (Multitouch, USB, Pen/Glove supported)
- Optical Bonding Technology
- Color Calibrated models (ECDIS)
- Sunlight Readable / High Bright (includes Optical Bonding)
- 1 x Additional Composite Video IN (BNC) Connector

APPROVALS & CERTIFICATES

These products have been tested / type approved by the following classification societies:

IEC 60945 4th (EN 60945:2002)
CCS - China Classification Society

IACS E10

EU RO MR - Mutual Recognition

ClassNK - Nippon Kaiji Kyokai

Specifications - HD 17T22 MMD-xxx-FHxx

All specifications are subject to change without prior notice!

TFT Technology:

- High Quality TFT with LED Backlight Technology
- Sunlight Readable / High Bright (includes Optical Bonding Technology)
- 17.0 inch viewable image size, Aspect Ratio 5:4
- TFT active-matrix liquid crystal panel

TFT Characteristics:

- Native Resolution : 1280 x 1024
- Pixel Pitch (RGB) : 0.264 (H) x 0.264 (V) mm
- Response Time : 30ms (typical), "black" to "white"
- Contrast Ratio : 800:1 (typical)
- Light Intensity : 1000 cd/m² (typical)
- Viewable Angle @ CR>10 : +/- 85° (6, 9 & 3 o'clock)
+/- 60° (12 o'clock) (typ)
- Active Display Area : 337.92 (H) x 270.336 (V) mm
- Max Colors : 16.7 million

Supported Signals:

Resolutions:

- VGA : 640 x 480 (including 640 x 350)
- SVGA : 800 x 600 (including 720 x 400)
- XGA : 1024 x 768
- SXGA : 1280 x 1024*

* Recommended for optimal picture quality

Video Signals:

- Interlaced HDTV, NTSC, PAL and SECAM video
- Composite video

Power Specifications:

Multi-power Supply:

- 100-240V AC - 50/60Hz + 24 VDC

Note: You may connect either AC power or DC power or both. In case both sources are connected, power will be sourced from the AC input. If AC input is lost, there will be a uninterrupted switch-over to DC input.

Power Consumption:

- Operating AC/DC: 44W (max)

Physical Considerations:

- W:390.00 [15.35"] x H:351.00 [13.82"] x D:78.50 [3.09"] mm [inch]
- Weight: Approx. 6.8kg / 15.0lbs
- Delivery includes an EPDM sealing gasket for IP66 console mount.

Signal Terminals:

- DVI-I IN : 2 x 29p DVI Female (or as VGA IN with adapter)*
- DP1.2 IN : 1 x 20p DisplayPort (female)
- Comp. Video IN : 2 x BNC Connector (female)
- SCOM RS-422/485 : 2 x 5-pin Terminal Block 3.81, non-isolated+Buzzer
- SCOM+Touch : 1 x USB TYPE A Connector (female)
- SCOM Ethernet : 1 x RJ45 Connector for Remote Control
- SCOM RS-232 : 1 x 9p D-SUB (female) non-isolated+Buzzer
- VGA OUT : 1 x 15p HD D-SUB (female) - Clone of VGA IN**
- Potmeter/User : 1 x 9p D-SUB (male)
(Potentiometer IN, +5VDC OUT, BRT +/- IN)
- AC Power IN : 1 x Std IEC Inlet
- DC Power IN : 1 x 2-pin Terminal Block 5.08

* DVI-I Port #1 as VGA IN also acts as clone to VGA Signal Out (buffered).

**Tested at recommended resolutions. The VGA output signal (buffered) is at same resolution and sync as the VGA input. The output is working even if the display unit is turned off, but power cable/supply must be connected/provided.

Note for DVI and VGA signal inputs:

DVI-I #1, DVI-D #1 and VGA #1 is Single Link.
DVI-I #2, DVI-D #2 and VGA #2 is Dual Link.

User Controls:

Behind front bezel - Glass Display Control™ (GDC) IP66:

- Power On/Off, On Screen Display Menu, Brightness Control (-/+)
- Hotkeys (left/right), Mode Status Indicators (ECDIS, Service)
- Buzzer (through glass), Light Sensor (behind glass)

Environmental Considerations:

- Operating : Temperature -15°C to +55°C
- Storage : Temperature -30°C to +70°C
- Humidity : Up to 95%
- IP Rating : Protection: IP66 front – IP22 rear (EN60529)
- Compass Safe Dist. : Standard: 100cm - Steering: 70cm

Lifetime Considerations:

Even though the test conditions for bridge units provide for a maximum operating temperature of 55°C, continuous operation of all electronic components should, if possible, take place at ambient temperatures of only 25°C. This is a necessary prerequisite for long life and low service costs.

Available Accessories:

- HD CMB SX2-A1 : 1 x Console Mount Kit. EN60945 Tested
 - HD TMB SX2-A1 : 1 x Table Mount Bracket. EN60945 Tested
 - HD VED SX2-B1 : 1 x VESA Adapter Kit (75/75, 100/100 & 200/100mm)
Not EN60945 Tested
 - HD REM SX1-A1 : 1 x External Remote Control, EN60945 Tested
 - HD 17COV SX1-A1 : 1 x UV Sun Cover
 - P007130-1 : 1 x IP66 Mount Gasket (EPDM), for Flush/Console mount
- Please see user manual/datasheet for more information

Factory Options:

- Projected Capacitive Touch Screen (Multitouch, USB, Pen/Glove supported)
- Color Calibrated models (ECDIS)
- 1 x Additional Composite Video IN (BNC) Connector

APPROVALS & CERTIFICATES

These products have been tested / type approved by the following classification societies:

IEC 60945 4th (EN 60945:2002)

IACS E10

EU RO MR - Mutual Recognition

ClassNK - Nippon Kaiji Kyokai

CCS - China Classification Society

Specifications - HD 19T22 MMD-xxx-Fxxx

All specifications are subject to change without prior notice!

TFT Technology:

- High Quality TFT with LED Backlight Technology
- 19.0 inch viewable image size, Aspect Ratio 5:4
- TFT active-matrix liquid crystal panel
- MVA (Multi-domain Vertical Alignment) LCD Technology

TFT Characteristics:

- Native Resolution : 1280 x 1024
- Pixel Pitch (RGB) : 0.294 (H) x 0.294 (V) mm
- Response Time : 35ms (typical), "black" to "white"
- Contrast Ratio Standard : 1500:1 (typical)
- Contrast Ratio High Bright : 2000:1 (typical)
- Light Intensity Standard : 350 cd/m² (typical)
- Light Intensity High Bright : 1000 cd/m² (typical)
- Viewable Angle Standard : +/- 85 deg. (typical) (Up/Down/Left/Right)
- Viewable Angle High Bright : +/- 89 deg. (typical) (Up/Down/Left/Right)
- Active Display Area : 376.32 (H) x 301.056 (V) mm
- Max Colors : 16.7 million

Supported Signals:

Resolutions:

- VGA : 640 x 480 (including 640 x 350)
- SVGA : 800 x 600 (including 720 x 400)
- XGA : 1024 x 768
- SXGA : 1280 x 1024*

* Recommended for optimum picture quality

Video Signals:

- Interlaced HDTV, NTSC, PAL and SECAM video
- Composite video

Power Specifications:

Multi-power Supply:

- 100-240V AC - 50/60Hz + 24 VDC

Note: You may connect either AC power or DC power or both. In case both sources are connected, power will be sourced from the AC input. If AC input is lost, there will be a uninterrupted switch-over to DC input.

Power Consumption:

- Operating AC/DC: 32W (max)

Physical Considerations:

- W:429.00 [16.89"] x H:382.00 [15.04"] x D:71.50 [2.81"] mm [inch]
- Weight: Approx. 8.1kg / 17.8lbs

Signal Terminals:

- DVI-I IN : 2 x 29p DVI Female (or as VGA IN with adapter)*
- DP1.2 IN : 1 x 20p DisplayPort (female)
- Comp. Video IN : 2 x BNC Connector (female)
- SCOM RS-422/485 : 2 x 5-pin Terminal Block 3.81, non-isolated+Buzzer
- SCOM+Touch : 1 x USB TYPE A Connector (female)
- SCOM Ethernet : 1 x RJ45 Connector for Remote Control
- SCOM RS-232 : 1 x 9p D-SUB (female) non-isolated+Buzzer
- VGA OUT : 1 x 15p HD D-SUB (female) - Clone of VGA IN**
- Potmeter/User : 1 x 9p D-SUB (male)
(Potentiometer IN, +5VDC OUT, BRT +/- IN)
- AC Power IN : 1 x Std IEC Inlet
- DC Power IN : 1 x 2-pin Terminal Block 5.08

* DVI-I Port #1 as VGA IN also acts as clone to VGA Signal Out (buffered).

**Tested at recommended resolutions. The VGA output signal (buffered) is at same resolution and sync as the VGA input. The output is working even if the display unit is turned off, but power cable/supply must be connected/provided.

Note for DVI and VGA signal inputs:

DVI-I #1, DVI-D #1 and VGA #1 is Single Link.
DVI-I #2, DVI-D #2 and VGA #2 is Dual Link.

User Controls:

Behind front bezel - Glass Display Control™ (GDC) IP66:

- Power On/Off, On Screen Display Menu, Brightness Control (-/+)
- Hotkeys (left/right), Mode Status Indicators (ECDIS, Service)
- Buzzer (through glass), Light Sensor (behind glass)

Environmental Considerations:

- Operating : Temperature -15°C to +55°C
- Storage : Temperature -30°C to +70°C
- Humidity : Up to 95%
- IP Rating : Protection: IP66 front – IP22 rear (EN60529)
- Compass Safe Dist. : Standard: 90cm - Steering: 45cm

Lifetime Considerations:

Even though the test conditions for bridge units provide for a maximum operating temperature of 55°C, continuous operation of all electronic components should, if possible, take place at ambient temperatures of only 25°C. This is a necessary prerequisite for long life and low service costs.

Available Accessories:

- HD CMB SX2-A1 : 1 x Console Mount Kit. EN60945 Tested
 - HD TMB SX2-A1 : 1 x Table Mount Bracket. EN60945 Tested
 - HD VED SX2-C1 : 1 x VESA Adapter Kit (75/75, 100/100 & 200/100mm)
Not EN60945 Tested
 - JH 19TAP STD-C1 : 1 x Frame Adapter (19" Series 1 to Series X) retrofit
 - HD 19TAP SX2-C2 : 1 x Frame Adapter (19" Series X to Series 2) retrofit
 - HD REM SX1-A1 : 1 x External Remote Control, EN60945 Tested
 - HD 19COV SX1-A1 : 1 x UV Sun Cover
 - P007131-1 : 1 x IP66 Mount Gasket (EPDM), for Flush/Console mount
- Please see user manual/datasheet for more information

Factory Options:

- Projected Capacitive Touch Screen (Multitouch, USB, Pen/Glove supported)
- Optical Bonding Technology
- Color Calibrated models (ECDIS)
- Sunlight Readable / High Bright (includes Optical Bonding)
- 1 x Additional Composite Video IN (BNC) Connector

APPROVALS & CERTIFICATES

These products have been tested / type approved by the following classification societies:

IEC 60945 4th (EN 60945:2002)
CCS - China Classification Society

IACS E10

EU RO MR - Mutual Recognition

ClassNK - Nippon Kaiji Kyokai

Specifications - HD 19T22 MMD-xxx-FHxx

All specifications are subject to change without prior notice!

TFT Technology:

- High Quality TFT with LED Backlight Technology
- Sunlight Readable / High Bright (includes Optical Bonding Technology)
- 19.0 inch viewable image size, Aspect Ratio 5:4
- TFT active-matrix liquid crystal panel
- MVA (Multi-domain Vertical Alignment) LCD Technology

TFT Characteristics:

- Native Resolution : 1280 x 1024
- Pixel Pitch (RGB) : 0.294 (H) x 0.294 (V) mm
- Response Time : 35ms (typical), "black" to "white"
- Contrast Ratio : 2000:1 (typical)
- Light Intensity : 1000 cd/m² (typical)
- Viewable Angle : +/- 89 deg. (typical) (Up/Down/Left/Right)
- Active Display Area : 376.32 (H) x 301.056 (V) mm
- Max Colors : 16.7 million

Supported Signals:

Resolutions:

- VGA : 640 x 480 (including 640 x 350)
- SVGA : 800 x 600 (including 720 x 400)
- XGA : 1024 x 768
- SXGA : 1280 x 1024*

* Recommended for optimum picture quality

Video Signals:

- Interlaced HDTV, NTSC, PAL and SECAM video
- Composite video

Power Specifications:

Multi-power Supply:

- 100-240V AC - 50/60Hz + 24 VDC

Note: You may connect either AC power or DC power or both. In case both sources are connected, power will be sourced from the AC input. If AC input is lost, there will be a uninterrupted switch-over to DC input.

Power Consumption:

- Operating AC/DC: 57W (max)

Physical Considerations:

- W:429.00 [16.89"] x H:382.00 [15.04"] x D:78.50 [3.09"] mm [inch]
- Weight: Approx. 8.1kg / 17.8lbs
- Delivery includes an EPDM sealing gasket for IP66 console mount.

Signal Terminals:

- DVI-I IN : 2 x 29p DVI Female (or as VGA IN with adapter)*
- DP1.2 IN : 1 x 20p DisplayPort (female)
- Comp. Video IN : 2 x BNC Connector (female)
- SCOM RS-422/485 : 2 x 5-pin Terminal Block 3.81, non-isolated+Buzzer
- SCOM+Touch : 1 x USB TYPE A Connector (female)
- SCOM Ethernet : 1 x RJ45 Connector for Remote Control
- SCOM RS-232 : 1 x 9p D-SUB (female) non-isolated+Buzzer
- VGA OUT : 1 x 15p HD D-SUB (female) - Clone of VGA IN**
- Potmeter/User : 1 x 9p D-SUB (male)
(Potentiometer IN, +5VDC OUT, BRT +/- IN)
- AC Power IN : 1 x Std IEC Inlet
- DC Power IN : 1 x 2-pin Terminal Block 5.08

* DVI-I Port #1 as VGA IN also acts as clone to VGA Signal Out (buffered).

**Tested at recommended resolutions. The VGA output signal (buffered) is at same resolution and sync as the VGA input. The output is working even if the display unit is turned off, but power cable/supply must be connected/provided.

Note for DVI and VGA signal inputs:

DVI-I #1, DVI-D #1 and VGA #1 is Single Link.
DVI-I #2, DVI-D #2 and VGA #2 is Dual Link.

User Controls:

Behind front bezel - Glass Display Control™ (GDC) IP66:

- Power On/Off, On Screen Display Menu, Brightness Control (-/+)
- Hotkeys (left/right), Mode Status Indicators (ECDIS, Service)
- Buzzer (through glass), Light Sensor (behind glass)

Environmental Considerations:

- Operating : Temperature -15°C to +55°C
- Storage : Temperature -30°C to +70°C
- Humidity : Up to 95%
- IP Rating : Protection: IP66 front – IP22 rear (EN60529)
- Compass Safe Dist. : Standard: 90cm - Steering: 45cm

Lifetime Considerations:

Even though the test conditions for bridge units provide for a maximum operating temperature of 55°C, continuous operation of all electronic components should, if possible, take place at ambient temperatures of only 25°C. This is a necessary prerequisite for long life and low service costs.

Available Accessories:

- HD CMB SX2-A1 : 1 x Console Mount Kit. EN60945 Tested
 - HD TMB SX2-A1 : 1 x Table Mount Bracket. EN60945 Tested
 - HD VED SX2-C1 : 1 x VESA Adapter Kit (75/75, 100/100 & 200/100mm)
Not EN60945 Tested
 - JH 19TAP STD-C1 : 1 x Frame Adapter (19" Series 1 to Series X) retrofit
 - HD 19TAP SX2-C2 : 1 x Frame Adapter (19" Series X to Series 2) retrofit
 - HD REM SX1-A1 : 1 x External Remote Control, EN60945 Tested
 - HD 19COV SX1-A1 : 1 x UV Sun Cover
 - P007131-1 : 1 x IP66 Mount Gasket (EPDM), for Flush/Console mount
- Please see user manual/datasheet for more information

Factory Options:

- Projected Capacitive Touch Screen (Multitouch, USB, Pen/Glove supported)
- Color Calibrated models (ECDIS)
- 1 x Additional Composite Video IN (BNC) Connector

APPROVALS & CERTIFICATES

These products have been tested / type approved by the following classification societies:

IEC 60945 4th (EN 60945:2002)
CCS - China Classification Society

IACS E10

EU RO MR - Mutual Recognition

ClassNK - Nippon Kaiji Kyokai

Specifications - HD 24T22 MMD-xxx-Fxxx

All specifications are subject to change without prior notice!

TFT Technology:

- LED Backlight Technology, TFT Active-matrix
- 24.0 inch viewable image size, Widescreen, Aspect Ratio 16:9
- MVA (Multi-domain Vertical Alignment) LCD Technology, RGB vertical stripe

TFT Characteristics:

- Native Resolution : 1920 x 1080 (FHD)
- Pixel Pitch (RGB) : 0.27675 (H) x 0.27675 (V) mm
- Response Time : 25 ms (typical), "black" to "white"
- Contrast Ratio Standard : 3000:1 (typical)
- Contrast Ratio High Bright : 2300:1 (typical)
- Light Intensity Standard : 300 cd/m² (typical)
- Light Intensity High Bright : 1000 cd/m² (typical)
- Viewable Angle : +/- 89 deg. (typical) (Up/Down/Left/Right)
- Active Display Area : 531.36 (H) x 298.89 (V) mm
- Max Colors : 16.7 millions (RGB 8-bit)

Supported Signals:

Resolutions:

- VGA : 640 x 480 (including 640 x 350)
- SVGA : 800 x 600 (including 720 x 400)
- XGA : 1024 x 768
- SXGA : 1280 x 1024
- UXGA : 1600 x 1200
- FHD : 1920 x 1080*

* Recommended for optimal picture quality

Video Signals:

- Interlaced HDTV, NTSC, PAL and SECAM video
- Composite video

Power Specifications:

Multi-power Supply:

- 100-240V AC - 50/60Hz + 24 VDC

Note: You may connect either AC power or DC power or both. In case both sources are connected, power will be sourced from the AC input. If AC input is lost, there will be a uninterrupted switch-over to DC input.

Power Consumption:

- Operating AC/DC: 51W (max)

Physical Considerations:

- W:593.00 [23.35"] x H:384.00 [15.12"] x D:70.00 [2.76"] mm [inch]
- Weight: 9.1kg / 20.0lbs

Signal Terminals:

- DVI-I IN : 2 x 29p DVI Female (or as VGA IN with adapter)*
- DP1.2 IN : 1 x 20p DisplayPort (female)
- Comp. Video IN : 2 x BNC Connector (female)
- SCOM RS-422/485 : 2 x 5-pin Terminal Block 3.81, non-isolated+Buzzer
- SCOM+Touch : 1 x USB TYPE A Connector (female)
- SCOM Ethernet : 1 x RJ45 Connector for Remote Control
- SCOM RS-232 : 1 x 9p D-SUB (female) non-isolated+Buzzer
- VGA OUT : 1 x 15p HD D-SUB (female) - Clone of VGA IN**
- Potmeter/User : 1 x 9p D-SUB (male)
(Potentiometer IN, +5VDC OUT, BRT +/- IN)
- AC Power IN : 1 x Std IEC Inlet
- DC Power IN : 1 x 2-pin Terminal Block 5.08

* DVI-I Port #1 as VGA IN also acts as clone to VGA Signal Out (buffered).

**Tested at recommended resolutions. The VGA output signal (buffered) is at same resolution and sync as the VGA input. The output is working even if the display unit is turned off, but power cable/supply must be connected/provided.

Note for DVI and VGA signal inputs:

DVI-I #1, DVI-D #1 and VGA #1 is Single Link.

DVI-I #2, DVI-D #2 and VGA #2 is Dual Link.

User Controls:

Behind front bezel - Glass Display Control™ (GDC) IP66:

- Power On/Off, On Screen Display Menu, Brightness Control (-/+)
- Hotkeys (left/right), Mode Status Indicators (ECDIS, Service)
- Buzzer (through glass), Light Sensor (behind glass)

Environmental Considerations:

- Operating : Temperature -15°C to +55°C
- Storage : Temperature -30°C to +70°C
- Humidity : Up to 95%
- IP Rating : Protection: IP66 front - IP22 rear (EN60529)
- Compass Safe Dist. : Standard: 140cm - Steering: 85cm

Lifetime Considerations:

Even though the test conditions for bridge units provide for a maximum operating temperature of 55°C, continuous operation of all electronic components should, if possible, take place at ambient temperatures of only 25°C. This is a necessary prerequisite for long life and low service costs.

Available Accessories:

- HD CMB SX2-E1 : 1 x Console Mount Kit. EN60945 Tested
 - HD TMB SX1-C1 : 1 x Table Mount Bracket. EN60945 Tested
 - HD VED SX2-I1 : 1 x VESA Adapter Kit (100/100 & 200/100mm)
Not EN60945 Tested
 - HD REM SX1-A1 : 1 x External Remote Control, EN60945 Tested
 - HD 24COV SX1-A1 : 1 x UV Sun Cover
 - P022211 : 1 x IP66 Mount Gasket (EPDM), for Flush/Console mount
 - HD CAK SX2-A1 : 1 x Front Console Mounting/Adapter Kit
- Please see user manual/datasheet for more information

Factory Options:

- Projected Capacitive Touch Screen (Multitouch, USB, Pen/Glove supported)
- Optical Bonding Technology
- Color Calibrated models (ECDIS)
- Sunlight Readable / High Bright (includes Optical Bonding)
- 1 x Additional Composite Video IN (BNC) Connector

APPROVALS & CERTIFICATES

These products have been tested / type approved by the following classification societies:

IEC 60945 4th (EN 60945:2002)
CCS - China Classification Society

IACS E10

EU RO MR - Mutual Recognition

ClassNK - Nippon Kaiji Kyokai

Specifications - HD 24T22 MMD-xxx-FHxx

All specifications are subject to change without prior notice!

TFT Technology:

- LED Backlight Technology, TFT Active-matrix
- Sunlight Readable / High Bright (includes Optical Bonding Technology)
- 24.0 inch viewable image size, Widescreen, Aspect Ratio 16:9
- MVA (Multi-domain Vertical Alignment) LCD Technology, RGB vertical stripe

TFT Characteristics:

- Native Resolution : 1920 x 1080 (FHD)
- Pixel Pitch (RGB) : 0.27675 (H) x 0.27675 (V) mm
- Response Time : 25 ms (typical), "black" to "white"
- Contrast Ratio : 2300:1 (typical)
- Light Intensity : 1000 cd/m² (typical)
- Viewable Angle : +/- 89 deg. (typical) (Up/Down/Left/Right)
- Active Display Area : 531.36 (H) x 298.89 (V) mm
- Max Colors : 16.7 million

Supported Signals:

Resolutions:

- VGA : 640 x 480 (including 640 x 350)
- SVGA : 800 x 600 (including 720 x 400)
- XGA : 1024 x 768
- SXGA : 1280 x 1024
- UXGA : 1600 x 1200
- FHD : 1920 x 1080*

* Recommended for optimal picture quality

Video Signals:

- Interlaced HDTV, NTSC, PAL and SECAM video
- Composite video

Power Specifications:

Multi-power Supply:

- 100-240V AC - 50/60Hz + 24 VDC

Note: You may connect either AC power or DC power or both. In case both sources are connected, power will be sourced from the AC input. If AC input is lost, there will be a uninterrupted switch-over to DC input.

Power Consumption:

- Operating AC/DC: 68W (max)*

*Specified as delivered from factory. All additional loads for installed / connected equipment have to be added to power consumption and multiplied by 1.6 to compensate for efficiency in power converters.

Physical Considerations:

- W:593.00 [23.35"] x H:384.00 [15.12"] x D:77.00 [3.03"] mm [inch]
- Weight: 9.4kg / 20.7lbs
- Delivery includes an EPDM sealing gasket for IP66 console mount.

Signal Terminals:

- DVI-I IN : 2 x 29p DVI Female (or as VGA IN with adapter)*
- DP1.2 IN : 1 x 20p DisplayPort (female)
- Comp. Video IN : 2 x BNC Connector (female)
- SCOM RS-422/485 : 2 x 5-pin Terminal Block 3.81, non-isolated+Buzzer
- SCOM+Touch : 1 x USB TYPE A Connector (female)
- SCOM Ethernet : 1 x RJ45 Connector for Remote Control
- SCOM RS-232 : 1 x 9p D-SUB (female) non-isolated+Buzzer
- VGA OUT : 1 x 15p HD D-SUB (female) - Clone of VGA IN**
- Potmeter/User : 1 x 9p D-SUB (male)
(Potentiometer IN, +5VDC OUT, BRT +/- IN)
- AC Power IN : 1 x Std IEC Inlet
- DC Power IN : 1 x 2-pin Terminal Block 5.08

* DVI-I Port #1 as VGA IN also acts as clone to VGA Signal Out (buffered).

**Tested at recommended resolutions. The VGA output signal (buffered) is at same resolution and sync as the VGA input. The output is working even if the display unit is turned off, but power cable/supply must be connected/provided.

Note for DVI and VGA signal inputs:

DVI-I #1, DVI-D #1 and VGA #1 is Single Link.
DVI-I #2, DVI-D #2 and VGA #2 is Dual Link.

User Controls:

Behind front bezel - Glass Display Control™ (GDC) IP66:

- Power On/Off, On Screen Display Menu, Brightness Control (-/+)
- Hotkeys (left/right), Mode Status Indicators (ECDIS, Service)
- Buzzer (through glass), Light Sensor (behind glass)

Environmental Considerations:

- Operating : Temperature -15°C to +55°C
- Storage : Temperature -30°C to +70°C
- Humidity : Up to 95%
- IP Rating : Protection: IP66 front – IP22 rear (EN60529)
- Compass Safe Dist. : Standard: 140cm - Steering: 85cm

Lifetime Considerations:

Even though the test conditions for bridge units provide for a maximum operating temperature of 55°C, continuous operation of all electronic components should, if possible, take place at ambient temperatures of only 25°C. This is a necessary prerequisite for long life and low service costs.

Available Accessories:

- HD CMB SX2-E1 : 1 x Console Mount Kit. EN60945 Tested
- HD TMB SX1-C1 : 1 x Table Mount Bracket. EN60945 Tested
- HD VED SX2-I1 : 1 x VESA Adapter (100/100 & 200/100mm)
Not EN60945 Tested
- HD REM SX1-A1 : 1 x External Remote Control, EN60945 Tested
- HD 24COV SX1-A1 : 1 x UV Sun Cover
- P022211 : 1 x IP66 Mount Gasket (EPDM), for Flush/Console mount
- HD CAK SX2-A1 : 1 x Front Console Mounting/Adapter Kit

Please see user manual/datasheet for more information

Factory Options:

- Projected Capacitive Touch Screen (Multitouch, USB, Pen/Glove supported)
- Color Calibrated models (ECDIS)
- 1 x Additional Composite Video IN (BNC) Connector

APPROVALS & CERTIFICATES

These products have been tested / type approved by the following classification societies:

IEC 60945 4th (EN 60945:2002)
CCS - China Classification Society

IACS E10

EU RO MR - Mutual Recognition

ClassNK - Nippon Kaiji Kyokai

Specifications - HD 26T22 MMD-xxx-Fxxx

All specifications are subject to change without prior notice!

TFT Technology:

- LED Backlight Technology, TFT Active-matrix
- 25.54 inch viewable image size, Widescreen, Aspect Ratio 16:10
- S-MVA (Multi-domain Vertical Alignment) Technology, RGB Vertical Stripe

TFT Characteristics:

- Native Resolution : 1920 x 1200
- Pixel Pitch (RGB) : 0.2865 (H) x 0.2865 (V) mm
- Response Time : 20ms (Tr+Tf)
- Contrast Ratio : 1500:1 (typical)
- Light Intensity : 350 cd/m² (typical)
- Viewable Angle : +/- 88 deg. (typical) (Up/Down/Left/Right)
- Active Display Area : 550.08 (H) x 343.8 (V) mm
- Max Colors : 16.7 million

Supported Signals:

Resolutions:

- VGA : 640 x 480 (including 640 x 350)
- SVGA : 800 x 600 (including 720 x 400)
- XGA : 1024 x 768
- SXGA : 1280 x 1024
- UXGA : 1600 x 1200
- FHD : 1920 x 1080
- WUXGA : 1920 x 1200*

* Recommended for optimal picture quality

Video Signals:

- Interlaced HDTV, NTSC, PAL and SECAM video
- Composite video

Power Specifications:

Multi-power Supply:

- 100-240V AC - 50/60Hz + 24 VDC

Note: You may connect either AC power or DC power or both. In case both sources are connected, power will be sourced from the AC input. If AC input is lost, there will be a uninterrupted switch-over to DC input.

Power Consumption:

- Operating AC/DC: 59W (max)

Physical Considerations:

- W:621.00 [24.45"] x H:435.00 [17.13"] x D:92.20 [3.62"] mm [inch]
- Weight: Approx. 14.6kg / 32.1lbs

Signal Terminals:

- DVI-I IN : 2 x 29p DVI Female (or as VGA IN with adapter)*
- DP1.2 IN : 1 x 20p DisplayPort (female)
- Comp. Video IN : 2 x BNC Connector (female)
- SCOM RS-422/485 : 2 x 5-pin Terminal Block 3.81, non-isolated+Buzzer
- SCOM+Touch : 1 x USB TYPE A Connector (female)
- SCOM Ethernet : 1 x RJ45 Connector for Remote Control
- SCOM RS-232 : 1 x 9p D-SUB (female) non-isolated+Buzzer
- VGA OUT : 1 x 15p HD D-SUB (female) - Clone of VGA IN**
- Potmeter/User : 1 x 9p D-SUB (male)
(Potentiometer IN, +5VDC OUT, BRT +/- IN)
- AC Power IN : 1 x Std IEC Inlet
- DC Power IN : 1 x 2-pin Terminal Block 5.08

* DVI-I Port #1 as VGA IN also acts as clone to VGA Signal Out (buffered).

**Tested at recommended resolutions. The VGA output signal (buffered) is at same resolution and sync as the VGA input. The output is working even if the display unit is turned off, but power cable/supply must be connected/provided.

Note for DVI and VGA signal inputs:

DVI-I #1, DVI-D #1 and VGA #1 is Single Link.
DVI-I #2, DVI-D #2 and VGA #2 is Dual Link.

User Controls:

Behind front bezel - Glass Display Control™ (GDC) IP66:

- Power On/Off, On Screen Display Menu, Brightness Control (-/+)
- Hotkeys (left/right), Mode Status Indicators (ECDIS, Service)
- Buzzer (through glass), Light Sensor (behind glass)

Environmental Considerations:

- Operating : Temperature -15°C to +55°C
- Storage : Temperature -30°C to +70°C
- Humidity : Up to 95%
- IP Rating : Protection: IP66 front – IP22 rear (EN60529)
- Compass Safe Dist. : Standard: 190cm - Steering: 110cm

Lifetime Considerations:

Even though the test conditions for bridge units provide for a maximum operating temperature of 55°C, continuous operation of all electronic components should, if possible, take place at ambient temperatures of only 25°C. This is a necessary prerequisite for long life and low service costs.

Available Accessories:

- HD CMB SX2-F1 : 1 x Console Mount Kit. EN60945 Tested
- HD TMB SX1-C1 : 1 x Table Mount Bracket. EN60945 Tested
- HD VED SX2-J1 : 1 x VESA Adapter (100/100 & 200/100mm)
Not EN60945 Tested
- HD REM SX1-A1 : 1 x External Remote Control, EN60945 Tested
- HD 26COV SX1-A1: 1 x UV Sun Cover
- JH 26TAP STD-A1 : 1 x Frame Adapter for Series 1 Cutout (retrofit)
- HD 26TAP SX1-A1 : 1 x Frame Adapter for JH 27T11 MMD Cutout(Retrofit)
- P007178 : 1 x IP66 Mount Gasket (EPDM), for Flush/Console mount

Please see user manual/datasheet for more information

Factory Options:

- Projected Capacitive Touch Screen (Multitouch, USB, Pen/Glove supported)
- Optical Bonding Technology
- Color Calibrated models (ECDIS)
- 1 x Additional Composite Video IN (BNC) Connector

APPROVALS & CERTIFICATES

These products have been tested / type approved by the following classification societies:

IEC 60945 4th (EN 60945:2002)
CCS - China Classification Society

IACS E10

EU RO MR - Mutual Recognition

ClassNK - Nippon Kaiji Kyokai

Specifications - HD 27T22 MMD-xxx-Fxxx

All specifications are subject to change without prior notice!

TFT Technology:

- LED Backlight Technology, Color Active Matrix
- 27.0 inch viewable image size, Widescreen, Aspect Ratio 16:9
- a-SI (amorphous silicon) Thin Film Transistor (TFT)

TFT Characteristics:

- Native Resolution : 1920 x 1080 (FHD)
- Pixel Pitch (RGB) : 0.31125 (H) x 0.31125 (V) mm
- Response Time : 12 ms (typical) (on/off)
- Contrast Ratio : 3000:1 (typical)
- Light Intensity : 300 cd/m² (typical)
- Viewable Angle : +/- 89 deg. (typical) (Up/Down/Left/Right)
- Active Display Area : 597.6 (H) x 336.15 (V) mm
- Max Colors : 16.7 million

Supported Signals:

Resolutions:

- VGA : 640 x 480 (including 640 x 350)
- SVGA : 800 x 600 (including 720 x 400)
- XGA : 1024 x 768
- SXGA : 1280 x 1024
- UXGA : 1600 x 1200
- FHD : 1920 x 1080*

* Recommended for optimal picture quality

Video Signals:

- Interlaced HDTV, NTSC, PAL and SECAM video
- Composite video

Power Specifications:

Multi-power Supply:

- 100-240V AC - 50/60Hz + 24 VDC

Note: You may connect either AC power or DC power or both. In case both sources are connected, power will be sourced from the AC input. If AC input is lost, there will be a uninterrupted switch-over to DC input.

Power Consumption:

- Operating AC/DC: 44W (max)

Physical Considerations:

- W:650.00 [25.59"] x H:437.00 [17.20"] x D:69.50 [2.74"] mm [inch]
- Weight: Approx. 11.0kg / 24.2lbs

Signal Terminals:

- DVI-I IN : 2 x 29p DVI Female (or as VGA IN with adapter)*
- DP1.2 IN : 1 x 20p DisplayPort (female)
- Comp. Video IN : 2 x BNC Connector (female)
- SCOM RS-422/485 : 2 x 5-pin Terminal Block 3.81, non-isolated+Buzzer
- SCOM+Touch : 1 x USB TYPE A Connector (female)
- SCOM Ethernet : 1 x RJ45 Connector for Remote Control
- SCOM RS-232 : 1 x 9p D-SUB (female) non-isolated+Buzzer
- VGA OUT : 1 x 15p HD D-SUB (female) - Clone of VGA IN**
- Potmeter/User : 1 x 9p D-SUB (male)
(Potentiometer IN, +5VDC OUT, BRT +/- IN)
- AC Power IN : 1 x Std IEC Inlet
- DC Power IN : 1 x 2-pin Terminal Block 5.08

* DVI-I Port #1 as VGA IN also acts as clone to VGA Signal Out (buffered).

**Tested at recommended resolutions. The VGA output signal (buffered) is at same resolution and sync as the VGA input. The output is working even if the display unit is turned off, but power cable/supply must be connected/provided.

Note for DVI and VGA signal inputs:

DVI-I #1, DVI-D #1 and VGA #1 is Single Link.
DVI-I #2, DVI-D #2 and VGA #2 is Dual Link.

User Controls:

Behind front bezel - Glass Display Control™ (GDC) IP66:

- Power On/Off, On Screen Display Menu, Brightness Control (-/+)
- Hotkeys (left/right), Mode Status Indicators (ECDIS, Service)
- Buzzer (through glass), Light Sensor (behind glass)

Environmental Considerations:

- Operating : Temperature -15°C to +55°C
- Storage : Temperature -30°C to +70°C
- Humidity : Up to 95%
- IP Rating : Protection: IP66 front – IP22 rear (EN60529)
- Compass Safe Dist. : Standard: 190cm – Steering: 110cm

Lifetime Considerations:

Even though the test conditions for bridge units provide for a maximum operating temperature of 55°C, continuous operation of all electronic components should, if possible, take place at ambient temperatures of only 25°C. This is a necessary prerequisite for long life and low service costs.

Available Accessories:

- HD CMB SX2-E1 : 1 x Console Mount Kit. EN60945 Tested
 - HD TMB SX1-C1 : 1 x Table Mount Bracket. EN60945 Tested
 - HD VED SX2-K1 : 1 x VESA Adapter (100/100 & 200/100mm)
Not EN60945 Tested
 - HD REM SX1-A1 : 1 x External Remote Control, EN60945 Tested
 - HD 27COV SX1-A1 : 1 x UV Sun Cover
 - P018743 : 1 x IP66 Mount Gasket (EPDM), for Flush/Console mount
 - HD CAK SX2-B1 : 1 x Front Console Mounting/Adapter Kit
- Please see user manual/datasheet for more information

Factory Options:

- Projected Capacitive Touch Screen (Multitouch, USB, Pen/Glove supported)
- Optical Bonding Technology
- Color Calibrated models (ECDIS)
- 1 x Additional Composite Video IN (BNC) Connector

APPROVALS & CERTIFICATES

These products have been tested / type approved by the following classification societies:

IEC 60945 4th (EN 60945:2002)
CCS - China Classification Society

IACS E10

EU RO MR - Mutual Recognition

ClassNK - Nippon Kaiji Kyokai

This page left intentionally blank



Technical Drawings

Technical Drawings - HD 15T22 MMD-xxx-Fxxx

Dimensions might be shown with or without decimals and indicated as mm [inches]. Tolerance on drawings is +/- 1mm. For accurate measurements, check relevant DWG file.

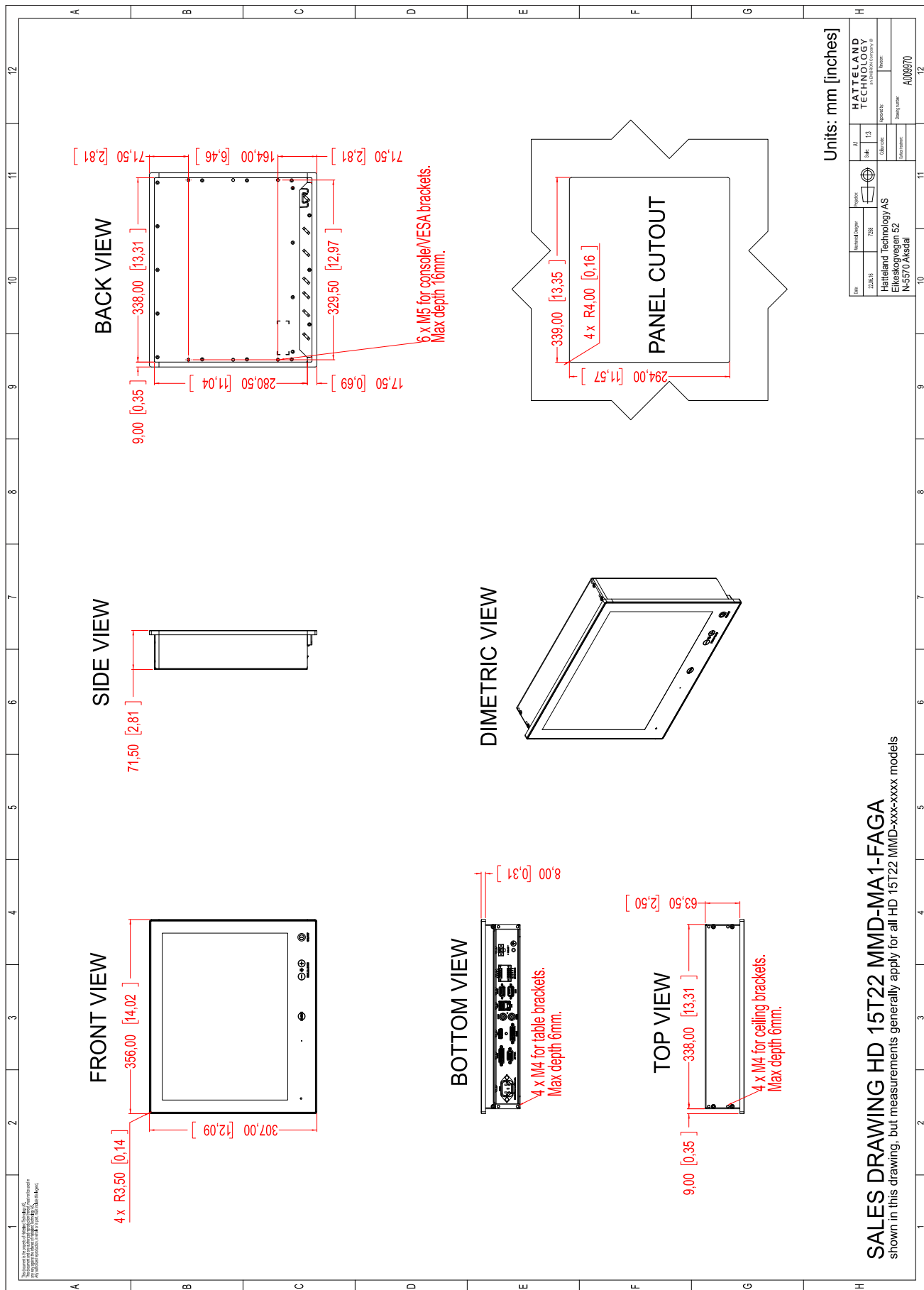

This document is the property of Hatteland Technology AS. This document and any authorized reproduction thereof, must not be used in any way against the interest of Hatteland Technology AS. Any authorized reproduction, in whole or in part, must include this legend. Hatteland Technology AS Proprietary information. Not to be distributed to any third party without written permission.

Technical Drawings - HD 15T22 MMD-xxx-FHxx

Dimensions might be shown with or without decimals and indicated as mm [inches]. Tolerance on drawings is +/- 1mm. For accurate measurements, check relevant DWG file.

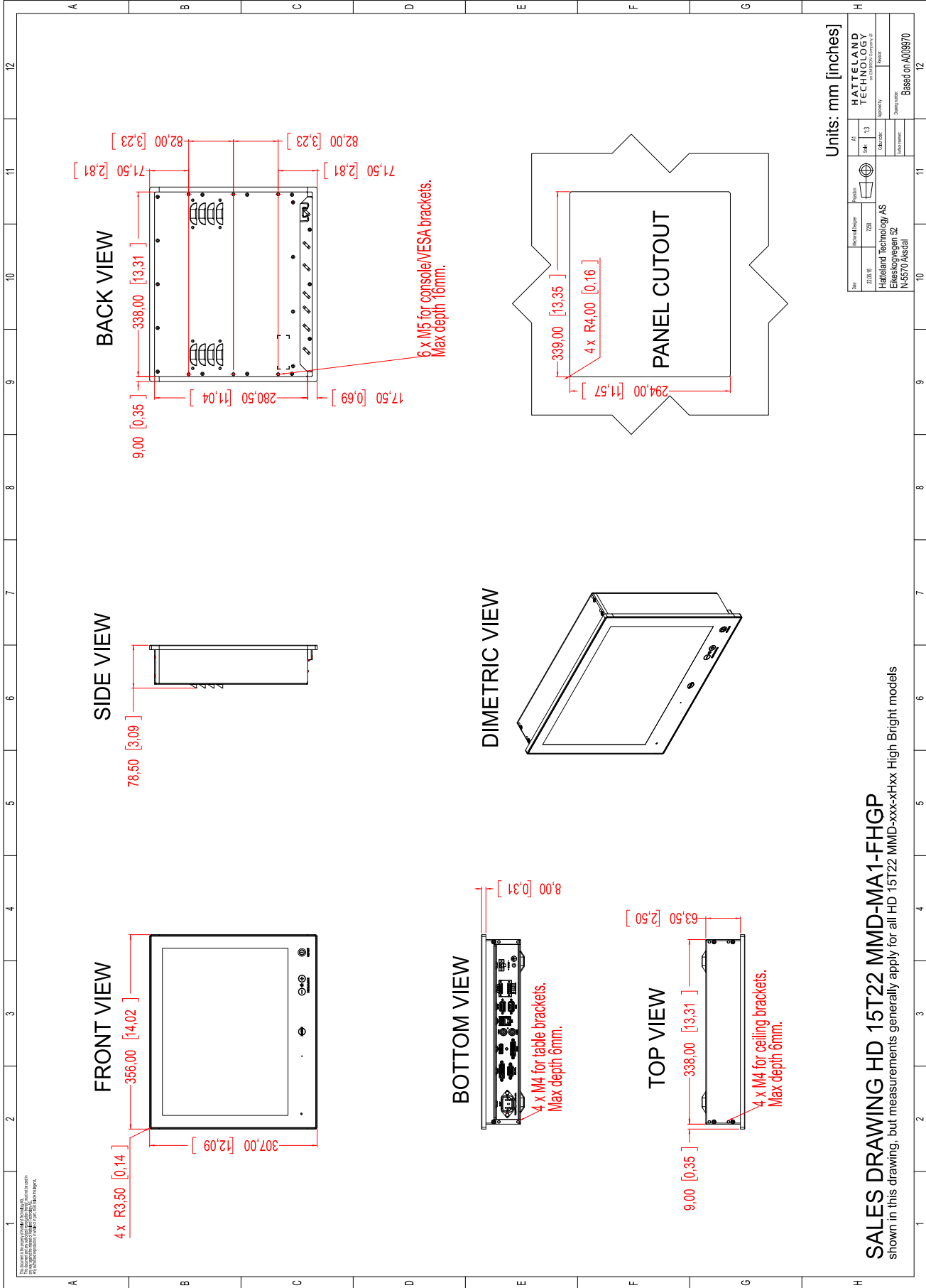

SALES DRAWING HD 15T22 MMD-MA1-FHGP
 shown in this drawing, but measurements generally apply for all HD 15T22 MMD-xxx-xHxx High Bright models

This document is the property of Hatteland Technology AS. This document and any authorized reproduction thereof, must not be used in any way against the interest of Hatteland Technology AS. Any authorized reproduction, in whole or in part, must include this legend. Hatteland Technology AS Proprietary information. Not to be distributed to any third party without written permission.

Technical Drawings - HD 17T22 MMD-xxx-Fxxx

Dimensions might be shown with or without decimals and indicated as mm [inches]. Tolerance on drawings is +/- 1mm. For accurate measurements, check relevant DWG file.

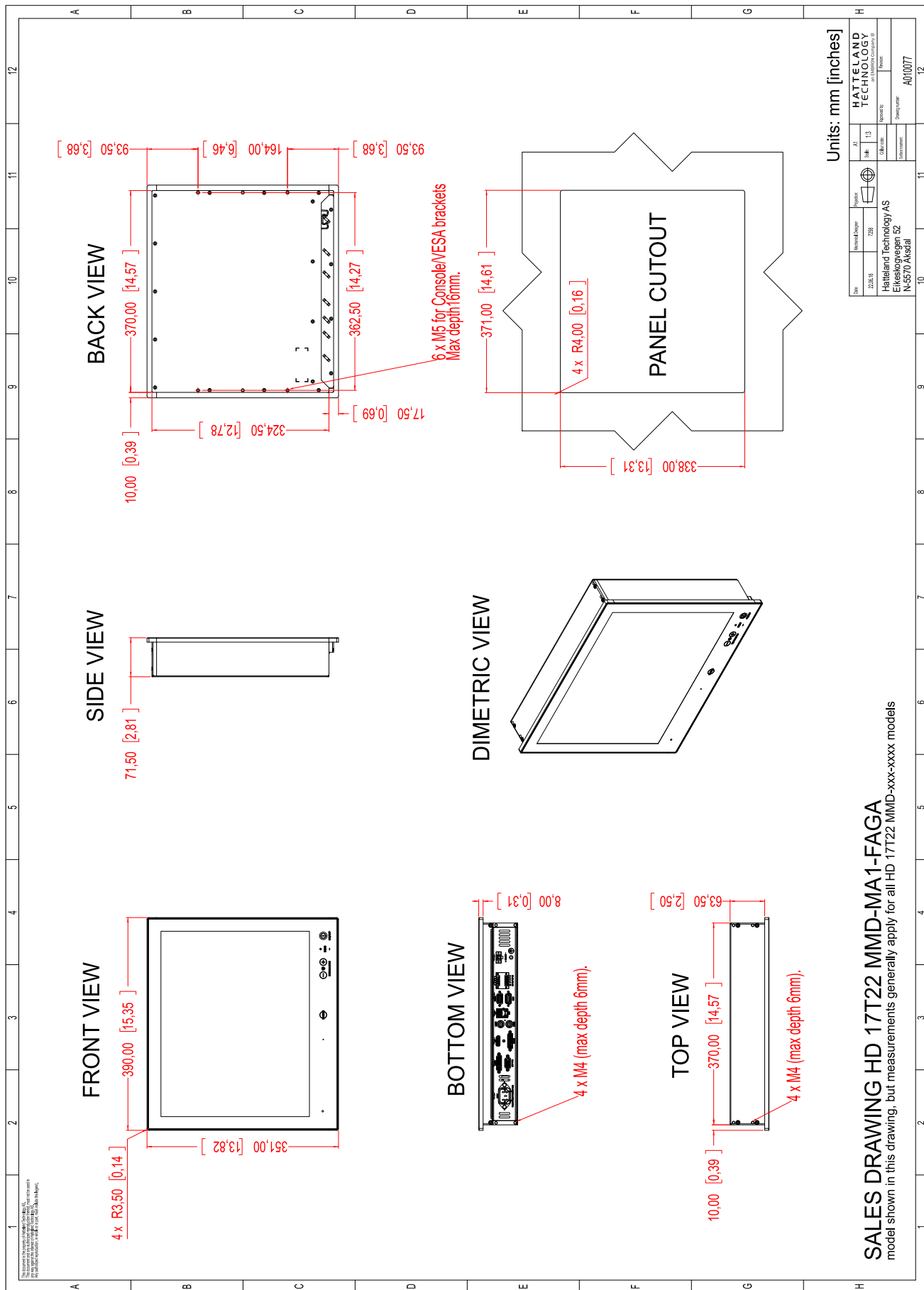

SALES DRAWING HD 17T22 MMD-MA1-FAGA
 model shown in this drawing, but measurements generally apply for all HD 17T22 MMD-xxx-xxxx models

This document is the property of Hatteland Technology AS. This document and any authorized reproduction thereof, must not be used in any way against the interest of Hatteland Technology AS. Any authorized reproduction, in whole or in part, must include this legend. Hatteland Technology AS Proprietary information. Not to be distributed to any third party without written permission.

Technical Drawings - HD 17T22 MMD-xxx-FHxx

Dimensions might be shown with or without decimals and indicated as mm [inches]. Tolerance on drawings is +/- 1mm. For accurate measurements, check relevant DWG file.

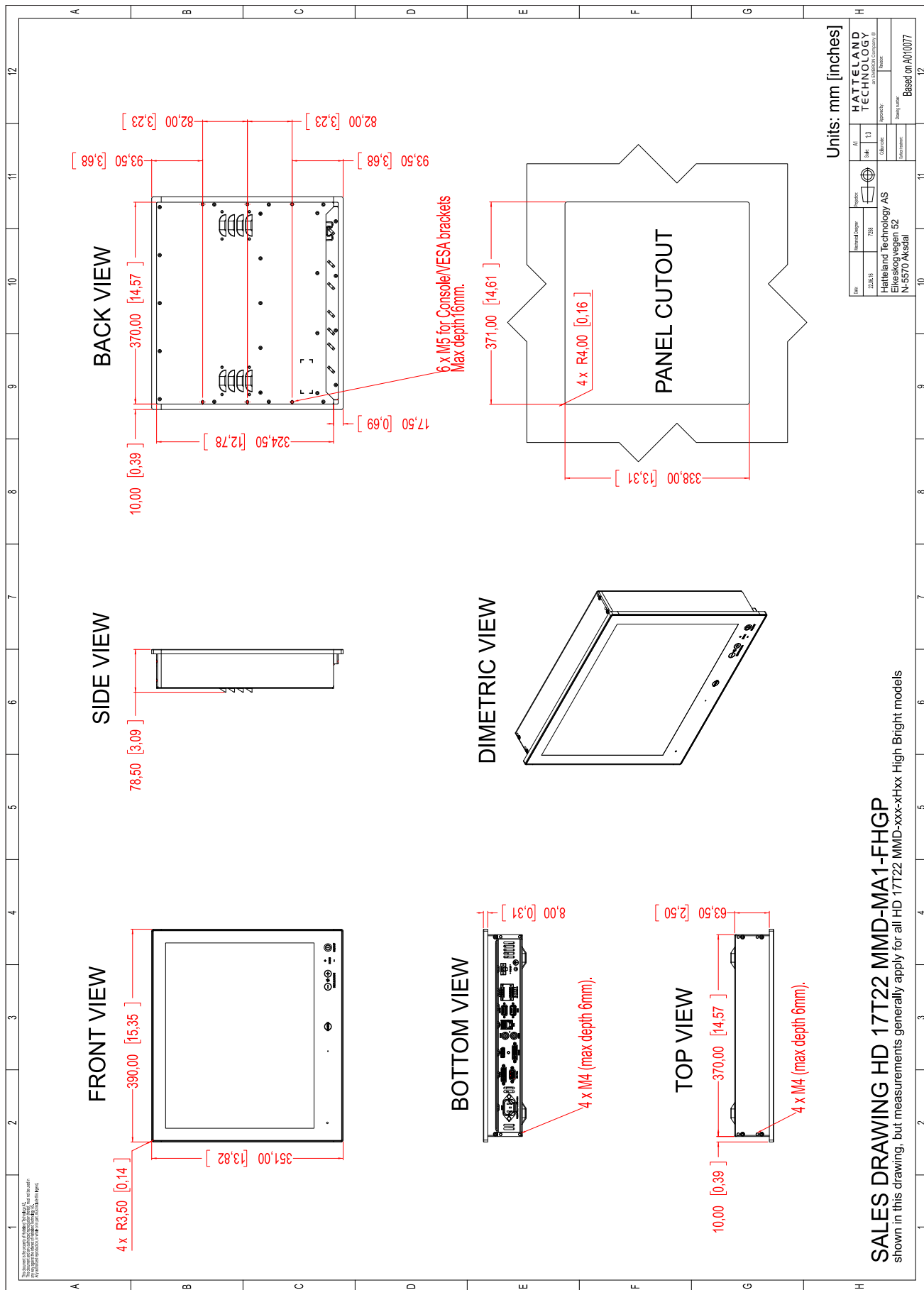

SALES DRAWING HD 17T22 MMD-MA1-FHGP
 shown in this drawing, but measurements generally apply for all HD 17T22 MMD-xxx-xHxx High Bright models

This document is the property of Hatteland Technology AS. This document and any authorized reproduction thereof, must not be used in any way against the interest of Hatteland Technology AS. Any authorized reproduction, in whole or in part, must include this legend. Hatteland Technology AS Proprietary information. Not to be distributed to any third party without written permission.

Technical Drawings - HD 19T22 MMD-xxx-FHxx

Dimensions might be shown with or without decimals and indicated as mm [inches]. Tolerance on drawings is +/- 1mm. For accurate measurements, check relevant DWG file.

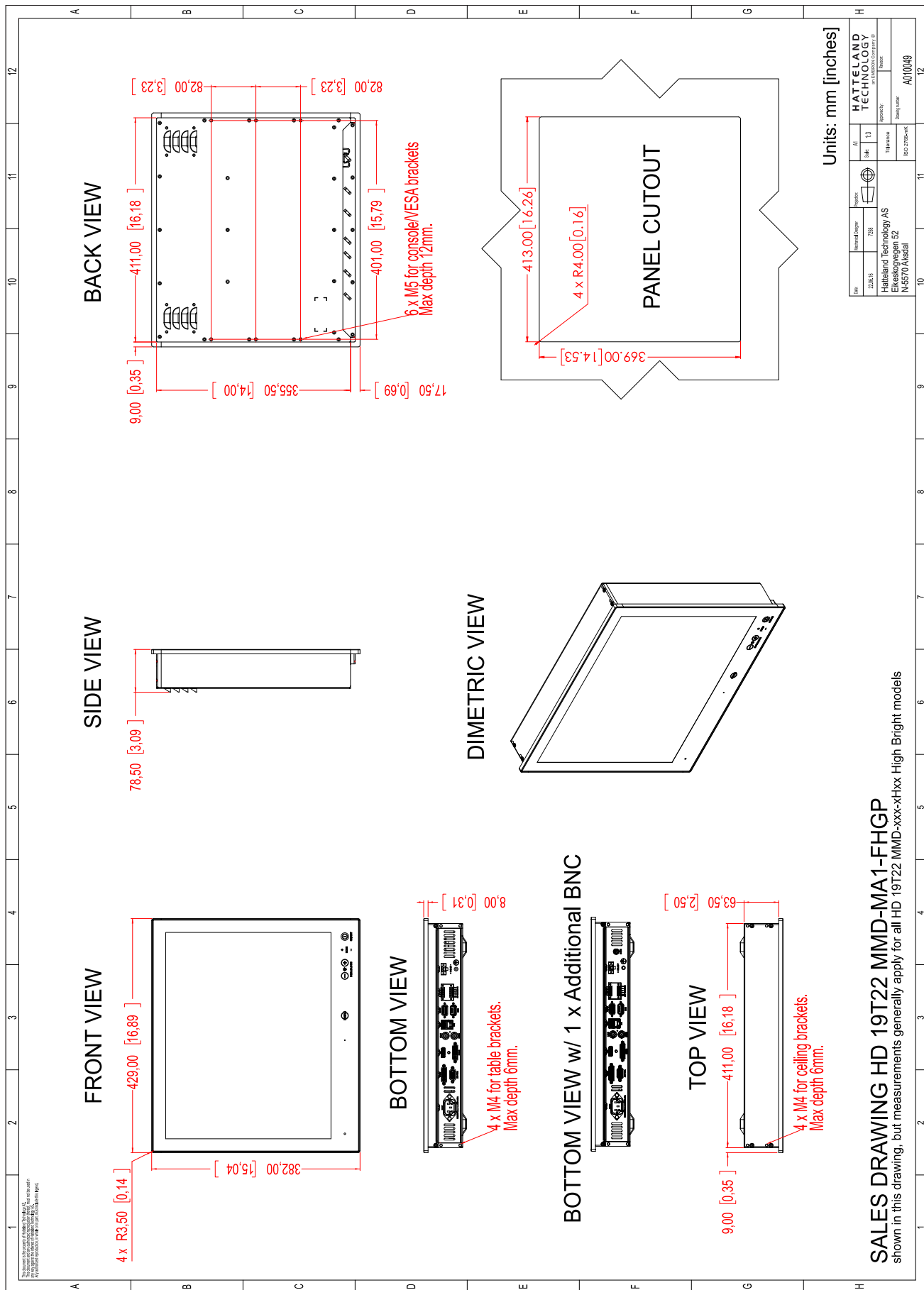

SALES DRAWING HD 19T22 MMD-MA1-FHGP
 shown in this drawing, but measurements generally apply for all HD 19T22 MMD-xxx-xHxx High Bright models

This document is the property of Hatteland Technology AS. This document and any authorized reproduction thereof, must not be used in any way against the interest of Hatteland Technology AS. Any authorized reproduction, in whole or in part, must include this legend. Hatteland Technology AS Proprietary information. Not to be distributed to any third party without written permission.

Technical Drawings - HD 24T22 MMD-xxx-Fxxx

Dimensions might be shown with or without decimals and indicated as mm [inches]. Tolerance on drawings is +/- 1mm. For accurate measurements, check relevant DWG file.

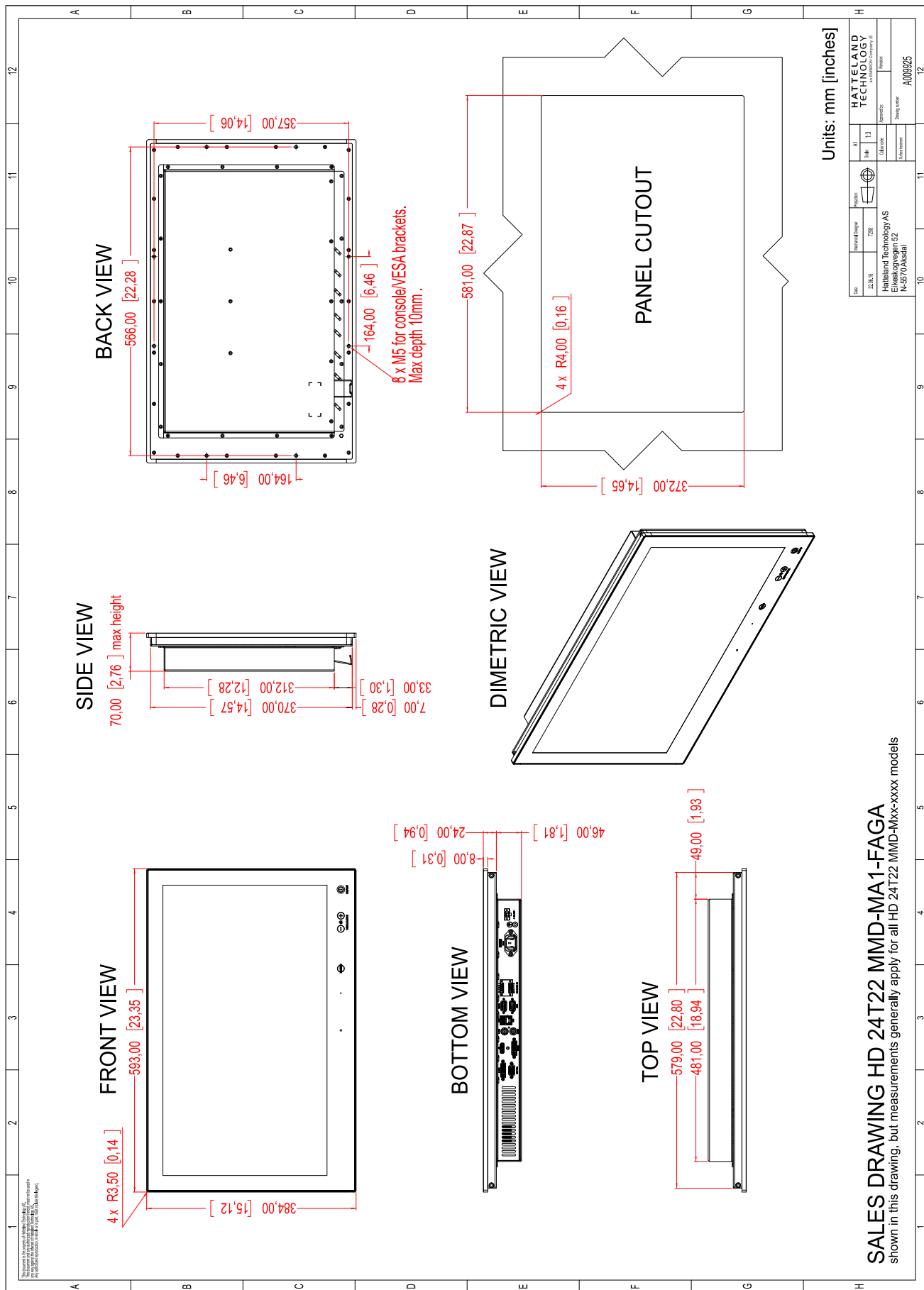

SALES DRAWING HD 24T22 MMD-MA1-FAGA
 shown in this drawing, but measurements generally apply for all HD 24T22 MMD-Mxx-xxxx models

This document is the property of Hatteland Technology AS. This document and any authorized reproduction thereof, must not be used in any way against the interest of Hatteland Technology AS. Any authorized reproduction, in whole or in part, must include this legend. Hatteland Technology AS Proprietary information. Not to be distributed to any third party without written permission.

Technical Drawings - HD 24T22 MMD-xxx-FHxx

Dimensions might be shown with or without decimals and indicated as mm [inches]. Tolerance on drawings is +/- 1mm. For accurate measurements, check relevant DWG file.

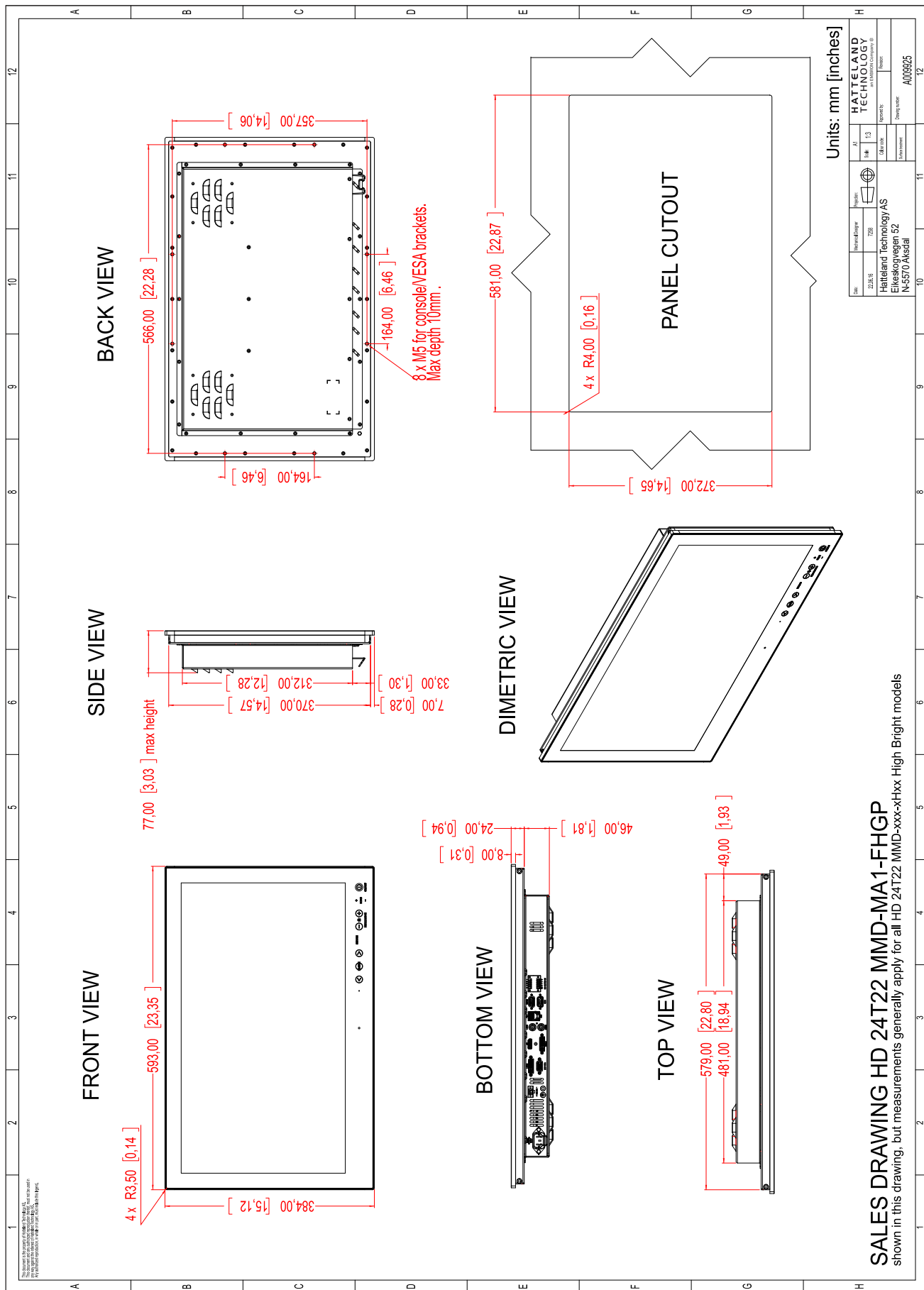

SALES DRAWING HD 24T22 MMD-MA1-FHGP
 shown in this drawing, but measurements generally apply for all HD 24T22 MMD-xxx-xrxx High Bright models

This document is the property of Hatteland Technology AS. This document and any authorized reproduction thereof, must not be used in any way against the interest of Hatteland Technology AS. Any authorized reproduction, in whole or in part, must include this legend. Hatteland Technology AS Proprietary information. Not to be distributed to any third party without written permission.

Technical Drawings - HD 26T22 MMD-xxx-Fxxx

Dimensions might be shown with or without decimals and indicated as mm [inches]. Tolerance on drawings is +/- 1mm. For accurate measurements, check relevant DWG file.

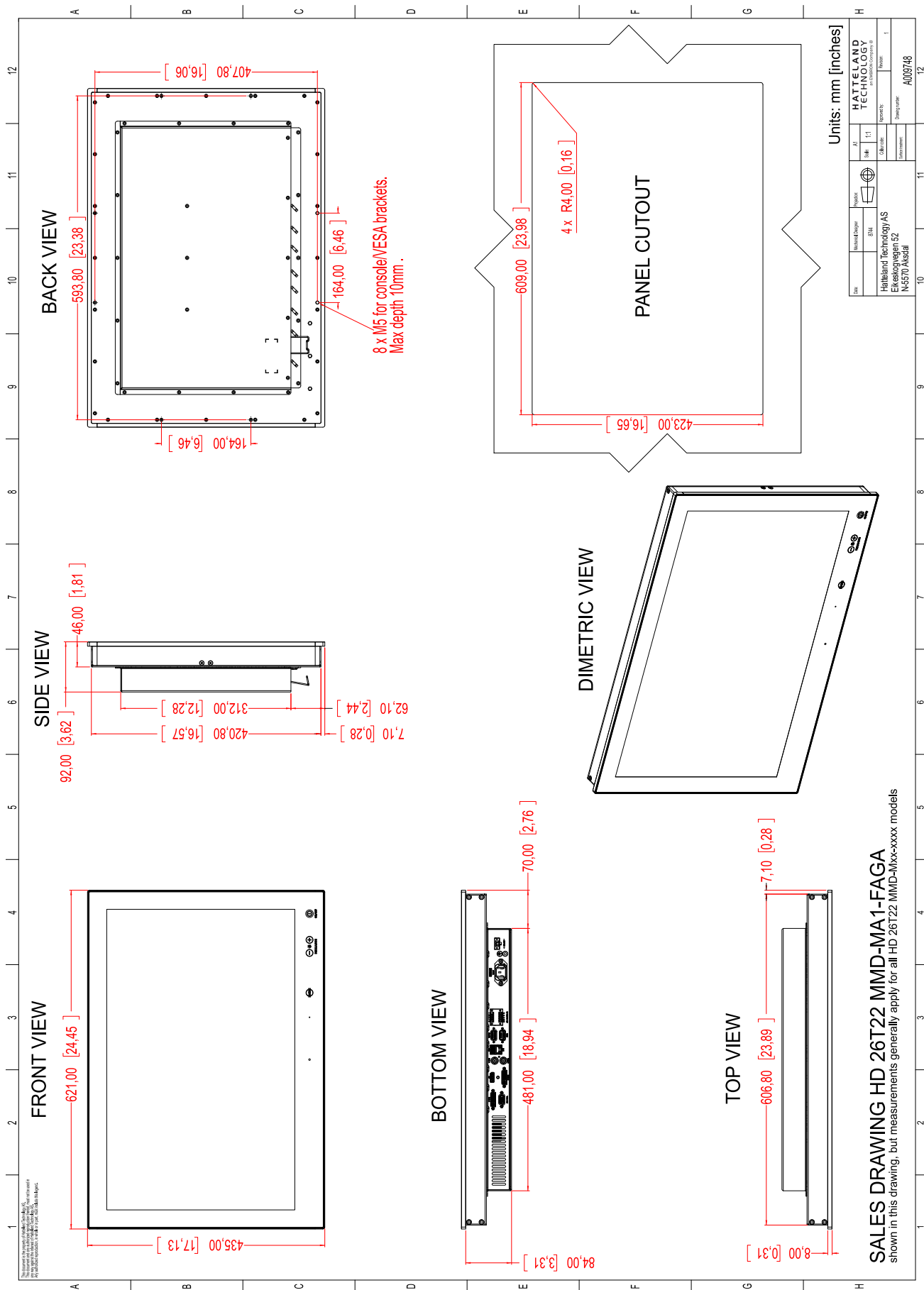

This document is the property of Hatteland Technology AS. This document and any authorized reproduction thereof, must not be used in any way against the interest of Hatteland Technology AS. Any authorized reproduction, in whole or in part, must include this legend. Hatteland Technology AS Proprietary information. Not to be distributed to any third party without written permission.

This page left intentionally blank



Technical Drawings - Accessories

Technical Drawings - HD TMB SX2-A1

Dimensions might be shown with or without decimals and indicated as mm [inches]. Tolerance on drawings is +/- 1mm. For accurate measurements, check relevant DWG file.

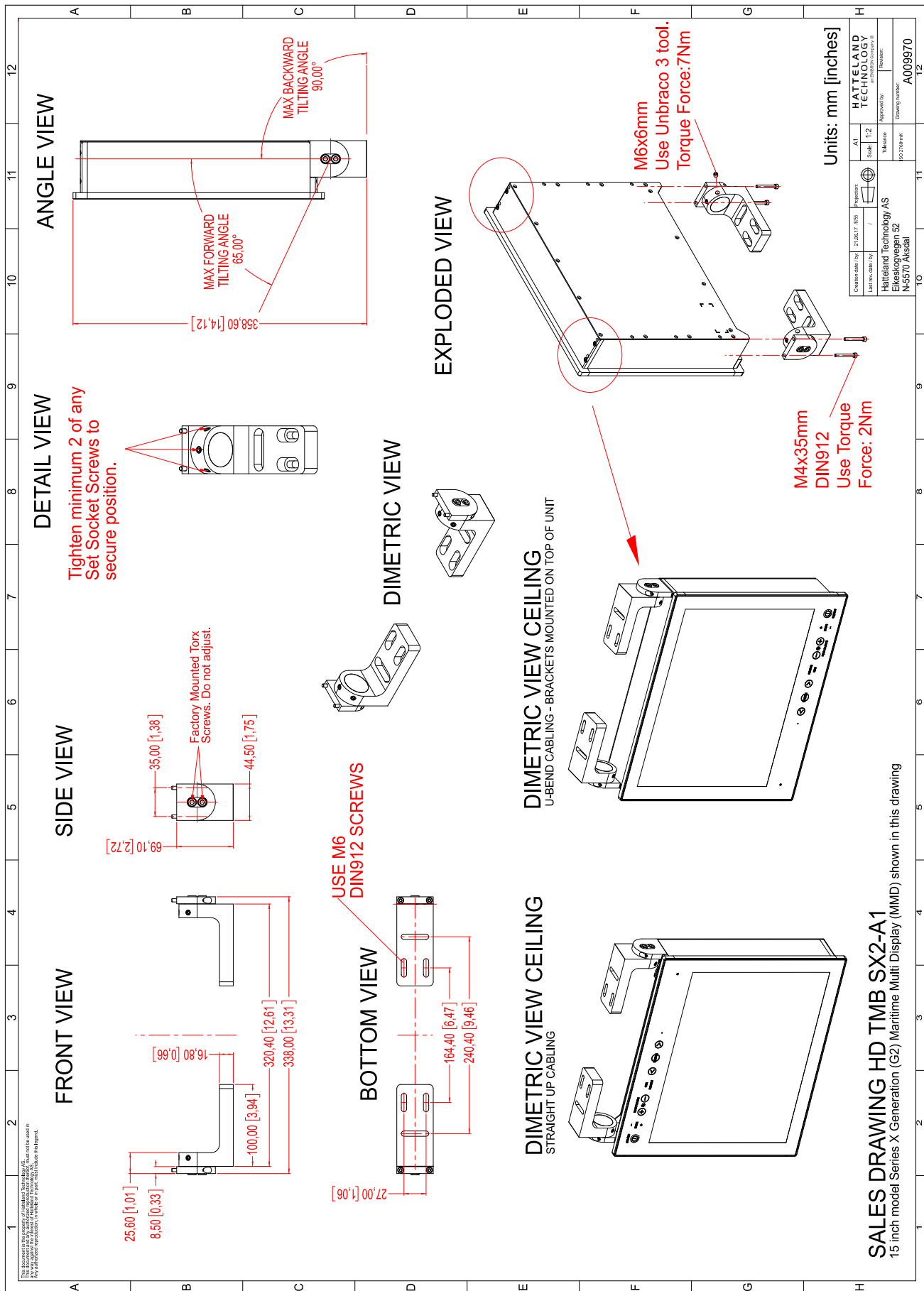

This document is the property of Hatteland Technology AS. This document and any authorized reproduction thereof, must not be used in any way against the interest of Hatteland Technology AS. Any authorized reproduction, in whole or in part, must include this legend. Hatteland Technology AS Proprietary information. Not to be distributed to any third party without written permission.

Technical Drawings - HD TMB SX2-A1

Dimensions might be shown with or without decimals and indicated as mm [inches]. Tolerance on drawings is +/- 1mm. For accurate measurements, check relevant DWG file.

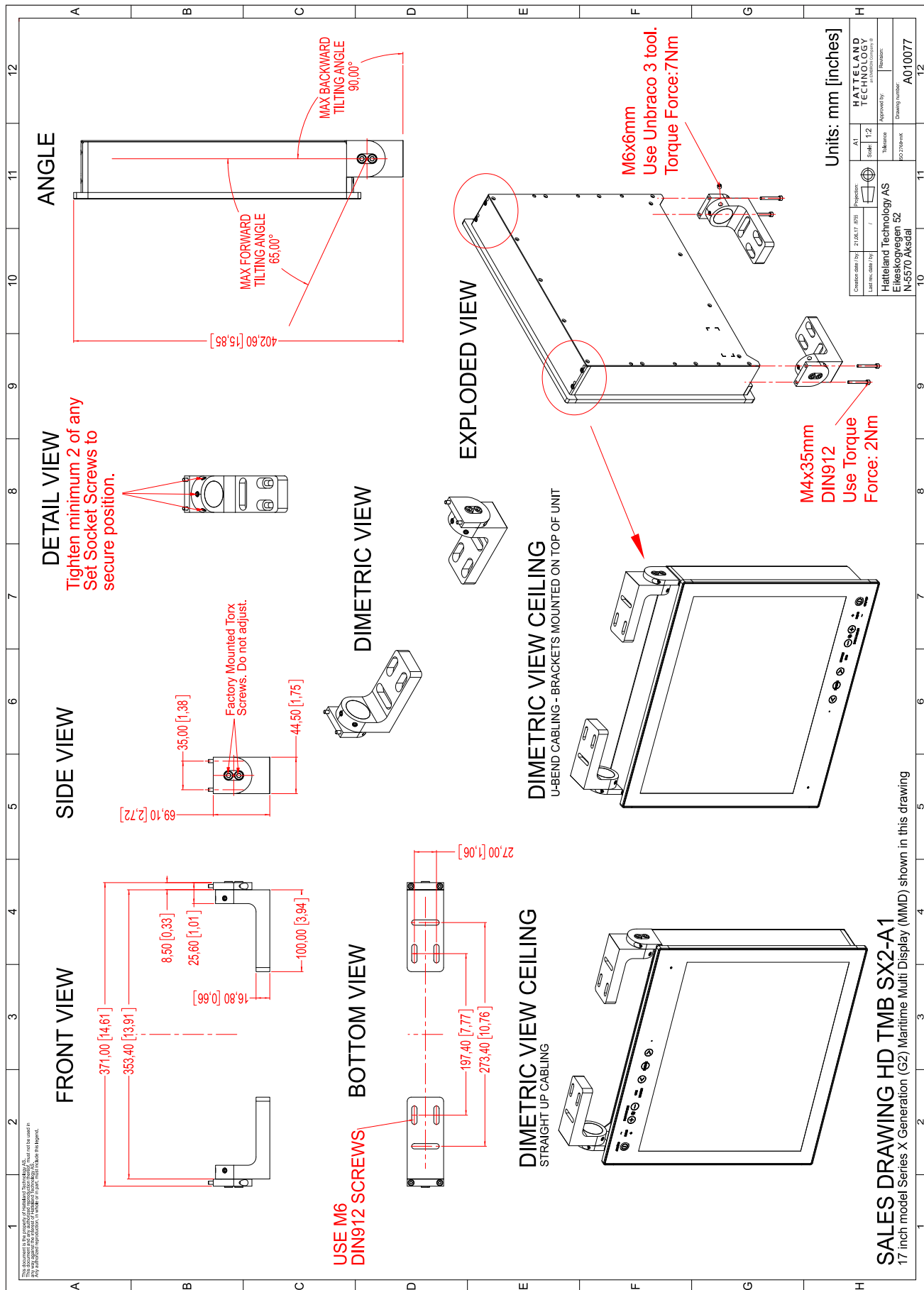

This document is the property of Hatteland Technology AS. This document and any authorized reproduction thereof, must not be used in any way against the interest of Hatteland Technology AS. Any authorized reproduction, in whole or in part, must include this legend. Hatteland Technology AS Proprietary information. Not to be distributed to any third party without written permission.

Technical Drawings - HD TMB SX2-A1

Dimensions might be shown with or without decimals and indicated as mm [inches]. Tolerance on drawings is +/- 1mm. For accurate measurements, check relevant DWG file.

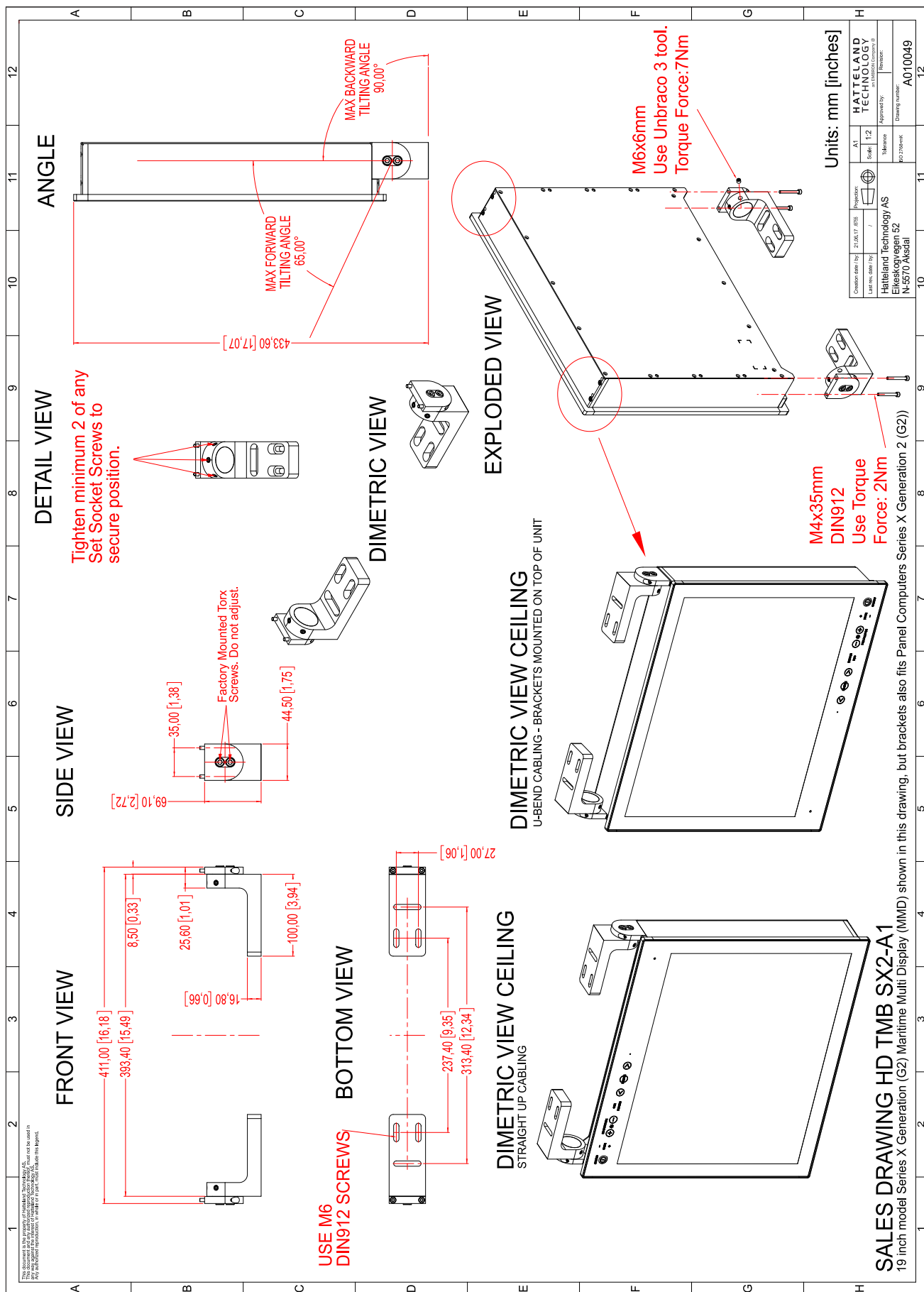

This document is the property of Hatteland Technology AS. This document and any authorized reproduction thereof, must not be used in any way against the interest of Hatteland Technology AS. Any authorized reproduction, in whole or in part, must include this legend. Hatteland Technology AS Proprietary information. Not to be distributed to any third party without written permission.

Technical Drawings - HD TMB SX1-C1

Dimensions might be shown with or without decimals and indicated as mm [inches]. Tolerance on drawings is +/- 1mm. For accurate measurements, check relevant DWG file.

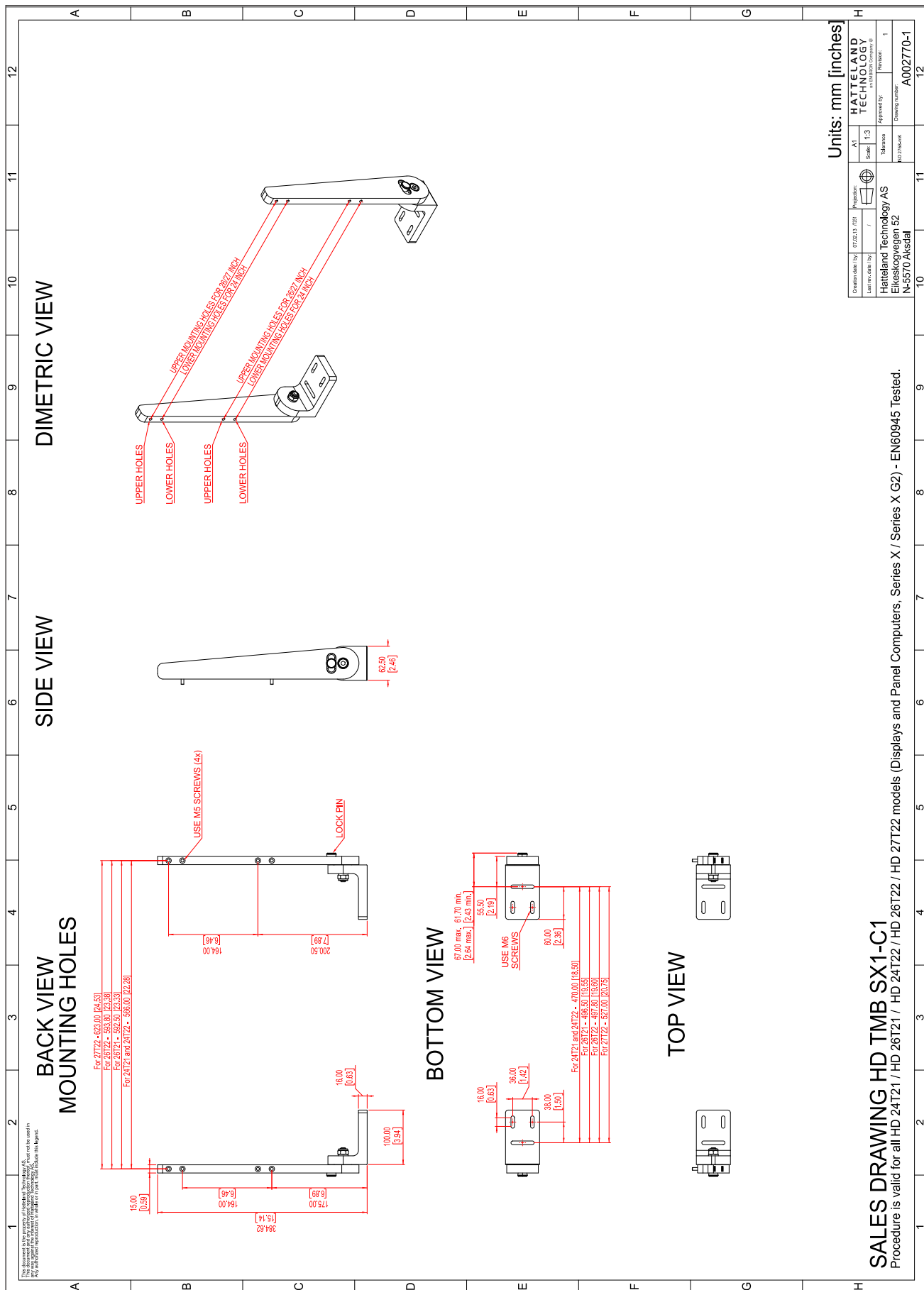

Desktop/Table Mounting Bracket 24/26/27 inch **111**

This document is the property of Hatteland Technology AS. This document and any authorized reproduction thereof, must not be used in any way against the interest of Hatteland Technology AS. Any authorized reproduction, in whole or in part, must include this legend. Hatteland Technology AS Proprietary information. Not to be distributed to any third party without written permission.

Technical Drawings - HD TMB SX1-C1

Dimensions might be shown with or without decimals and indicated as mm [inches]. Tolerance on drawings is +/- 1mm. For accurate measurements, check relevant DWG file.

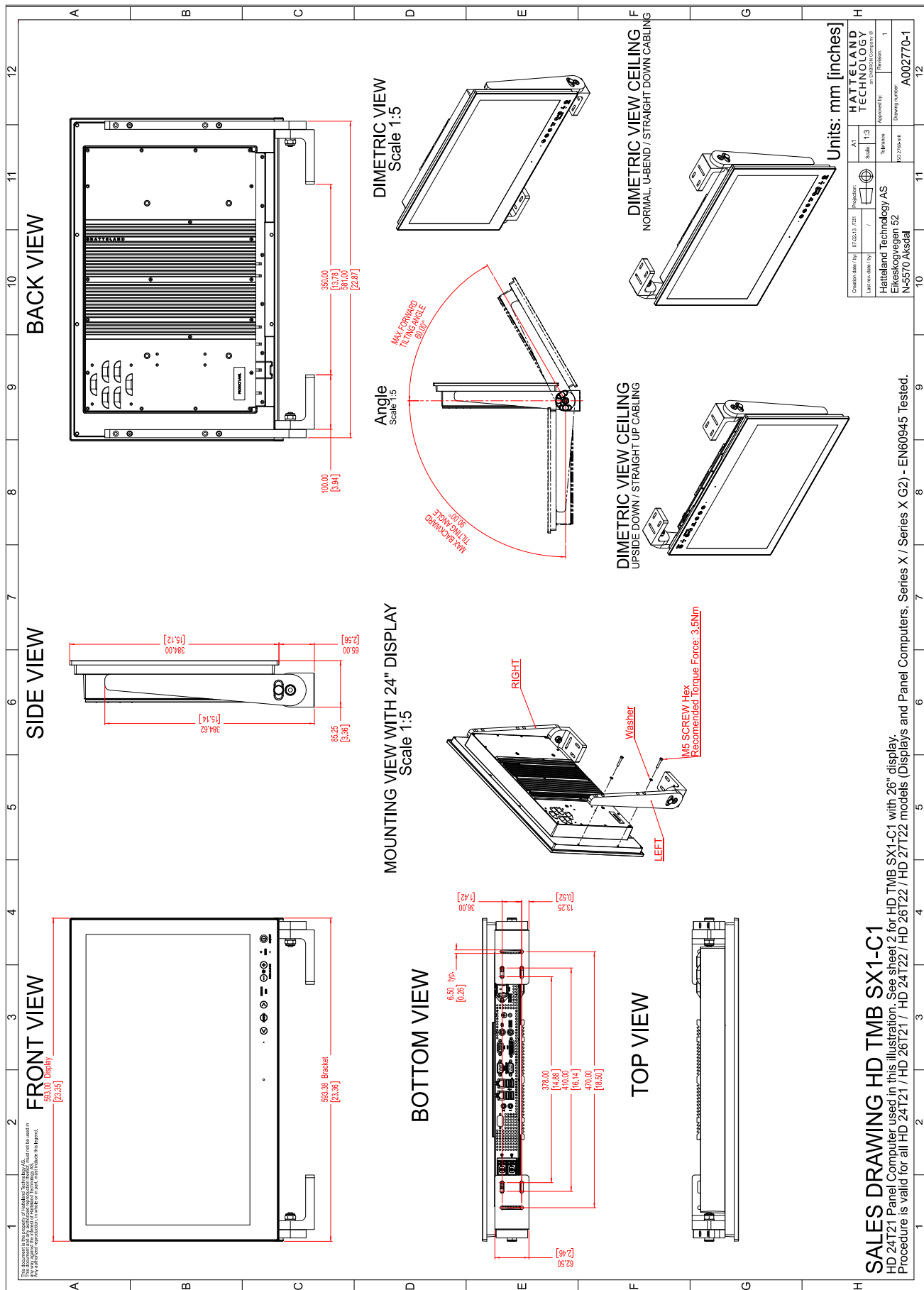

SALES DRAWING HD TMB SX1-C1

HD 24T21 Panel Computer used in this illustration. See sheet 2 for HD TMB SX1-C1 with 26" display. Procedure is valid for all HD 24T21 / HD 26T22 / HD 27T22 models (Displays and Panel Computers, Series X / Series X G2) - EN60945 Tested.

This document is the property of Hatteland Technology AS. This document and any authorized reproduction thereof, must not be used in any way against the interest of Hatteland Technology AS. Any authorized reproduction, in whole or in part, must include this legend. Hatteland Technology AS Proprietary information. Not to be distributed to any third party without written permission.

Technical Drawings - HD TMB SX1-C1

Dimensions might be shown with or without decimals and indicated as mm [inches]. Tolerance on drawings is +/- 1mm. For accurate measurements, check relevant DWG file.

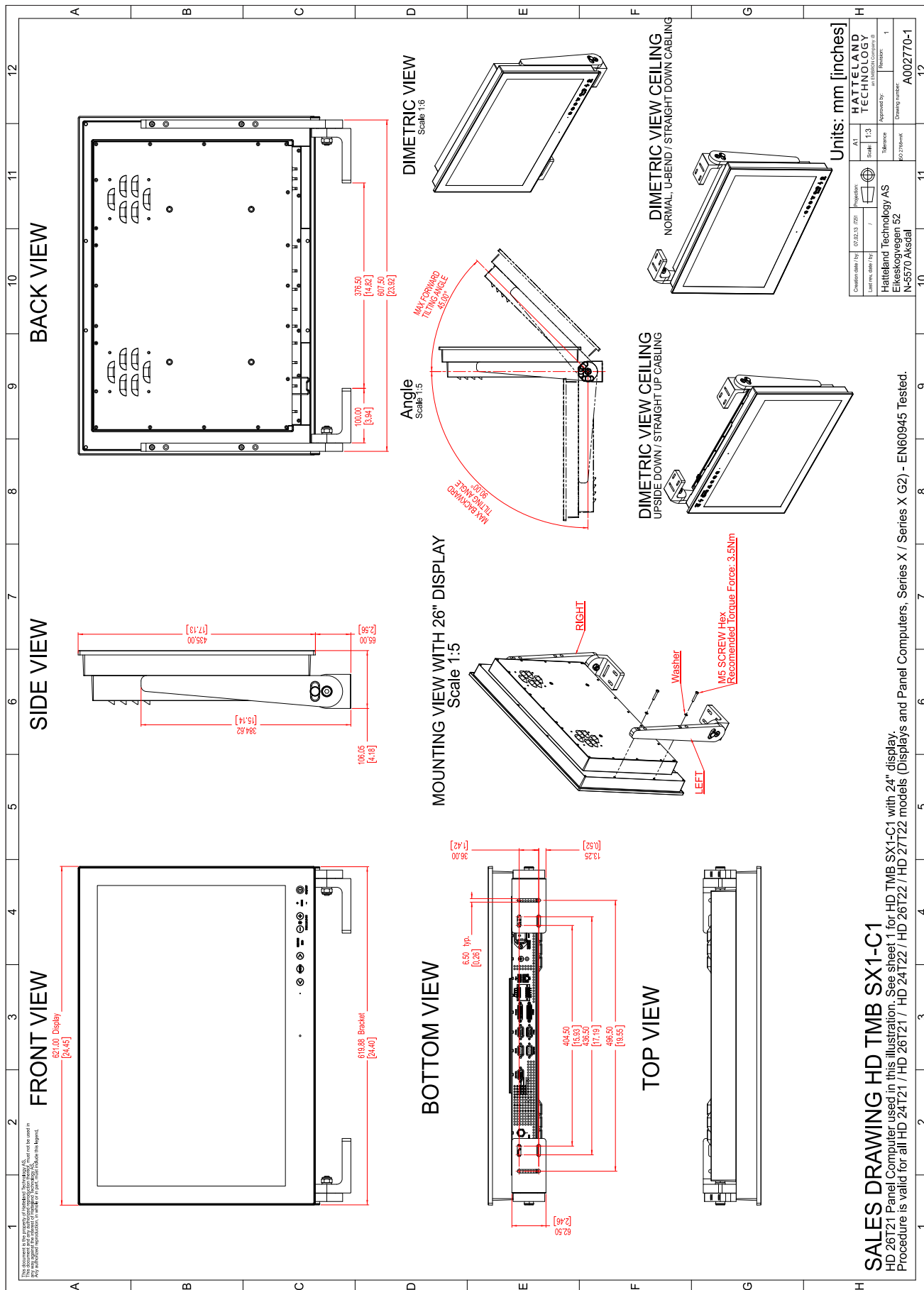

SALES DRAWING HD TMB SX1-C1

HD 26T21 Panel Computer used in this illustration. See sheet 1 for HD TMB SX1-C1 with 24" display. Procedure is valid for all HD 24T21 / HD 26T21 / HD 24T22 / HD 26T22 / HD 27T22 models (Displays and Panel Computers, Series X / Series X G2) - EN60945 Tested.

This document is the property of Hatteland Technology AS. This document and any authorized reproduction thereof, must not be used in any way against the interest of Hatteland Technology AS. Any authorized reproduction, in whole or in part, must include this legend. Hatteland Technology AS Proprietary information. Not to be distributed to any third party without written permission.

Technical Drawings - HD CMB SX2-A1

Dimensions might be shown with or without decimals and indicated as mm [inches]. Tolerance on drawings is +/- 1mm. For accurate measurements, check relevant DWG file.

This document is the property of Hatteland Technology AS.
This document and any authorized reproduction thereof, must not be used in
any unauthorized reproduction, in whole or in part, must include this legend.

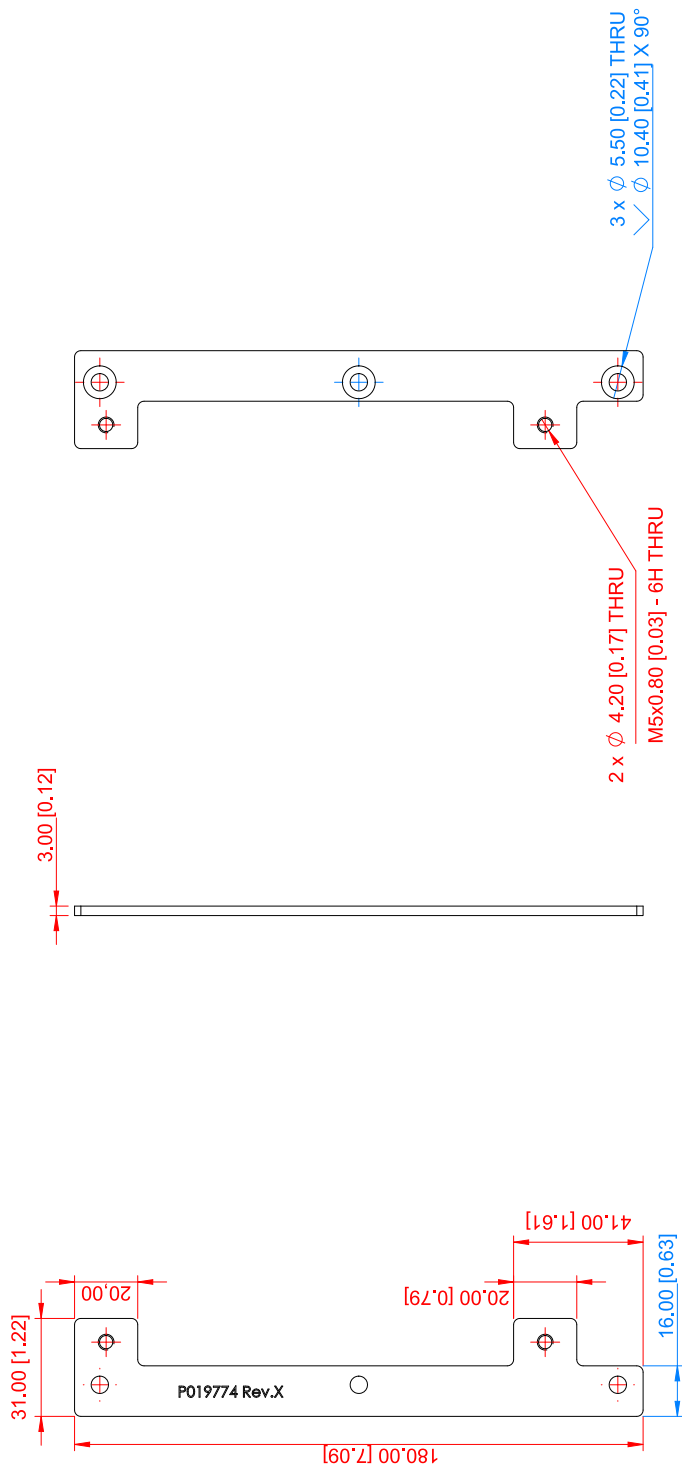

Units: mm [inches]

Description		Material	
xxT22 Console Bracket		AISI 304	
HATTELAND TECHNOLOGY an EMBRON Company			
Creation date / by:	24.11.16 / 7258	Drawing size: A4	Approved by: 8744
Last rev. date / by:	/	Scale: 1:2	Revision: 02
Hatteland Technology AS Eikeskogvegen 52 N-5570 Aksdal		Projection:	Colour code:
		Sheet 1 / 1	Surface treatment:
		Tolerance	Welding specification
		ISO 2768-1 middel	NS-EN-288-4

SALES DRAWING HD CMB SX2-A1
Console Mount Bracket for 15, 17 and 19 inch Series X G2 MMC/MMD

Drawing number:

P019774

This document is the property of Hatteland Technology AS. This document and any authorized reproduction thereof, must not be used in any way against the interest of Hatteland Technology AS. Any authorized reproduction, in whole or in part, must include this legend. Hatteland Technology AS Proprietary information. Not to be distributed to any third party without written permission.

Technical Drawings - HD CMB SX2-A1

Dimensions might be shown with or without decimals and indicated as mm [inches]. Tolerance on drawings is +/- 1mm. For accurate measurements, check relevant DWG file.

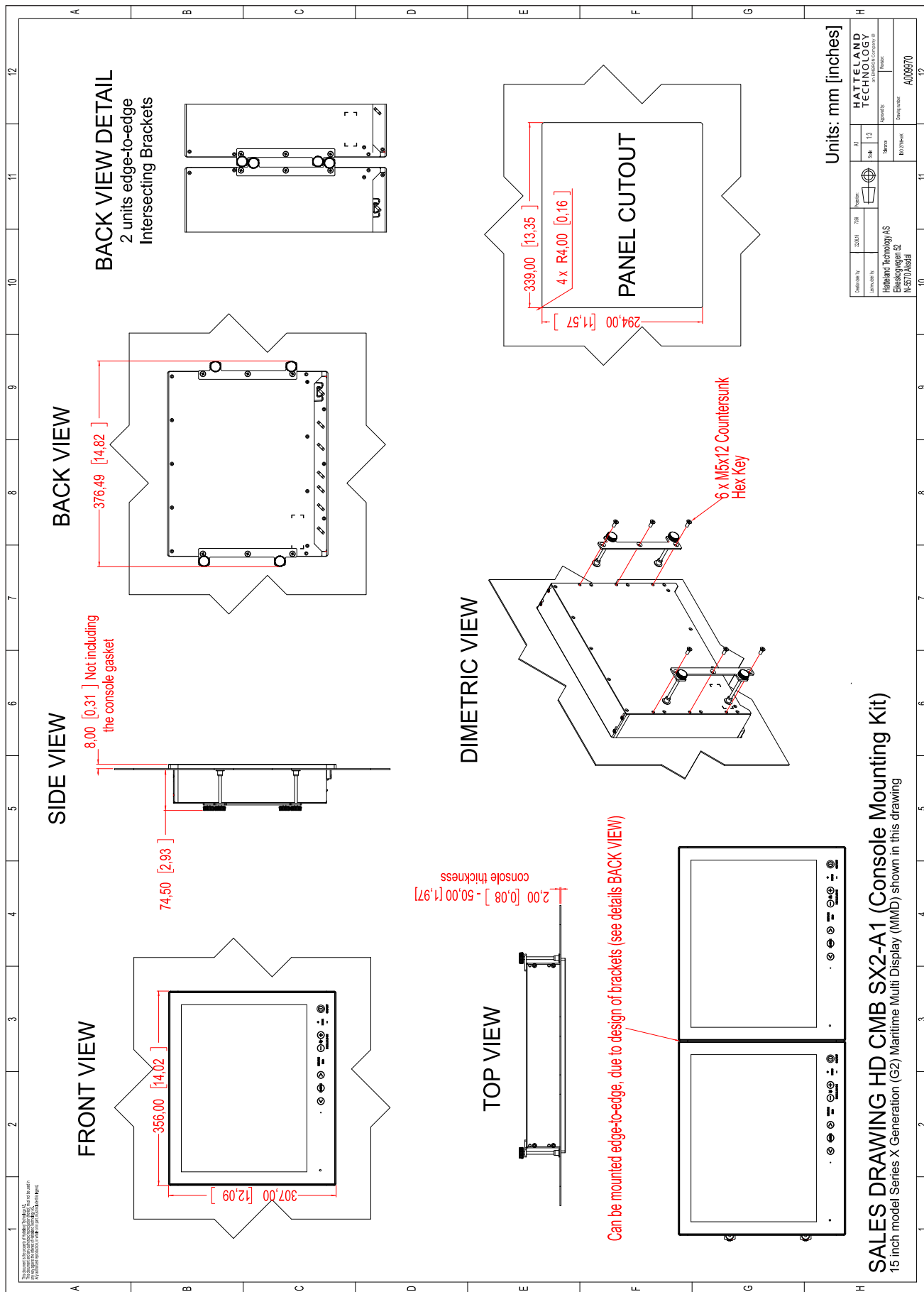

Technical Drawings - HD CMB SX2-A1

Dimensions might be shown with or without decimals and indicated as mm [inches]. Tolerance on drawings is +/- 1mm. For accurate measurements, check relevant DWG file.

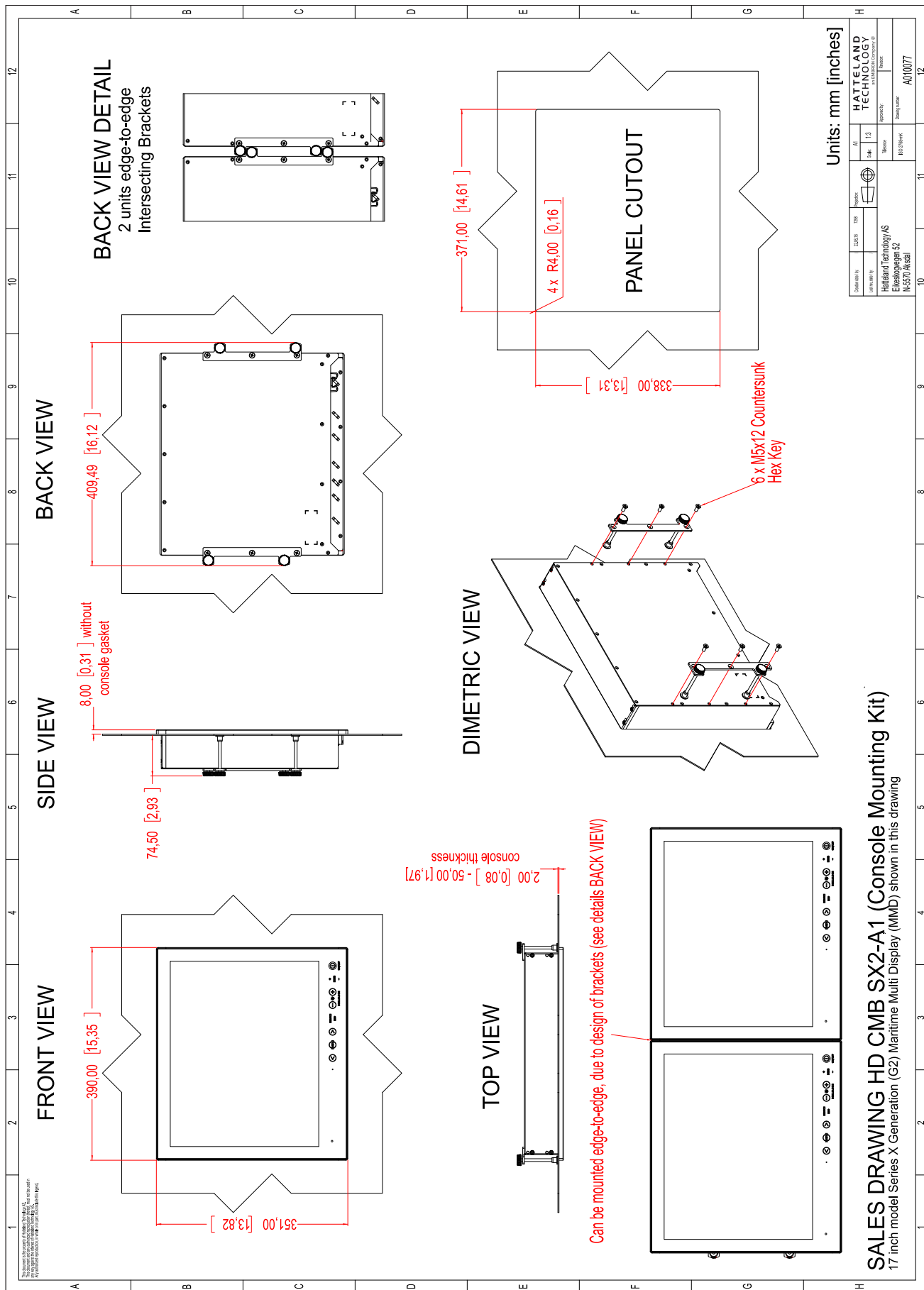

Can be mounted edge-to-edge, due to design of brackets (see details BACK VIEW)

This document is the property of Hatteland Technology AS. This document and any authorized reproduction thereof, must not be used in any way against the interest of Hatteland Technology AS. Any authorized reproduction, in whole or in part, must include this legend. Hatteland Technology AS Proprietary information. Not to be distributed to any third party without written permission.

Technical Drawings - HD CMB SX2-A1

Dimensions might be shown with or without decimals and indicated as mm [inches]. Tolerance on drawings is +/- 1mm. For accurate measurements, check relevant DWG file.

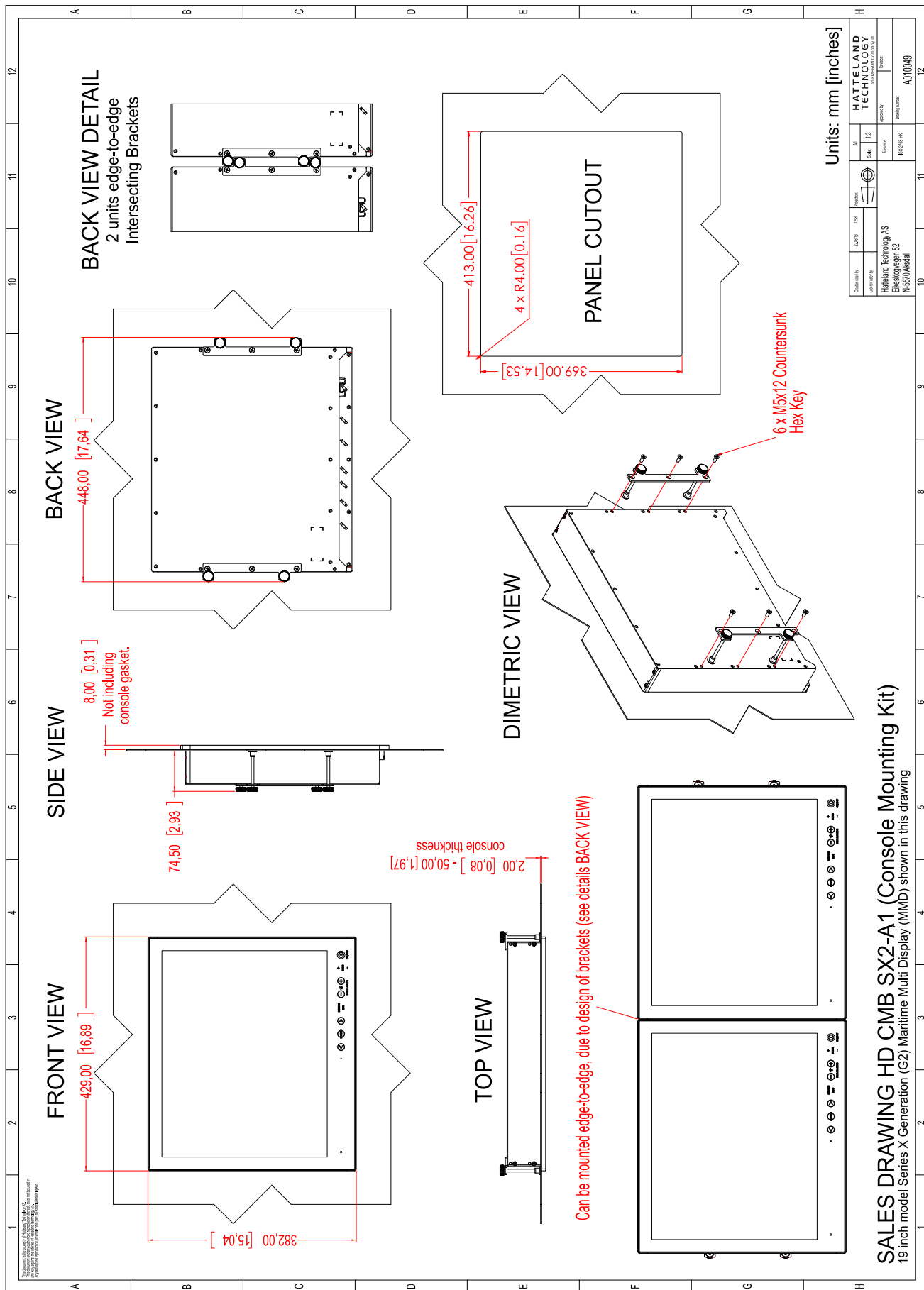

This document is the property of Hatteland Technology AS. This document and any authorized reproduction thereof, must not be used in any way against the interest of Hatteland Technology AS. Any authorized reproduction, in whole or in part, must include this legend. Hatteland Technology AS Proprietary information. Not to be distributed to any third party without written permission.

Dimensions might be shown with or without decimals and indicated as mm [inches]. Tolerance on drawings is +/- 1mm. For accurate measurements, check relevant DWG file.

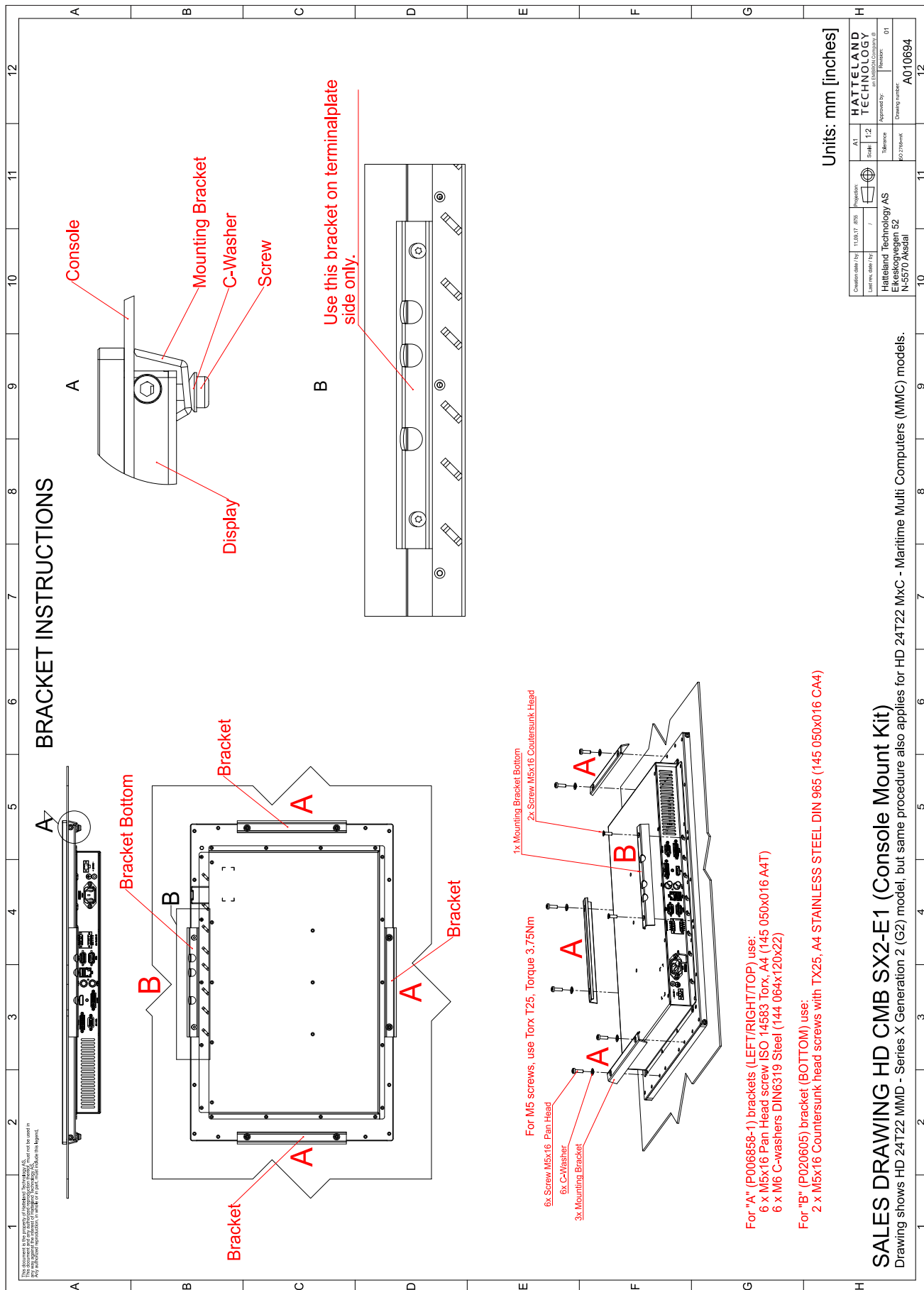

SALES DRAWING HD CMB SX2-E1 (Console Mount Kit)

Drawing shows HD 24T22 MMD - Series X Generation 2 (G2) model, but same procedure also applies for HD 24T22 MkC - Maritime Multi Computers (MMC) models.

This document is the property of Hatteland Technology AS. This document and any authorized reproduction thereof, must not be used in any way against the interest of Hatteland Technology AS. Any authorized reproduction, in whole or in part, must include this legend. Hatteland Technology AS Proprietary information. Not to be distributed to any third party without written permission.

Technical Drawings - HD CMB SX2-E1

Dimensions might be shown with or without decimals and indicated as mm [inches]. Tolerance on drawings is +/- 1mm. For accurate measurements, check relevant DWG file.

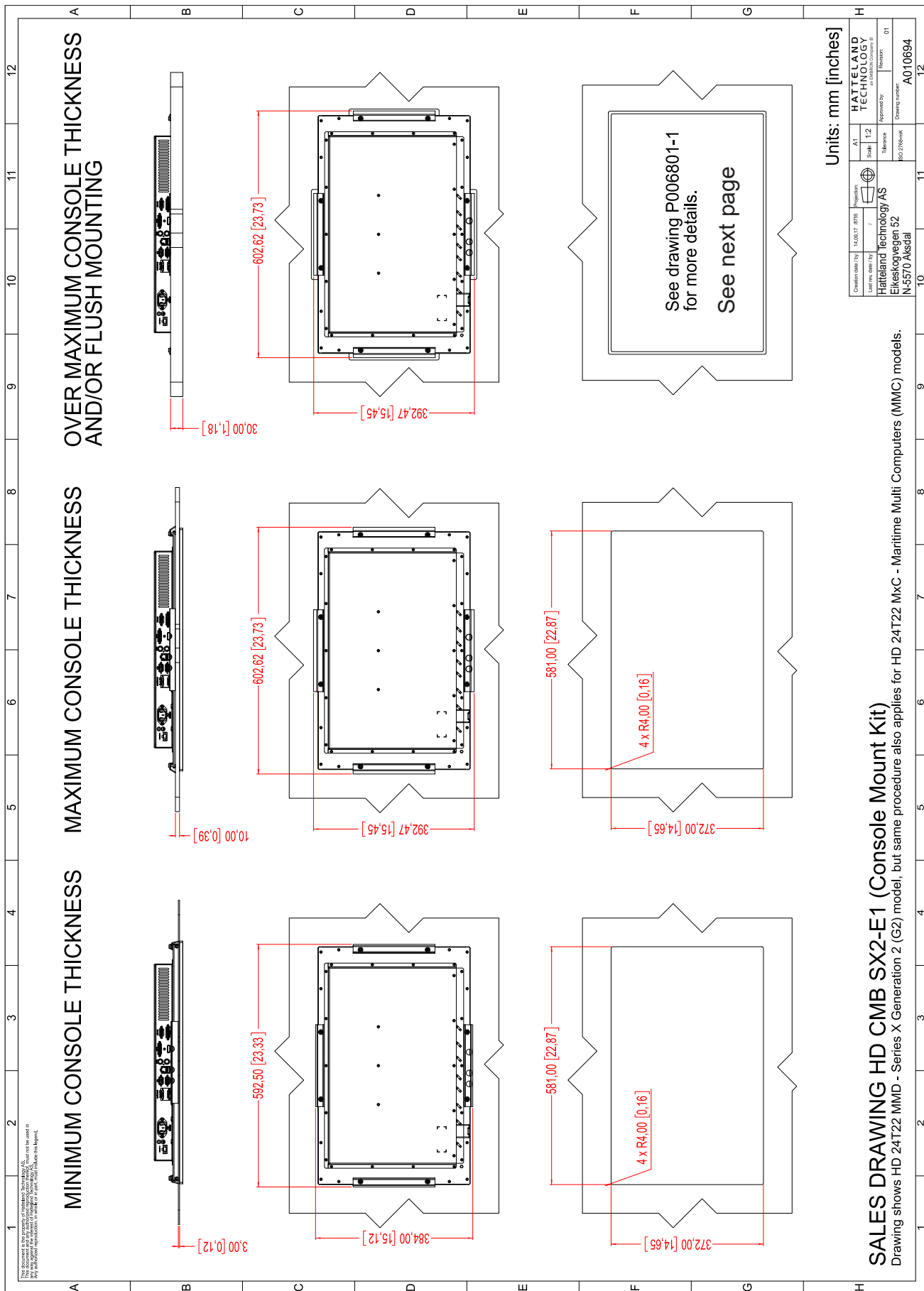

SALES DRAWING HD CMB SX2-E1 (Console Mount Kit)

Drawing shows HD 24T22 MMD - Series X Generation 2 (G2) model, but same procedure also applies for HD 24T22 MxC - Maritime Multi Computers (MMC) models.

This document is the property of Hatteland Technology AS. This document and any authorized reproduction thereof, must not be used in any way against the interest of Hatteland Technology AS. Any authorized reproduction, in whole or in part, must include this legend. Hatteland Technology AS Proprietary information. Not to be distributed to any third party without written permission.

Technical Drawings - HD CMB SX2-E1

Dimensions might be shown with or without decimals and indicated as mm [inches]. Tolerance on drawings is +/- 1mm. For accurate measurements, check relevant DWG file.

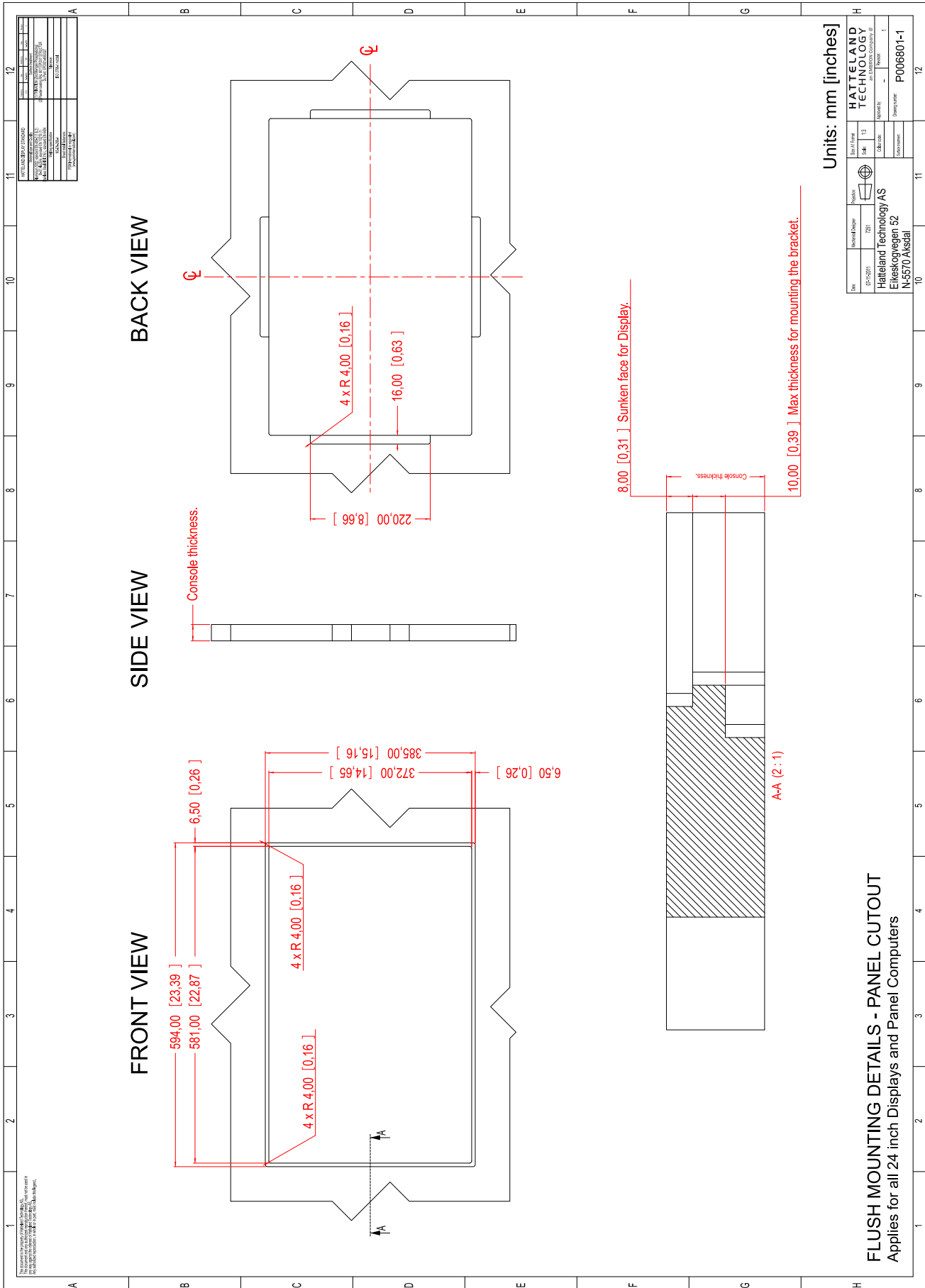

This document is the property of Hatteland Technology AS. This document and any authorized reproduction thereof, must not be used in any way against the interest of Hatteland Technology AS. Any authorized reproduction, in whole or in part, must include this legend. Hatteland Technology AS Proprietary information. Not to be distributed to any third party without written permission.

Dimensions might be shown with or without decimals and indicated as mm [inches]. Tolerance on drawings is +/- 1mm. For accurate measurements, check relevant DWG file.

BRACKET INSTRUCTIONS

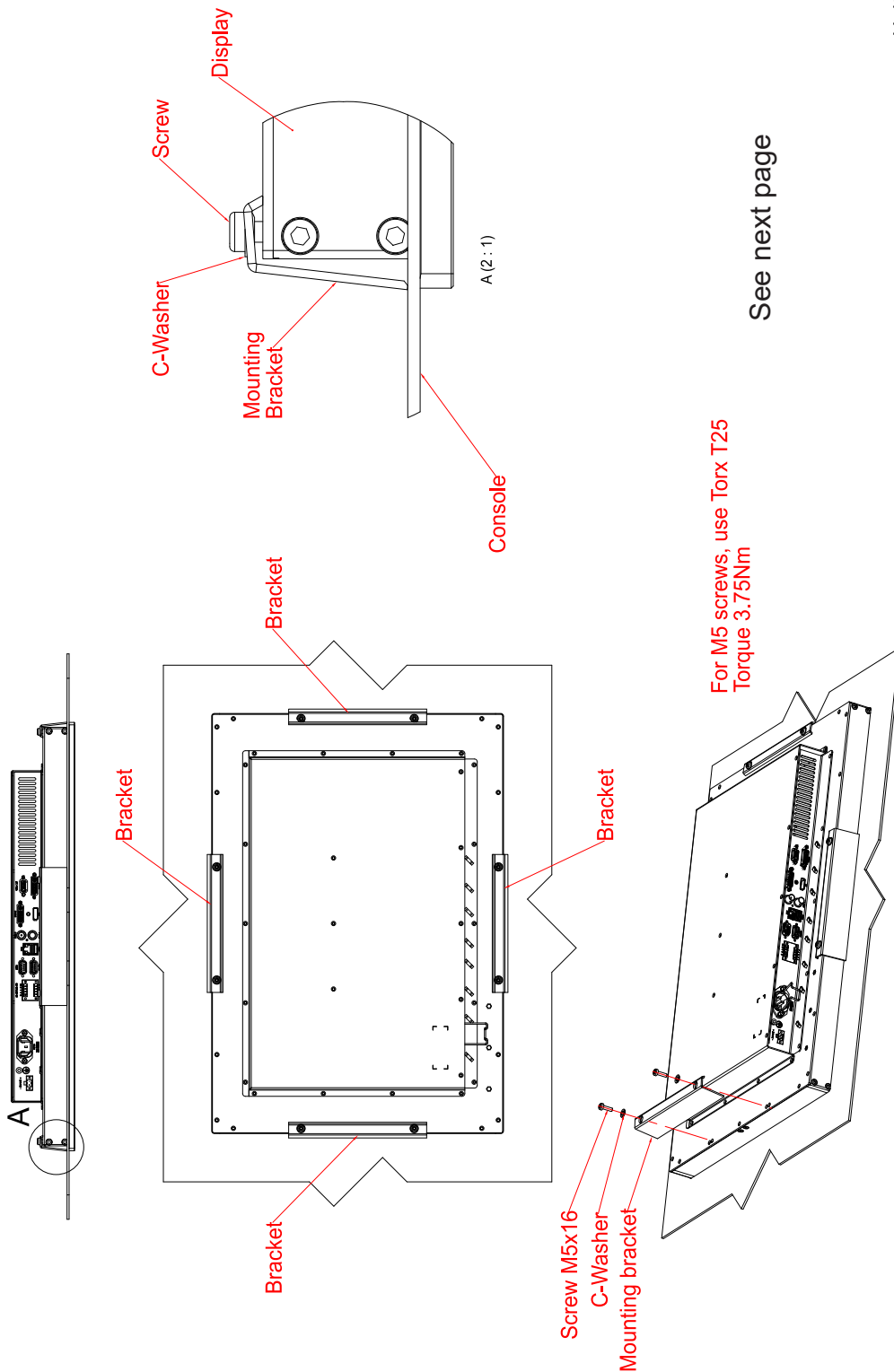

See next page

Units: mm [inches]

Creation date by	15.09.17	df35	Preparation	A1
Last rev. date by	/	/	Scale	1:5
Hatteland Technology AS			Material	HATTELAND TECHNOLOGY
Eikestrøgevegen 52			Approved by	
N-5570 Ålesund			Revision	1
			Drawing number	A010698

SALES DRAWING HD CMB SX2-F1 (Console Mount Kit)
 Drawing shows HD 26T22 MMD - Series X Generation 2 (G2) model, but same procedure also applies for HD 26T22 MxC - Maritime Multi Computers (MMC) models.

This document is the property of Hatteland Technology AS. This document and any authorized reproduction thereof, must not be used in any way against the interest of Hatteland Technology AS. Any authorized reproduction, in whole or in part, must include this legend. Hatteland Technology AS Proprietary information. Not to be distributed to any third party without written permission.

Technical Drawings - HD CMB SX2-F1

Dimensions might be shown with or without decimals and indicated as mm [inches]. Tolerance on drawings is +/- 1mm. For accurate measurements, check relevant DWG file.

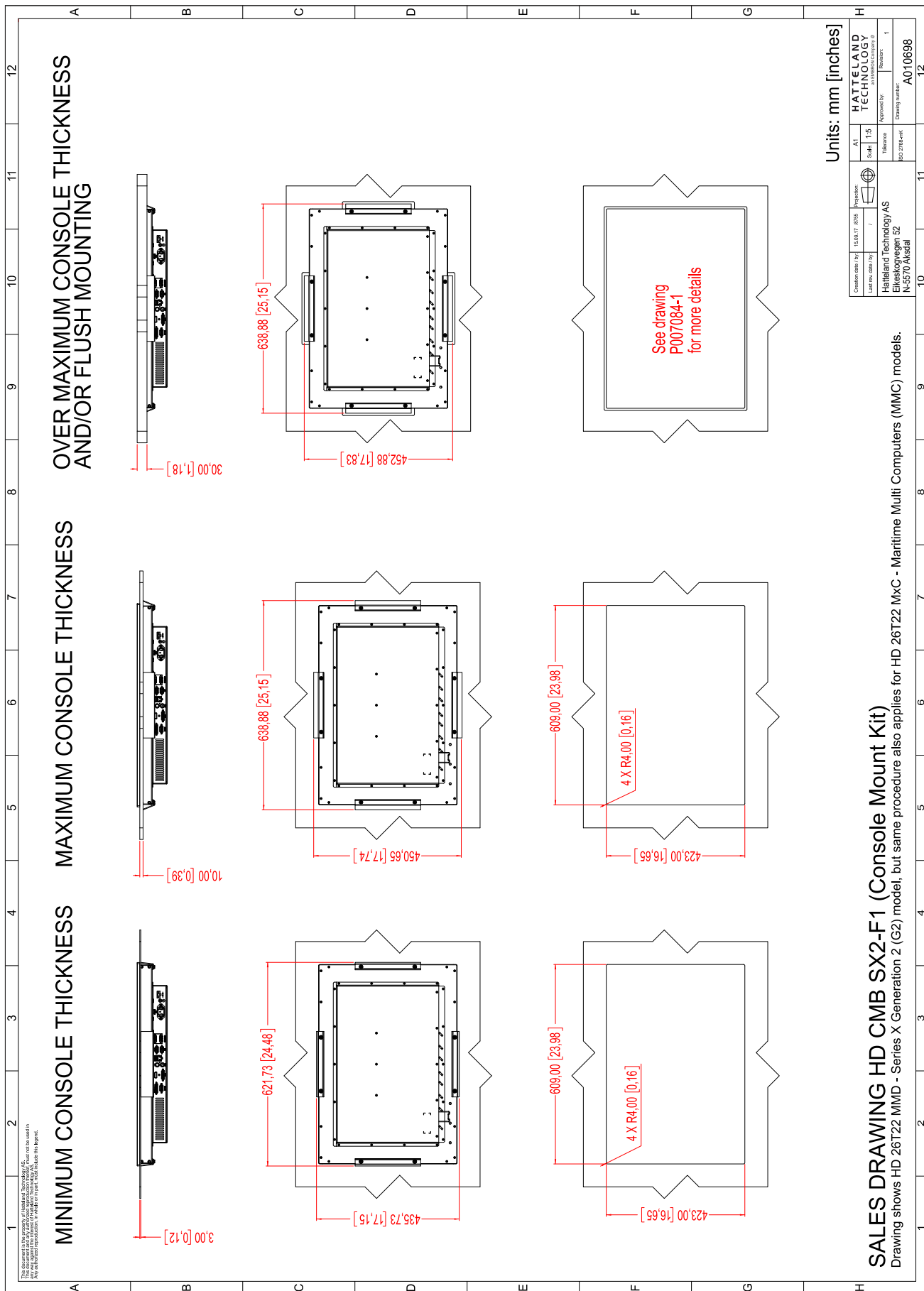

SALES DRAWING HD CMB SX2-F1 (Console Mount Kit)

Drawing shows HD 26T22 MMD - Series X Generation 2 (G2) model, but same procedure also applies for HD 26T22 MxC - Maritime Multi Computers (MMC) models.

This document is the property of Hatteland Technology AS. This document and any authorized reproduction thereof, must not be used in any way against the interest of Hatteland Technology AS. Any authorized reproduction, in whole or in part, must include this legend. Hatteland Technology AS Proprietary information. Not to be distributed to any third party without written permission.

Technical Drawings - HD CMB SX2-F1

Dimensions might be shown with or without decimals and indicated as mm [inches]. Tolerance on drawings is +/- 1mm. For accurate measurements, check relevant DWG file.

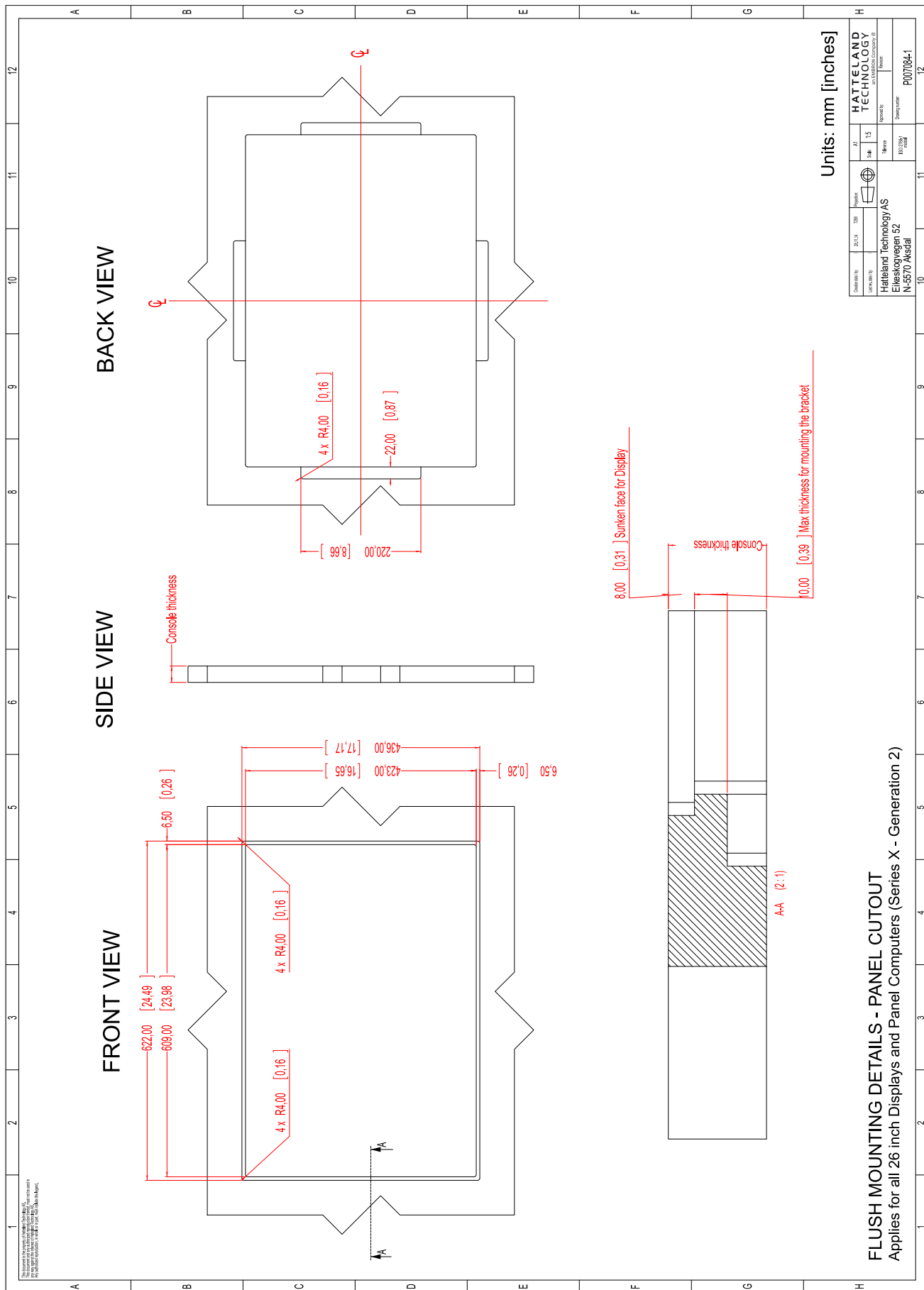

This document is the property of Hatteland Technology AS. This document and any authorized reproduction thereof, must not be used in any way against the interest of Hatteland Technology AS. Any authorized reproduction, in whole or in part, must include this legend. Hatteland Technology AS Proprietary information. Not to be distributed to any third party without written permission.

P007084-1 Flush Mounting 26 inch 123

Dimensions might be shown with or without decimals and indicated as mm [inches]. Tolerance on drawings is +/- 1mm. For accurate measurements, check relevant DWG file.

BRACKET INSTRUCTIONS

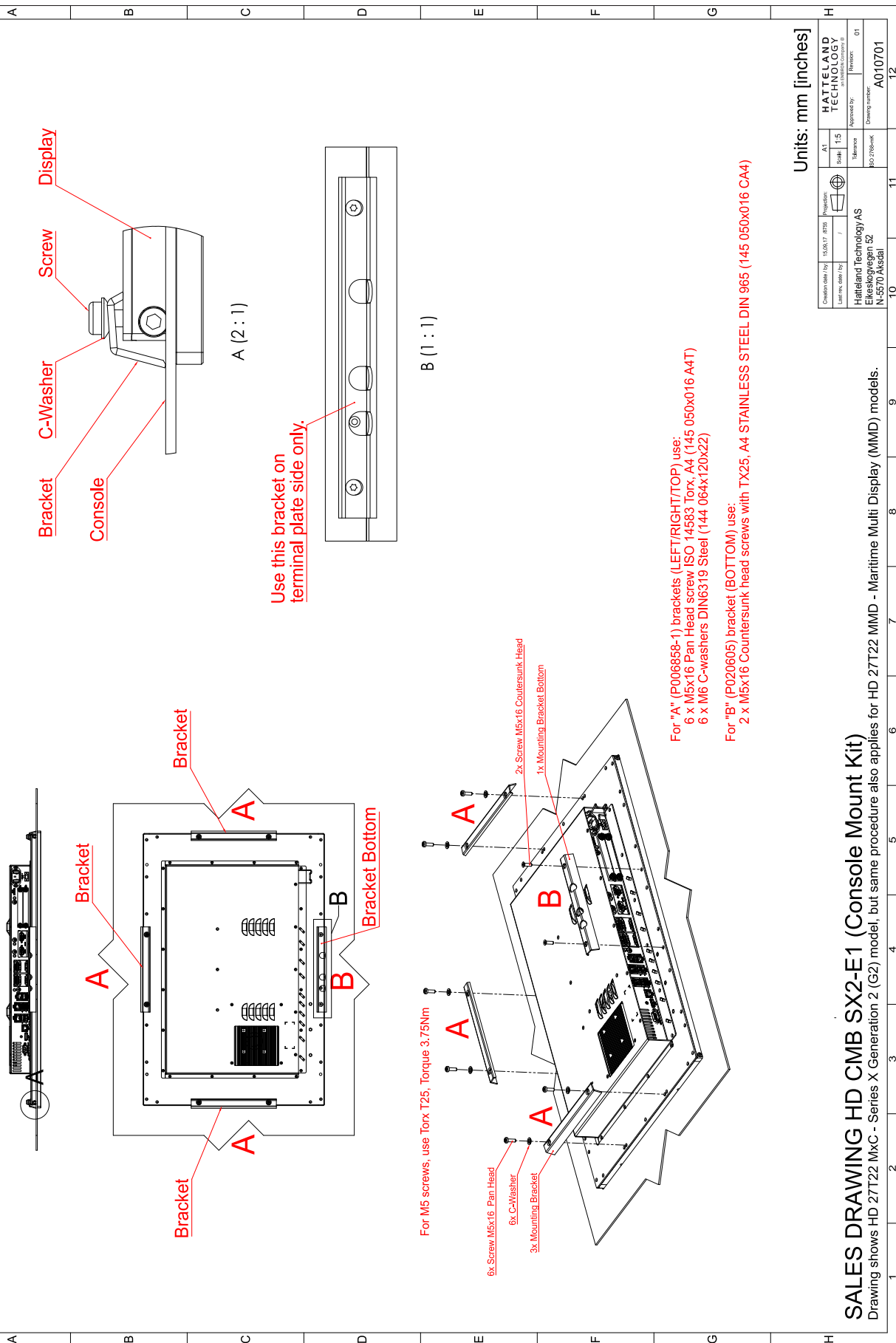

SALES DRAWING HD CMB SX2-E1 (Console Mount Kit)

Drawing shows HD 27T22 MxC - Series X Generation 2 (G2) model, but same procedure also applies for HD 27T22 MMD - Maritime Multi Display (MMD) models.

This document is the property of Hatteland Technology AS. This document and any authorized reproduction thereof, must not be used in any way against the interest of Hatteland Technology AS. Any authorized reproduction, in whole or in part, must include this legend. Hatteland Technology AS Proprietary information. Not to be distributed to any third party without written permission.

Technical Drawings - HD CMB SX2-E1

Dimensions might be shown with or without decimals and indicated as mm [inches]. Tolerance on drawings is +/- 1mm. For accurate measurements, check relevant DWG file.

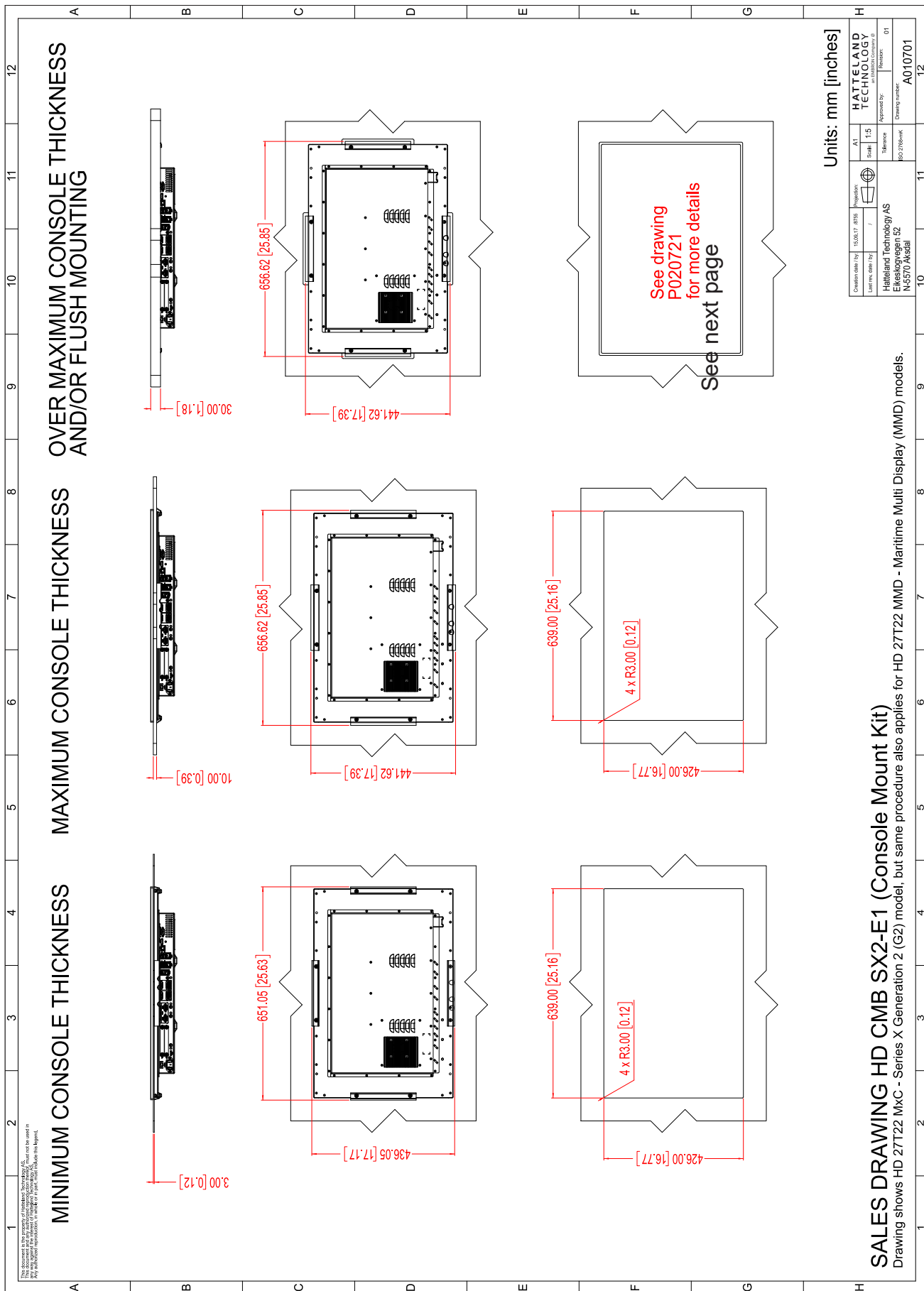

SALES DRAWING HD CMB SX2-E1 (Console Mount Kit)

Drawing shows HD 27T22 MxC - Series X Generation 2 (G2) model, but same procedure also applies for HD 27T22 MMD - Maritime Multi Display (MMD) models.

This document is the property of Hatteland Technology AS. This document and any authorized reproduction thereof, must not be used in any way against the interest of Hatteland Technology AS. Any authorized reproduction, in whole or in part, must include this legend. Hatteland Technology AS Proprietary information. Not to be distributed to any third party without written permission.

Technical Drawings - HD CMB SX2-E1

Dimensions might be shown with or without decimals and indicated as mm [inches]. Tolerance on drawings is +/- 1mm. For accurate measurements, check relevant DWG file.

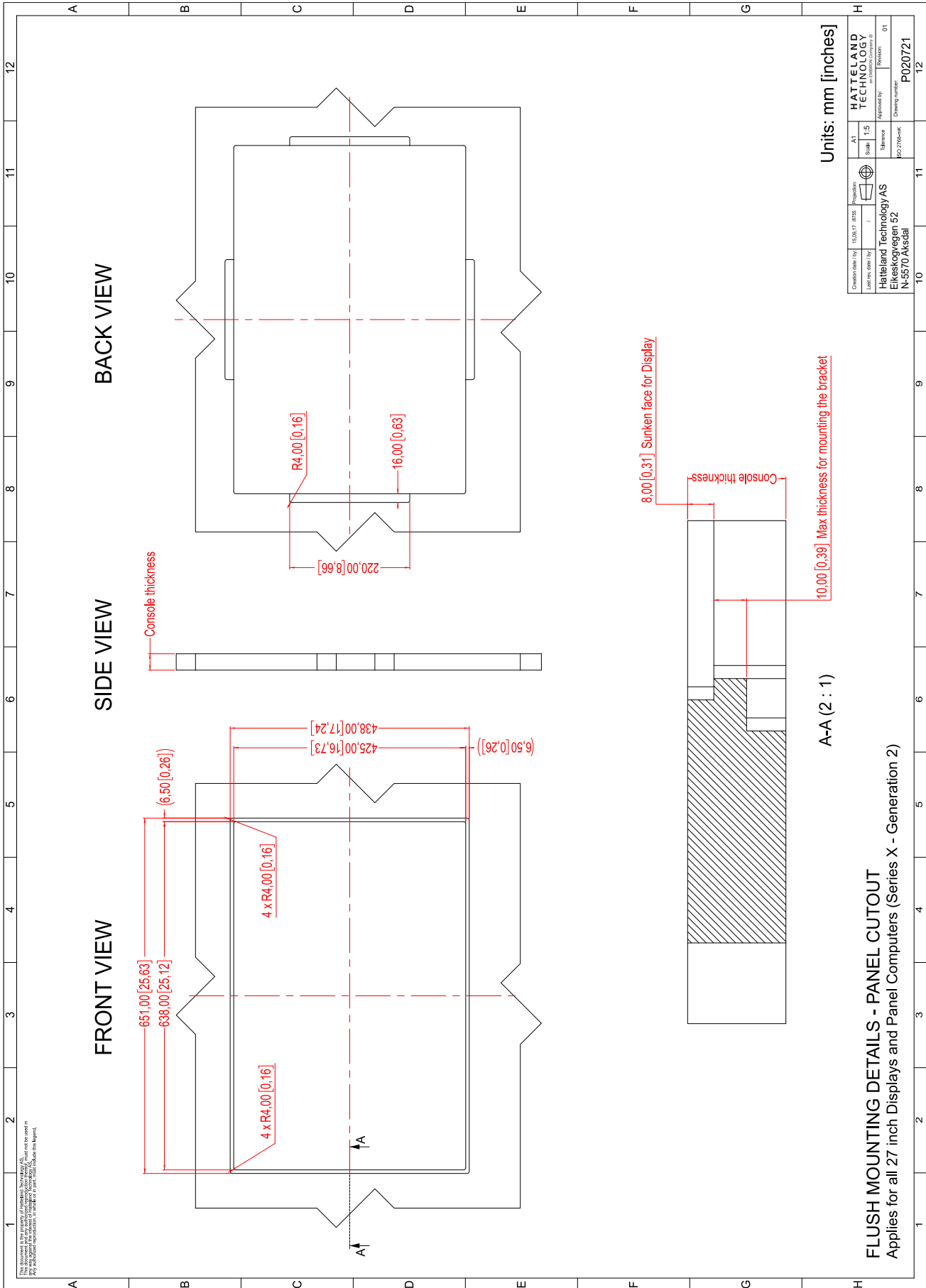

This document is the property of Hatteland Technology AS. This document and any authorized reproduction thereof, must not be used in any way against the interest of Hatteland Technology AS. Any authorized reproduction, in whole or in part, must include this legend. Hatteland Technology AS Proprietary information. Not to be distributed to any third party without written permission.

Technical Drawings - HD VED SX2-A1

Dimensions might be shown with or without decimals and indicated as mm [inches]. Tolerance on drawings is +/- 1mm. For accurate measurements, check relevant DWG file.

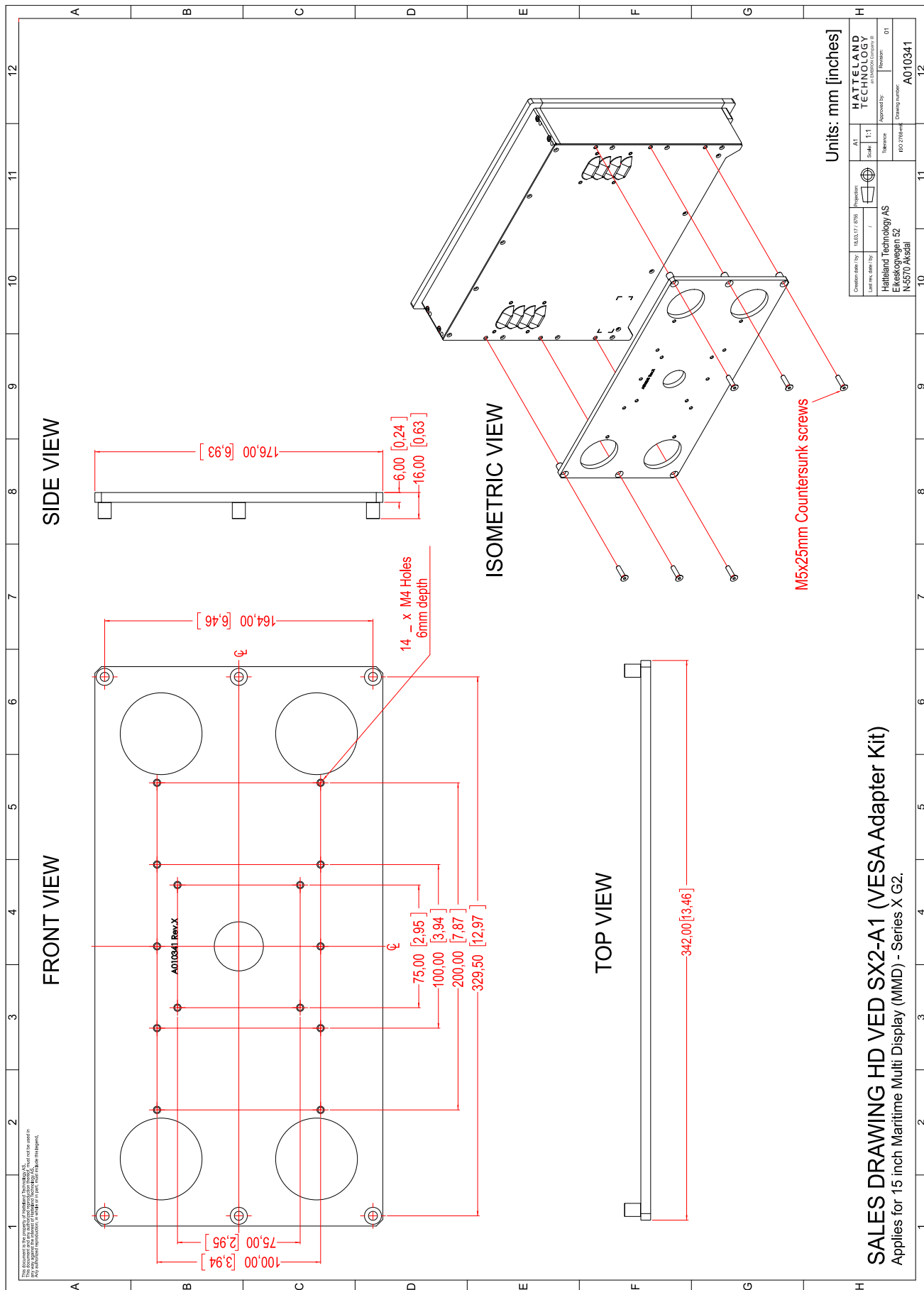

This document is the property of Hatteland Technology AS. This document and any authorized reproduction thereof, must not be used in any way against the interest of Hatteland Technology AS. Any authorized reproduction, in whole or in part, must include this legend. Hatteland Technology AS Proprietary information. Not to be distributed to any third party without written permission.

Technical Drawings - HD VED SX2-B1

Dimensions might be shown with or without decimals and indicated as mm [inches]. Tolerance on drawings is +/- 1mm. For accurate measurements, check relevant DWG file.

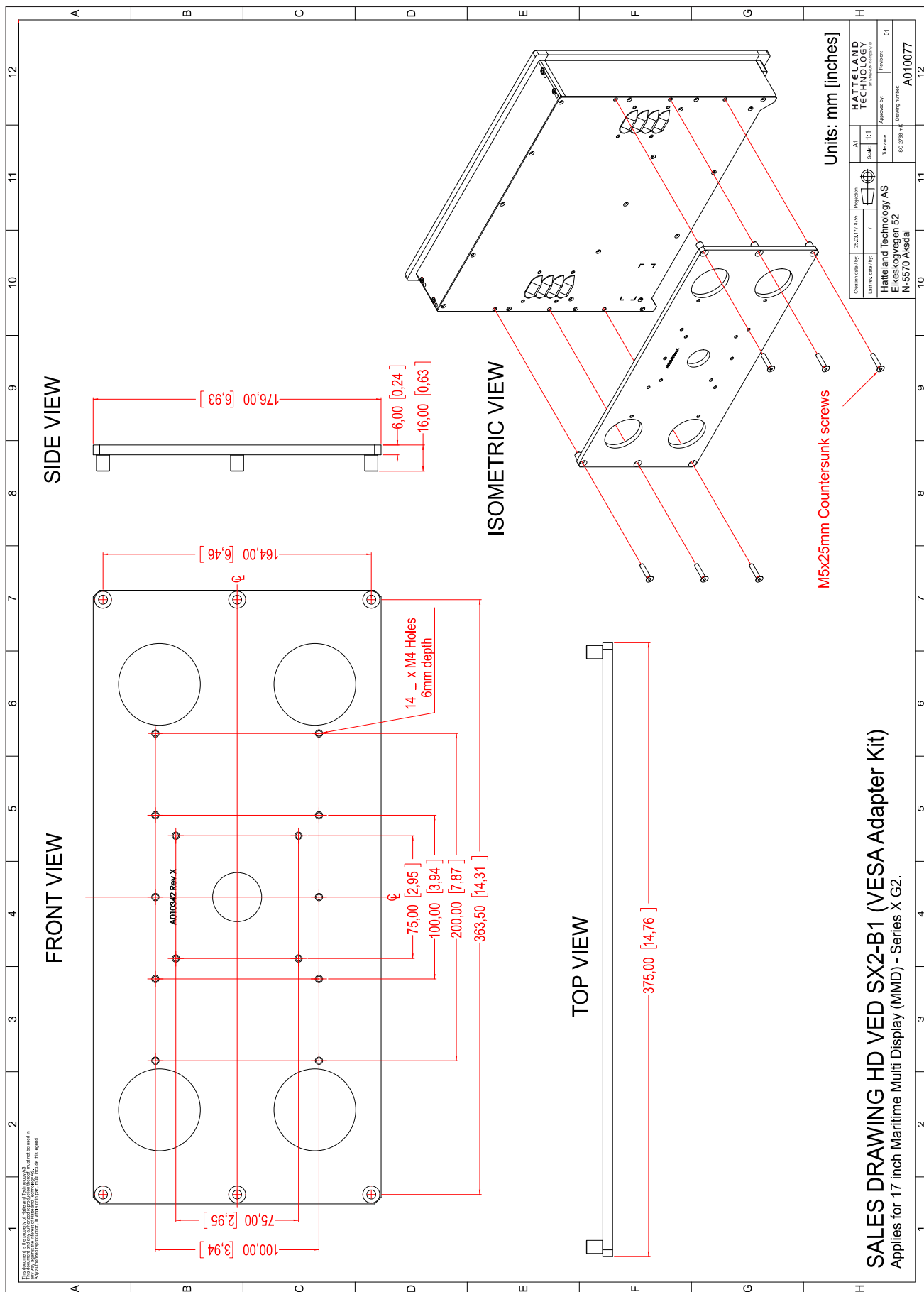

This document is the property of Hatteland Technology AS. This document and any authorized reproduction thereof, must not be used in any way against the interest of Hatteland Technology AS. Any authorized reproduction, in whole or in part, must include this legend. Hatteland Technology AS Proprietary information. Not to be distributed to any third party without written permission.

Technical Drawings - HD VED SX2-C1

Dimensions might be shown with or without decimals and indicated as mm [inches]. Tolerance on drawings is +/- 1mm. For accurate measurements, check relevant DWG file.

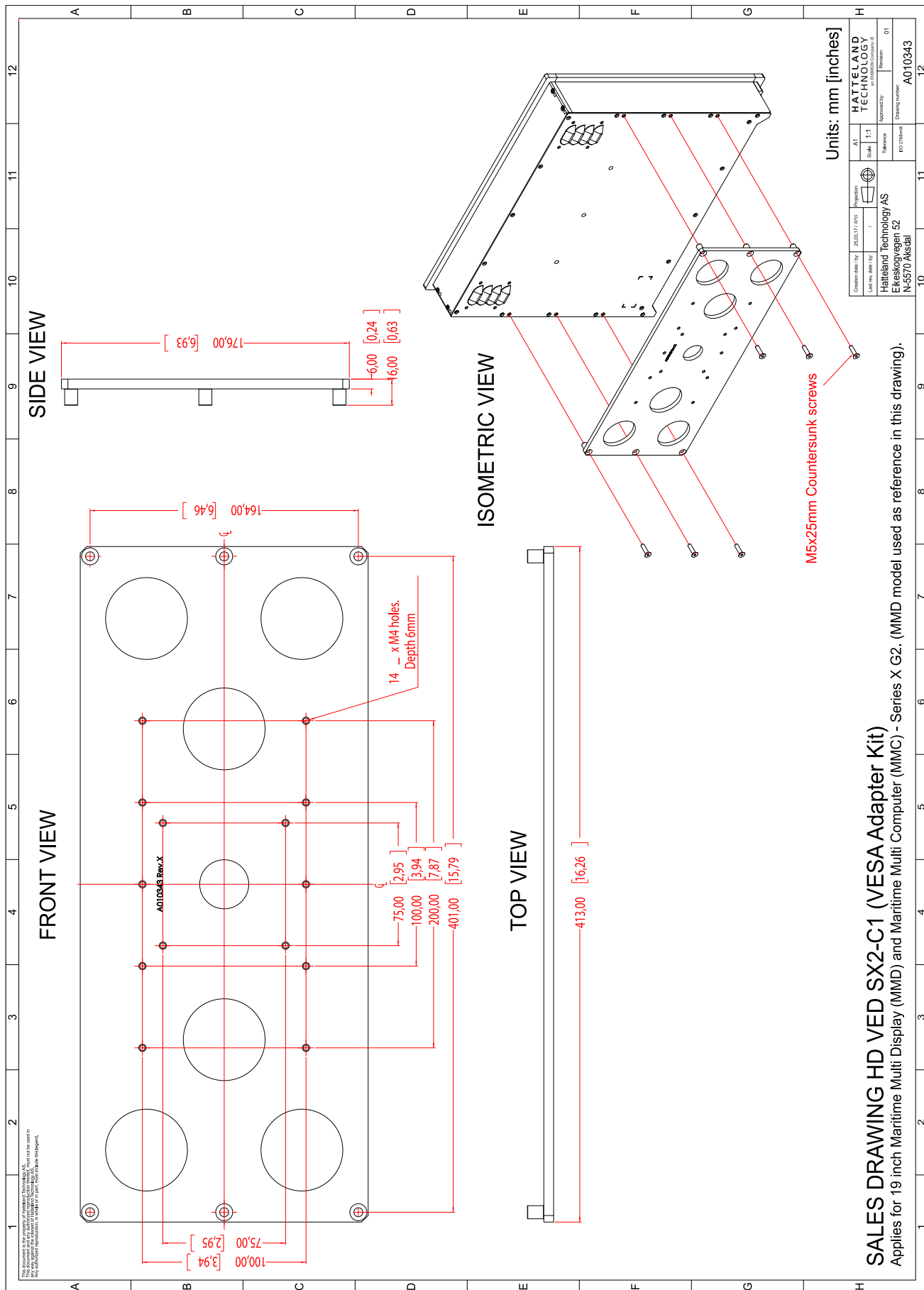

Technical Drawings - HD VED SX2-I1

Dimensions might be shown with or without decimals and indicated as mm [inches]. Tolerance on drawings is +/- 1mm. For accurate measurements, check relevant DWG file.

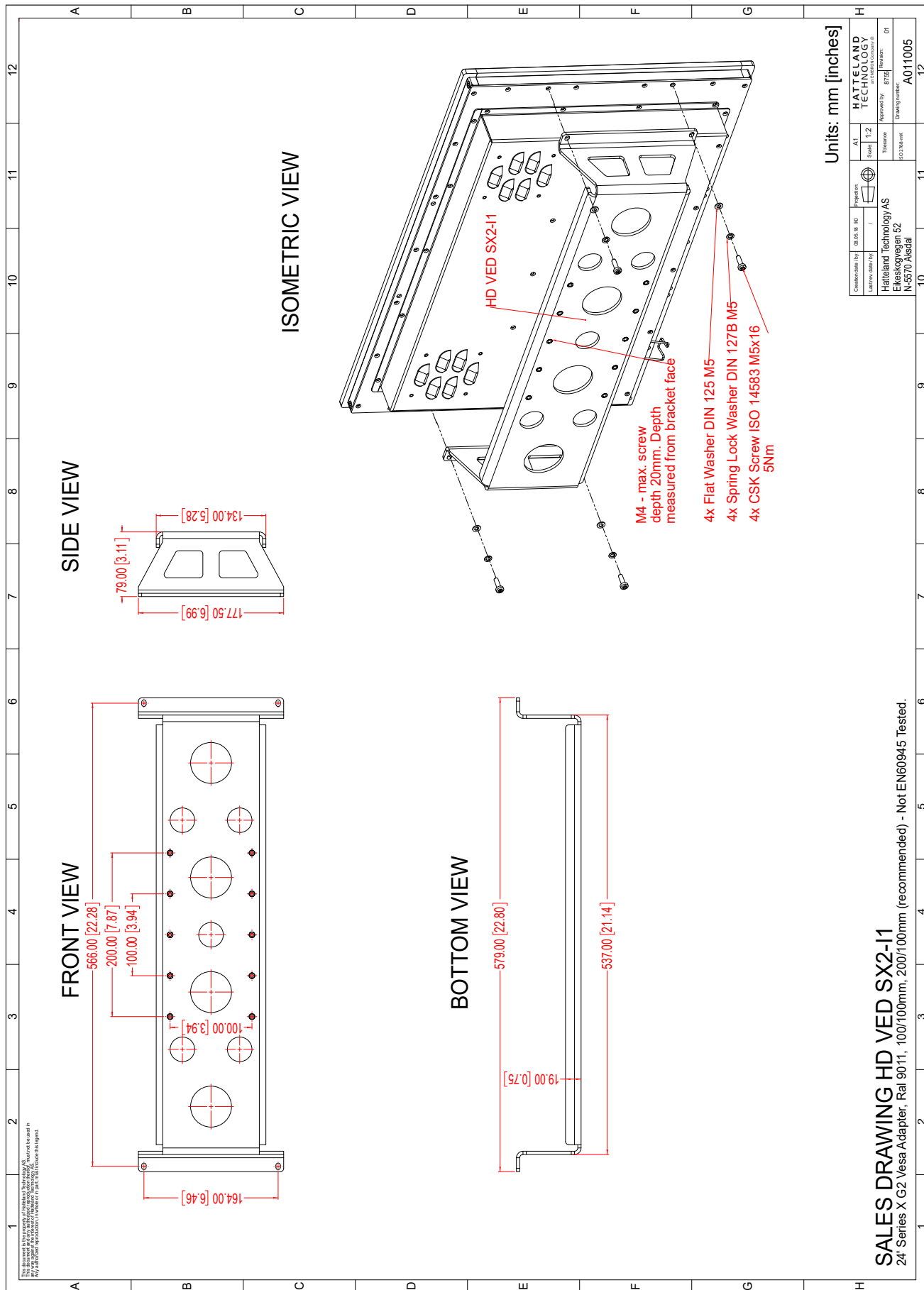

SALES DRAWING HD VED SX2-I1

24" Series X G2 Vesa Adapter, Ral 9011, 100/100mm, 200/100mm (recommended) - Not EN60945 Tested.

This document is the property of Hatteland Technology AS. This document and any authorized reproduction thereof, must not be used in any way against the interest of Hatteland Technology AS. Any authorized reproduction, in whole or in part, must include this legend. Hatteland Technology AS Proprietary information. Not to be distributed to any third party without written permission.

Technical Drawings - HD VED SX2-J1

Dimensions might be shown with or without decimals and indicated as mm [inches]. Tolerance on drawings is +/- 1mm. For accurate measurements, check relevant DWG file.

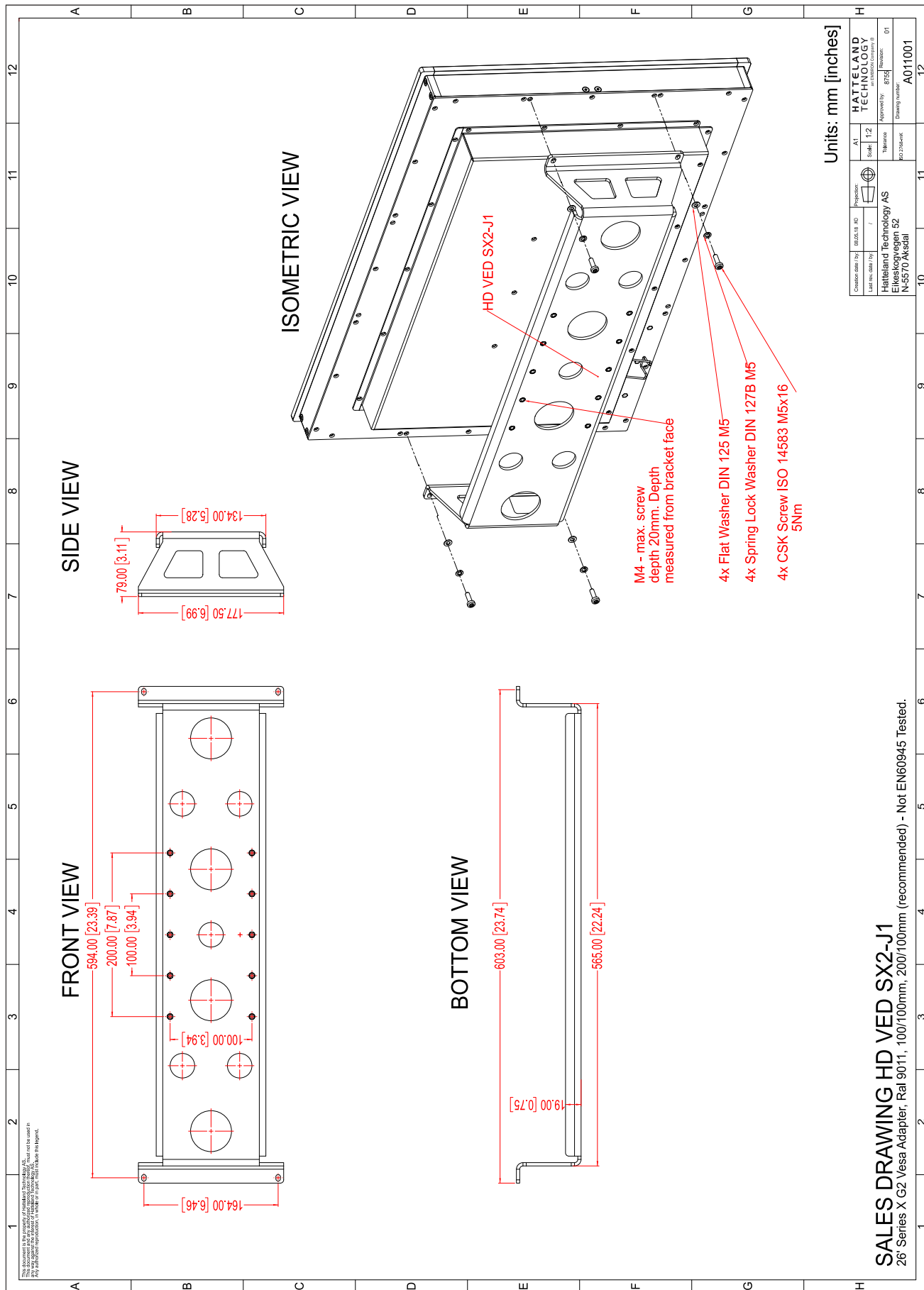

SALES DRAWING HD VED SX2-J1

26 Series X G2 Vesa Adapter, Ral 9011, 100/100mm, 200/100mm (recommended) - Not EN60945 Tested.

This document is the property of Hatteland Technology AS. This document and any authorized reproduction thereof, must not be used in any way against the interest of Hatteland Technology AS. Any authorized reproduction, in whole or in part, must include this legend. Hatteland Technology AS Proprietary information. Not to be distributed to any third party without written permission.

Technical Drawings - JH 15TAP STD-C1

Dimensions might be shown with or without decimals and indicated as mm [inches]. Tolerance on drawings is +/- 1mm. For accurate measurements, check relevant DWG file.

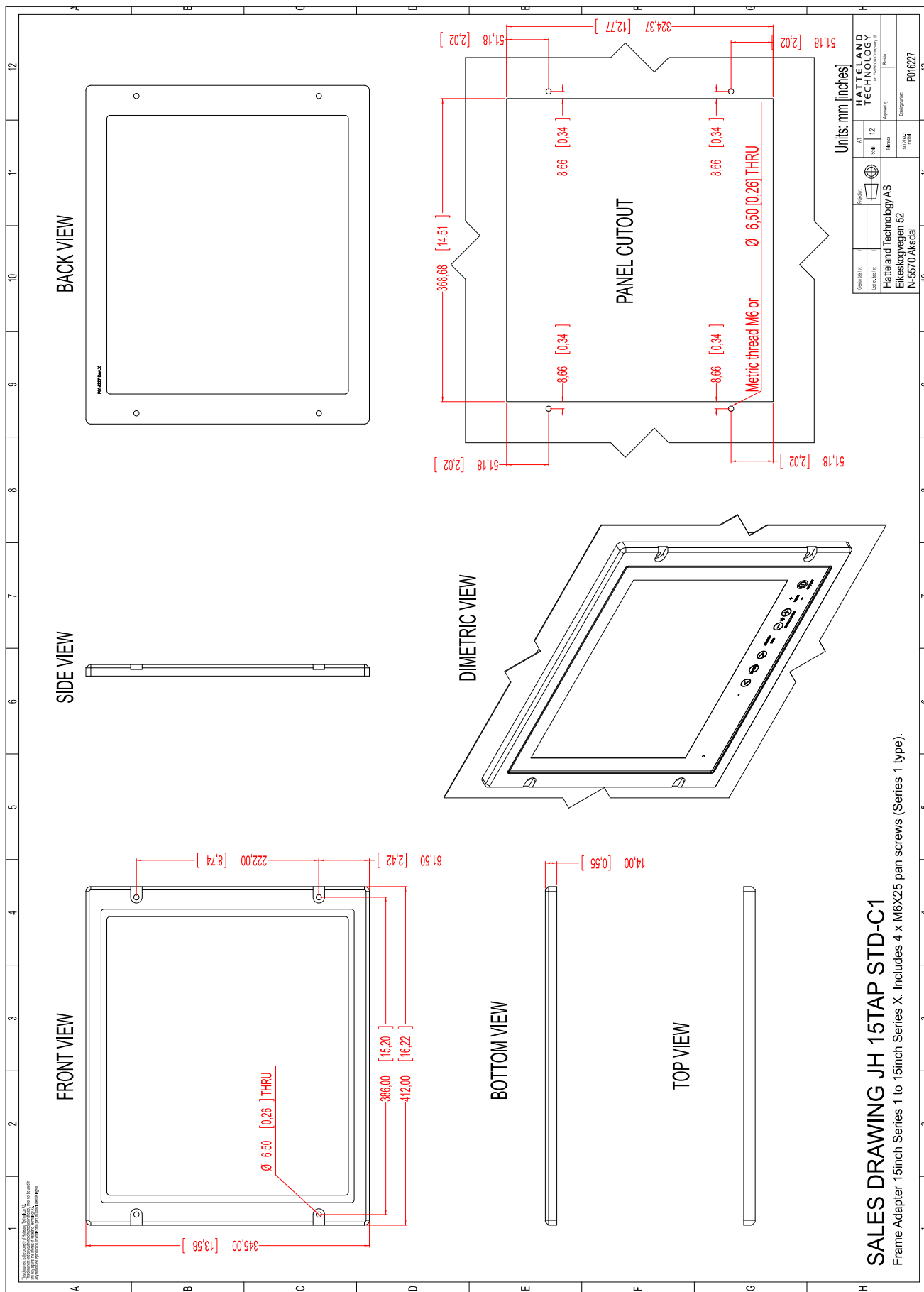

SALES DRAWING JH 15TAP STD-C1
 Frame Adapter 15inch Series 1 to 15inch Series X. Includes 4 x M6X25 pan screws (Series 1 type).

This document is the property of Hatteland Technology AS. This document and any authorized reproduction thereof, must not be used in any way against the interest of Hatteland Technology AS. Any authorized reproduction, in whole or in part, must include this legend. Hatteland Technology AS Proprietary information. Not to be distributed to any third party without written permission.

Technical Drawings - HD 19TAP SX2-C2

Dimensions might be shown with or without decimals and indicated as mm [inches]. Tolerance on drawings is +/- 1mm. For accurate measurements, check relevant DWG file.

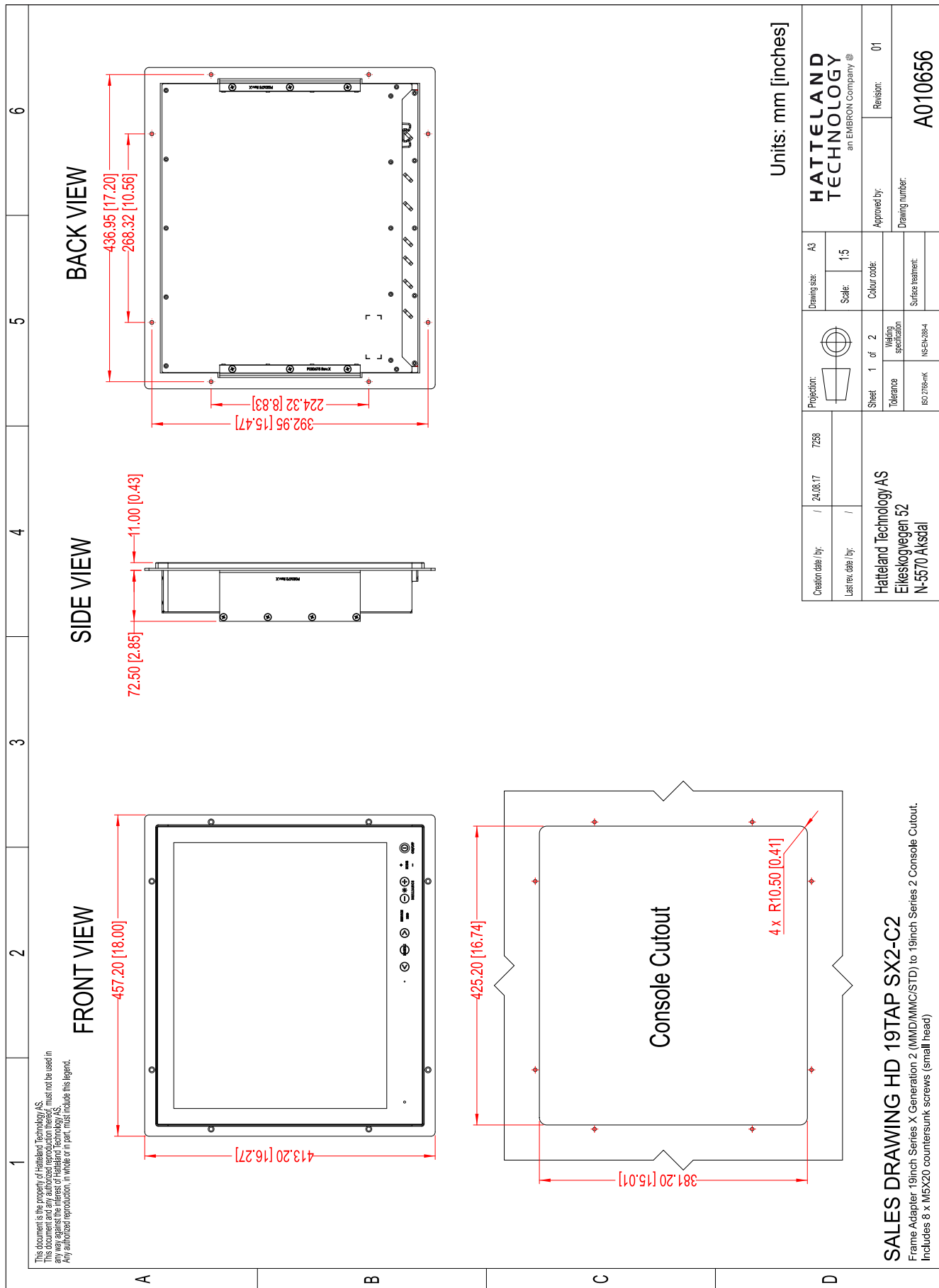

SALES DRAWING HD 19TAP SX2-C2
 Frame Adapter, 19inch Series X Generation 2 (MMD/MMC/STD) to 19inch Series 2 Console Cutout.
 Includes 8 x M5x20 countersunk screws (small head)

This document is the property of Hatteland Technology AS. This document and any authorized reproduction thereof, must not be used in any way against the interest of Hatteland Technology AS. Any authorized reproduction, in whole or in part, must include this legend. Hatteland Technology AS Proprietary information. Not to be distributed to any third party without written permission.

Technical Drawings - HD 19TAP SX2-C2

Dimensions might be shown with or without decimals and indicated as +/- 1mm. For accurate measurements, check relevant DWG file.

1
2
3
4
5
6

A
B
C
D

ItemNo	Quantity	Description
1	1	Console adapter plate 19T03 to 19T22
2	2	HD TAP SX2-x1 Foot
3	8	ISO 7046-1 - M5 x 16
4	1	HD 19T22 MMD
5	6	ISO 7046-1 - M5 x 20
6	1	Panel Cut Out HD19T03-F
7	8	SNFS M5x20 Countersunk Small Head Screws

Creation date: / / 24.08.17	7238	Projection: A3	Drawing size: A3	HATTELAND TECHNOLOGY an EMERSON Company ®
Last rev. date: / /			Scale: 1:5	Approved by: _____
Hatteland Technology AS		Sheet 2 of 2	Colour code: _____	Revision: 01
Elkeskogvegen 52		Tolerance _____	Welding specification _____	Drawing number: _____
N-5570 Akksdal		ISO 2768-mK	Surface treatment: _____	A010656

SALES DRAWING HD 19TAP SX2-C2

Frame Adapter 19inch Series X Generation 2 (MMD/MMC/STD) to 19inch Series 2 Console Cutout.
Includes 8 x M5X20 countersunk screws (small head)

This document is the property of Hatteland Technology AS. This document and any authorized reproduction thereof, must not be used in any way against the interest of Hatteland Technology AS. Any authorized reproduction, in whole or in part, must include this legend. Hatteland Technology AS Proprietary information. Not to be distributed to any third party without written permission.

Technical Drawings - JH 26TAP STD-A1

Dimensions might be shown with or without decimals and indicated as mm [inches]. Tolerance on drawings is +/- 1mm. For accurate measurements, check relevant DWG file.

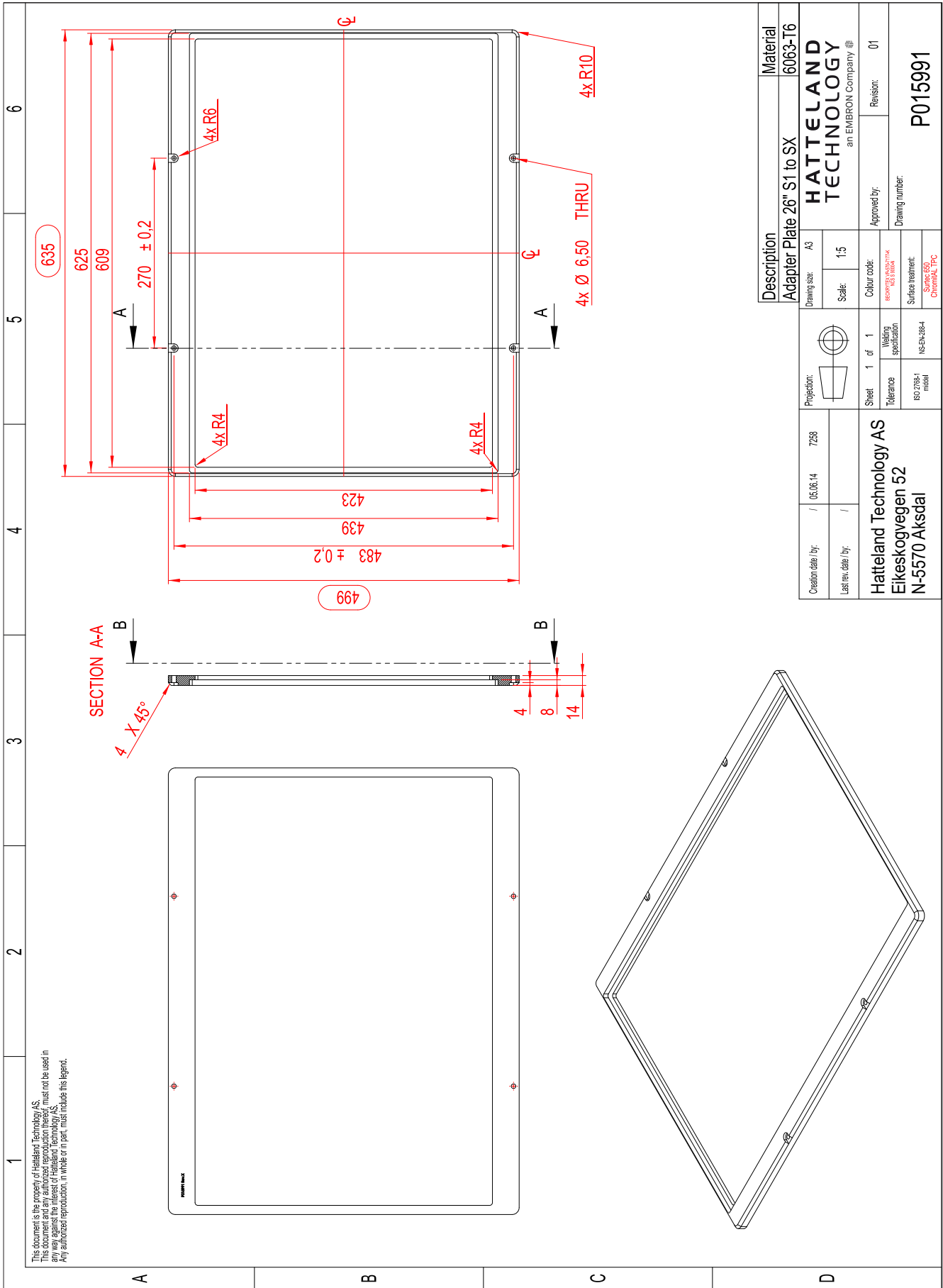

Description		Material	
Adapter Plate 26" S1 to SX		6063-T6	
Drawing size:	A3	HATTELAND TECHNOLOGY an EMBRON Company ®	
Scale:	1:5		
Projection:		Colour code:	Approved by:
Sheet:	1 of 1	REWORKS AND REWORKS	Revision: 01
Tolerance:	Welding specification	Surface treatment:	Drawing number:
ISO 2768-M	NS-EN-286-4	Surface: 6063 Chromate III, PPC	P015991
Creation date by:	05.06.14 7238	Hatteland Technology AS	
Last rev date by:	/	Eikeskogvegen 52	
		N-5570 Aksdal	

This document is the property of Hatteland Technology AS. This document and any authorized reproduction thereof, must not be used in any way against the interest of Hatteland Technology AS. Any authorized reproduction, in whole or in part, must include this legend. Hatteland Technology AS Proprietary information. Not to be distributed to any third party without written permission.

Technical Drawings - HD 26TAP SX1-A1

Dimensions might be shown with or without decimals and indicated as mm [inches]. Tolerance on drawings is +/- 1mm. For accurate measurements, check relevant DWG file.

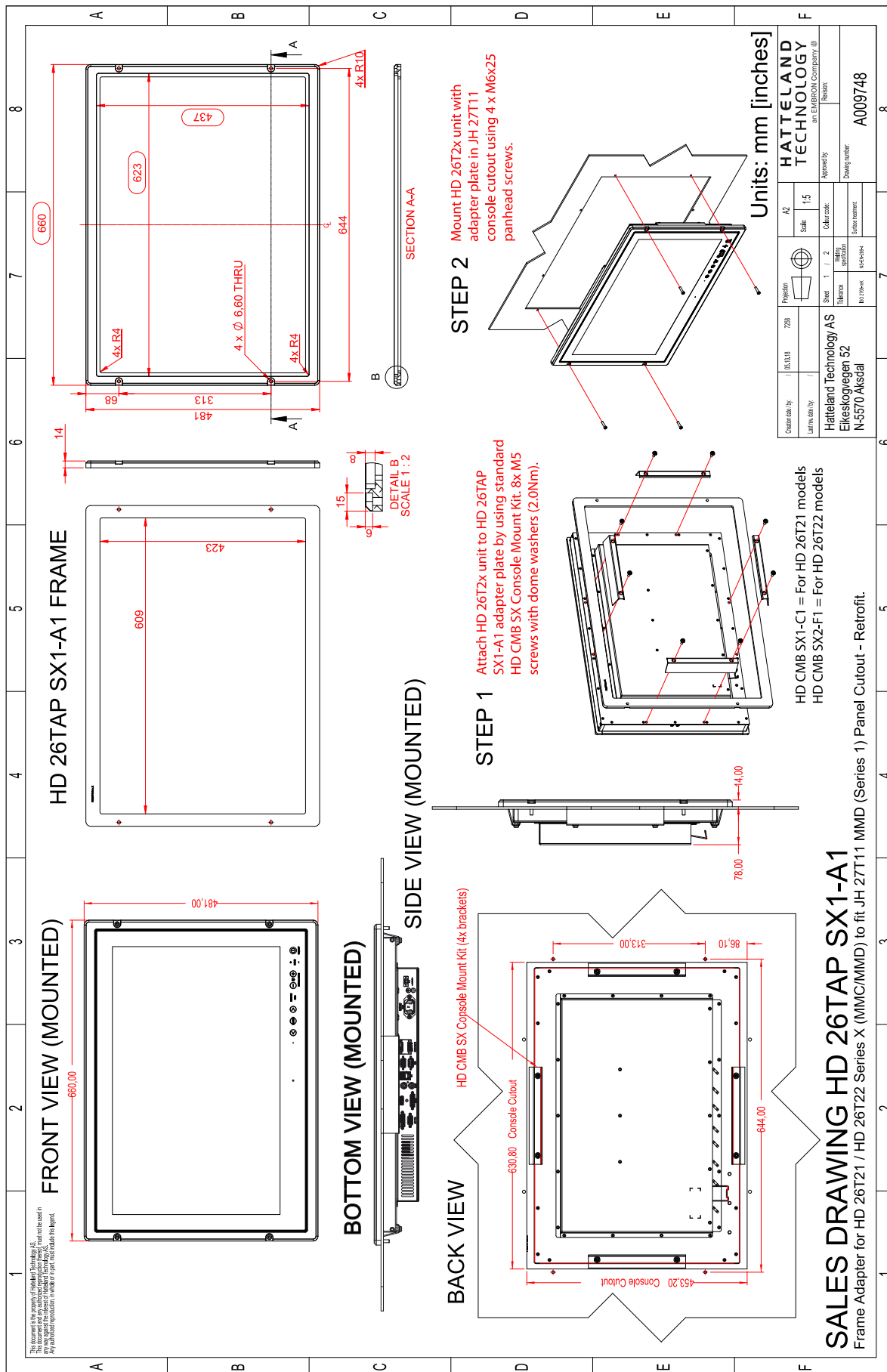

This document is the property of Hatteland Technology AS. This document and any authorized reproduction thereof, must not be used in any way against the interest of Hatteland Technology AS. Any authorized reproduction, in whole or in part, must include this legend. Hatteland Technology AS Proprietary information. Not to be distributed to any third party without written permission.

Dimensions might be shown with or without decimals and indicated as mm [inches]. Tolerance on drawings is +/- 1mm. For accurate measurements, check relevant DWG file.

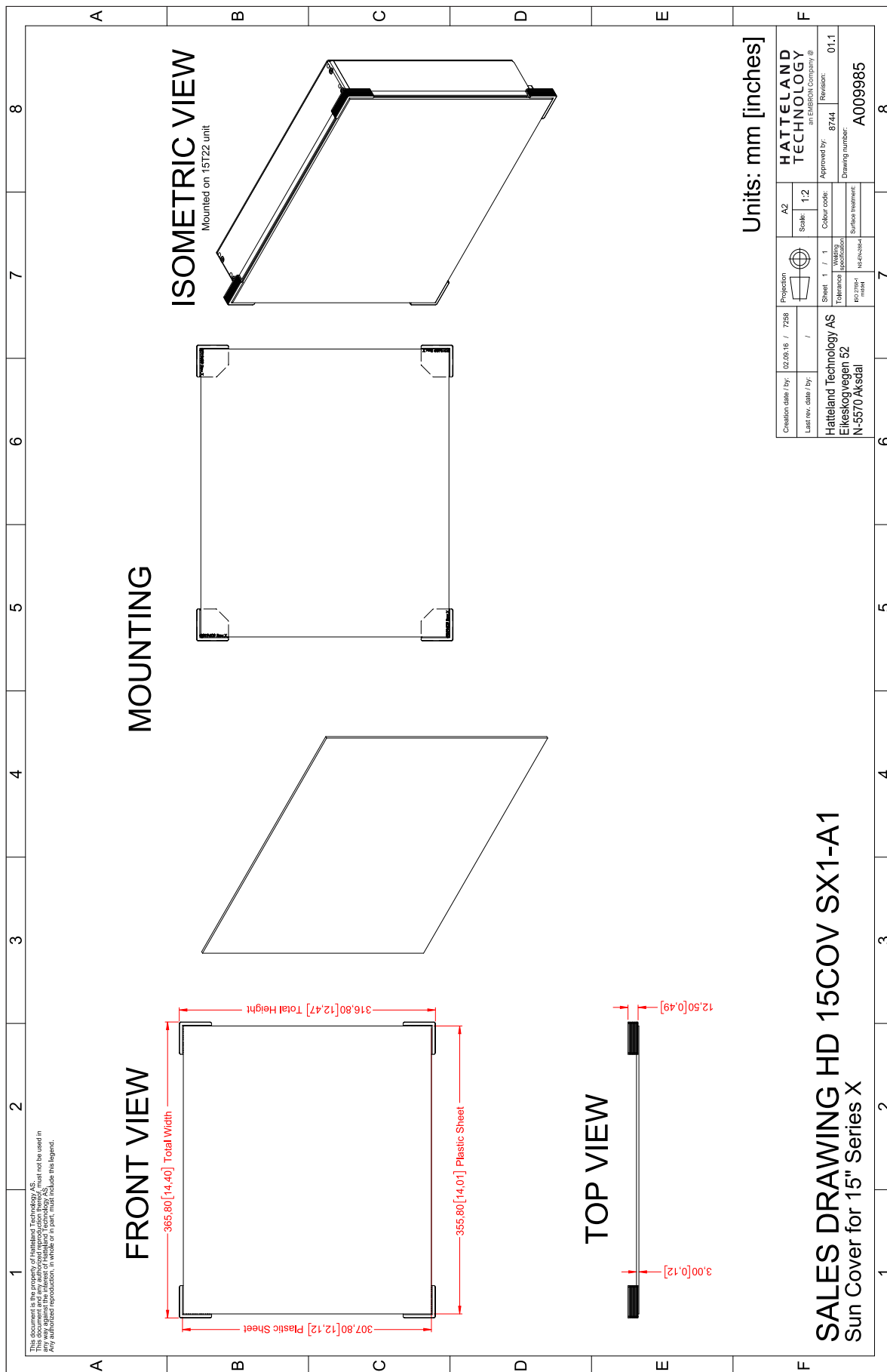

Technical Drawings - HD 17COV SX1-A1

Dimensions might be shown with or without decimals and indicated as mm [inches]. Tolerance on drawings is +/- 1mm. For accurate measurements, check relevant DWG file.

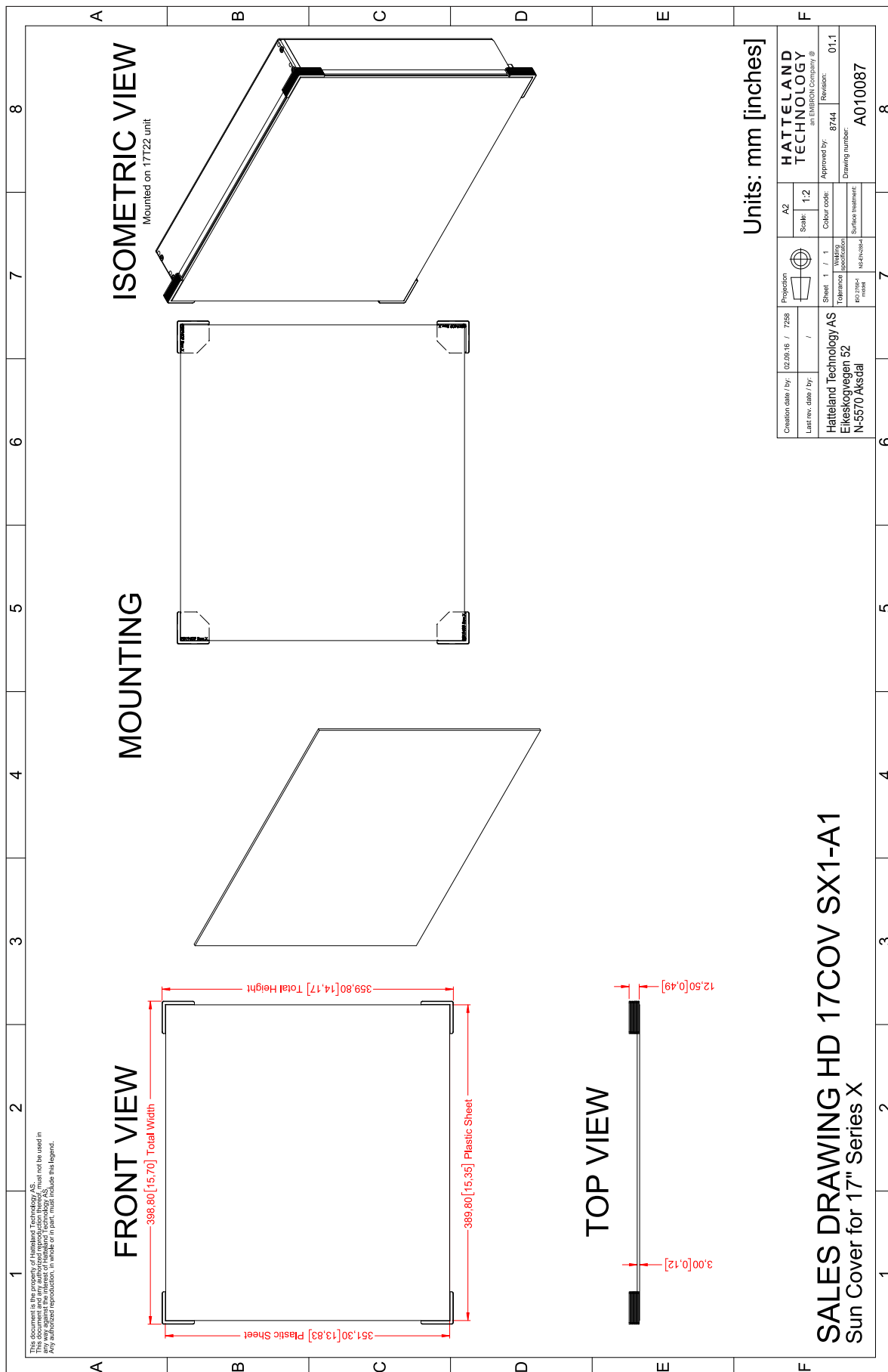

UV Sun Cover (17 inch)

140

This document is the property of Hatteland Technology AS. This document and any authorized reproduction thereof, must not be used in any way against the interest of Hatteland Technology AS. Any authorized reproduction, in whole or in part, must include this legend. Hatteland Technology AS Proprietary information. Not to be distributed to any third party without written permission.

Technical Drawings - HD 19COV SX1-A1

Dimensions might be shown with or without decimals and indicated as mm [inches]. Tolerance on drawings is +/- 1mm. For accurate measurements, check relevant DWG file.

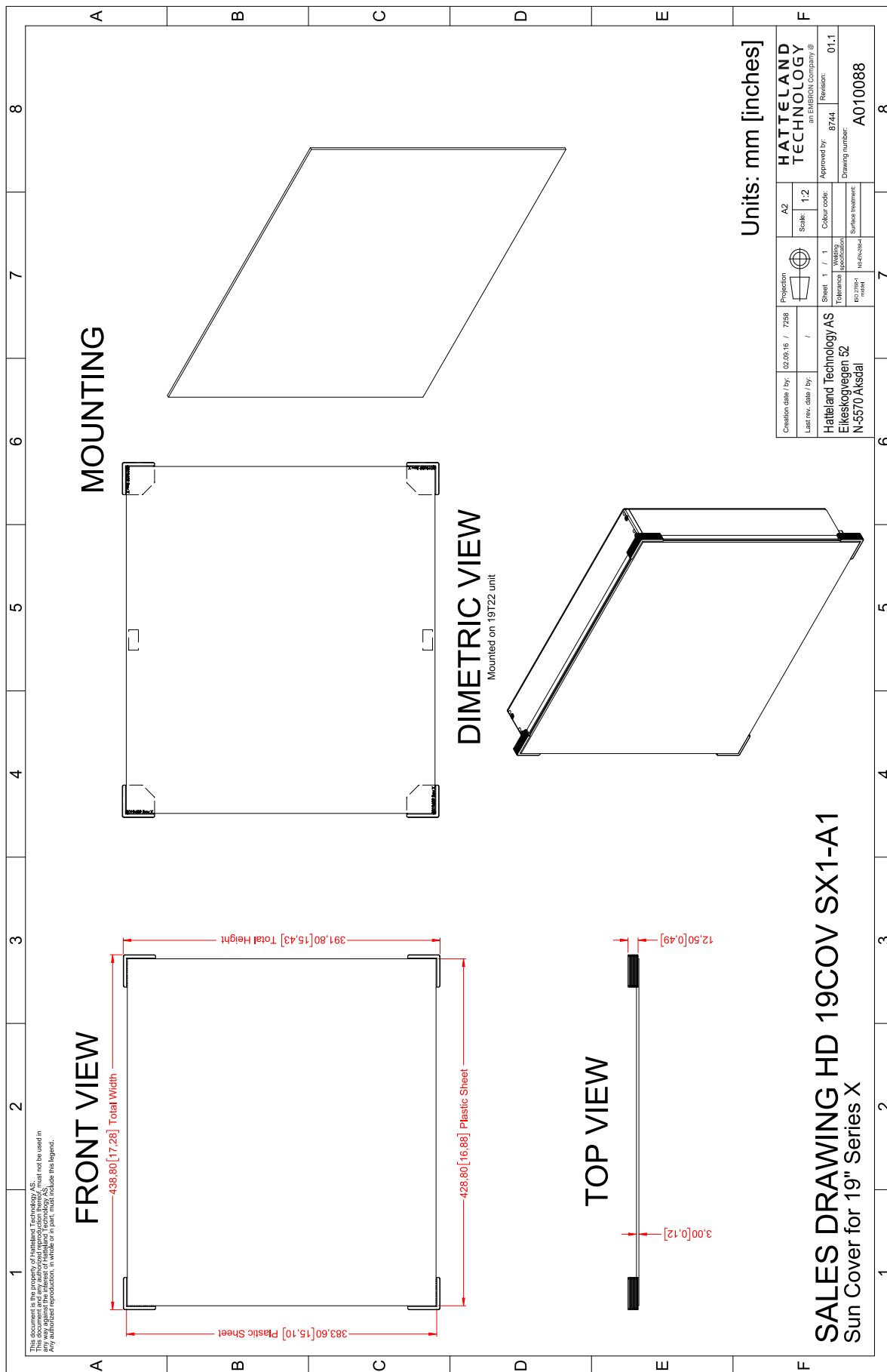

Dimensions might be shown with or without decimals and indicated as mm [inches]. Tolerance on drawings is +/- 1mm. For accurate measurements, check relevant DWG file.

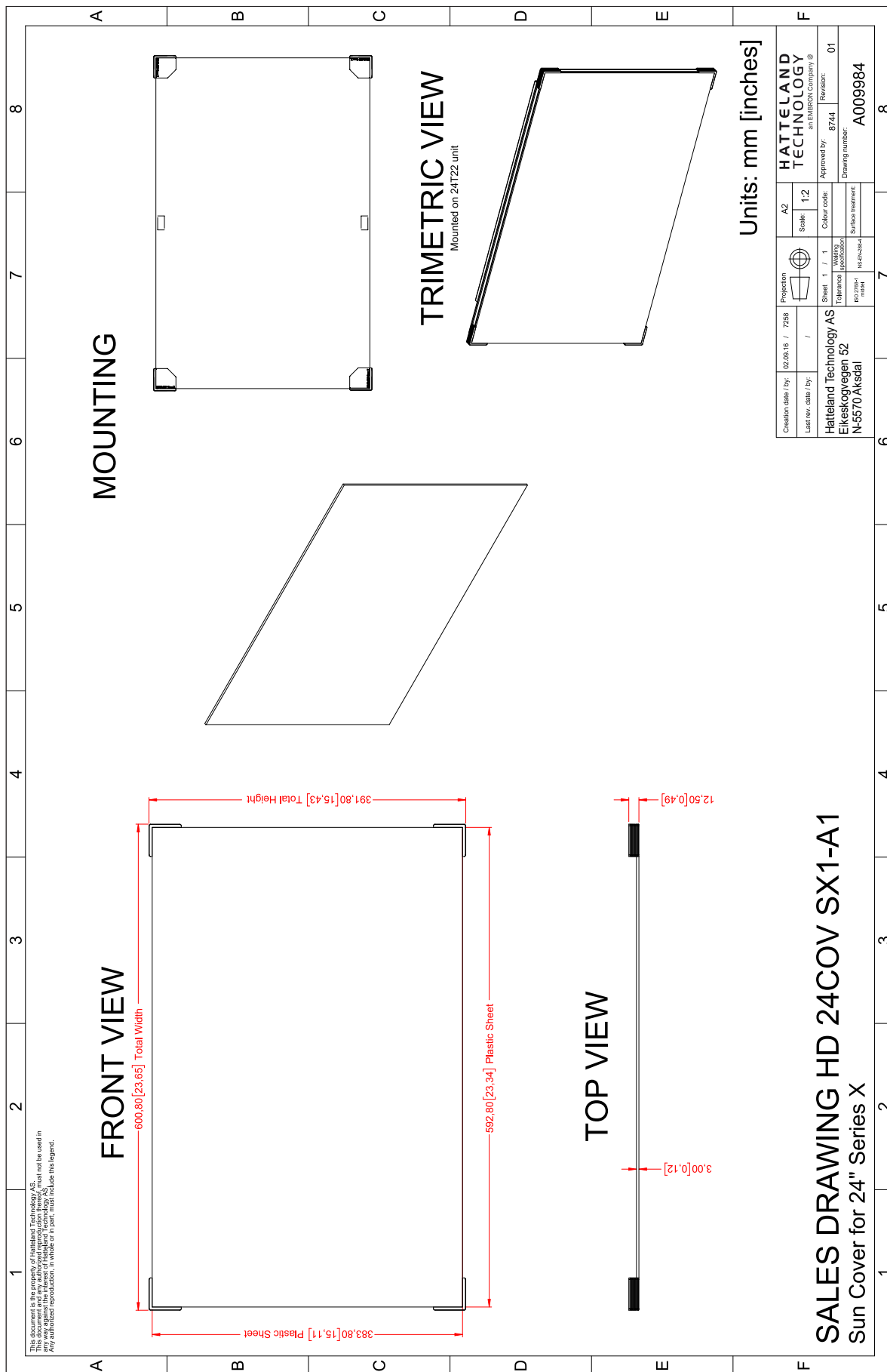

Dimensions might be shown with or without decimals and indicated as mm [inches]. Tolerance on drawings is +/- 1mm. For accurate measurements, check relevant DWG file.

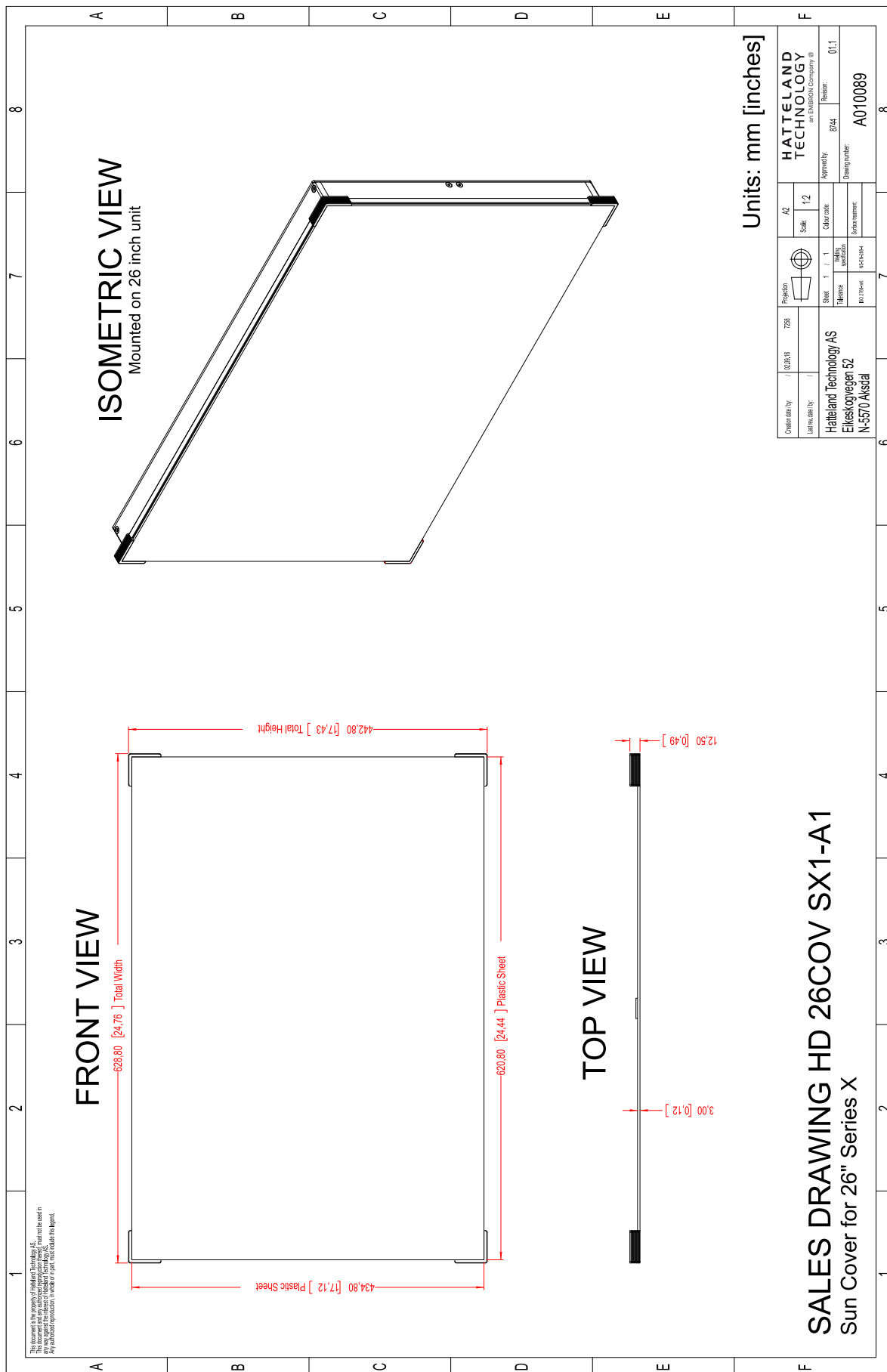

Units: mm [inches]

Order date by	02/26/16	7258	Project	A2
Let's see by			Scale	1:2
			Sheet	1 / 1
			Other code	
			Tolerance	
			Material	
			Surface treatment	
			ISO 7183	
			ISO 10361	
			ISO 10362	
			ISO 10363	
			ISO 10364	
			ISO 10365	
			ISO 10366	
			ISO 10367	
			ISO 10368	
			ISO 10369	
			ISO 10370	
			ISO 10371	
			ISO 10372	
			ISO 10373	
			ISO 10374	
			ISO 10375	
			ISO 10376	
			ISO 10377	
			ISO 10378	
			ISO 10379	
			ISO 10380	
			ISO 10381	
			ISO 10382	
			ISO 10383	
			ISO 10384	
			ISO 10385	
			ISO 10386	
			ISO 10387	
			ISO 10388	
			ISO 10389	
			ISO 10390	
			ISO 10391	
			ISO 10392	
			ISO 10393	
			ISO 10394	
			ISO 10395	
			ISO 10396	
			ISO 10397	
			ISO 10398	
			ISO 10399	
			ISO 10400	
			ISO 10401	
			ISO 10402	
			ISO 10403	
			ISO 10404	
			ISO 10405	
			ISO 10406	
			ISO 10407	
			ISO 10408	
			ISO 10409	
			ISO 10410	
			ISO 10411	
			ISO 10412	
			ISO 10413	
			ISO 10414	
			ISO 10415	
			ISO 10416	
			ISO 10417	
			ISO 10418	
			ISO 10419	
			ISO 10420	
			ISO 10421	
			ISO 10422	
			ISO 10423	
			ISO 10424	
			ISO 10425	
			ISO 10426	
			ISO 10427	
			ISO 10428	
			ISO 10429	
			ISO 10430	
			ISO 10431	
			ISO 10432	
			ISO 10433	
			ISO 10434	
			ISO 10435	
			ISO 10436	
			ISO 10437	
			ISO 10438	
			ISO 10439	
			ISO 10440	
			ISO 10441	
			ISO 10442	
			ISO 10443	
			ISO 10444	
			ISO 10445	
			ISO 10446	
			ISO 10447	
			ISO 10448	
			ISO 10449	
			ISO 10450	
			ISO 10451	
			ISO 10452	
			ISO 10453	
			ISO 10454	
			ISO 10455	
			ISO 10456	
			ISO 10457	
			ISO 10458	
			ISO 10459	
			ISO 10460	
			ISO 10461	
			ISO 10462	
			ISO 10463	
			ISO 10464	
			ISO 10465	
			ISO 10466	
			ISO 10467	
			ISO 10468	
			ISO 10469	
			ISO 10470	
			ISO 10471	
			ISO 10472	
			ISO 10473	
			ISO 10474	
			ISO 10475	
			ISO 10476	
			ISO 10477	
			ISO 10478	
			ISO 10479	
			ISO 10480	
			ISO 10481	
			ISO 10482	
			ISO 10483	
			ISO 10484	
			ISO 10485	
			ISO 10486	
			ISO 10487	
			ISO 10488	
			ISO 10489	
			ISO 10490	
			ISO 10491	
			ISO 10492	
			ISO 10493	
			ISO 10494	
			ISO 10495	
			ISO 10496	
			ISO 10497	
			ISO 10498	
			ISO 10499	
			ISO 10500	
			ISO 10501	
			ISO 10502	
			ISO 10503	
			ISO 10504	
			ISO 10505	
			ISO 10506	
			ISO 10507	
			ISO 10508	
			ISO 10509	
			ISO 10510	
			ISO 10511	
			ISO 10512	
			ISO 10513	
			ISO 10514	
			ISO 10515	
			ISO 10516	
			ISO 10517	
			ISO 10518	
			ISO 10519	
			ISO 10520	
			ISO 10521	
			ISO 10522	
			ISO 10523	
			ISO 10524	
			ISO 10525	
			ISO 10526	
			ISO 10527	
			ISO 10528	
			ISO 10529	
			ISO 10530	
			ISO 10531	
			ISO 10532	
			ISO 10533	
			ISO 10534	
			ISO 10535	
			ISO 10536	
			ISO 10537	
			ISO 10538	
			ISO 10539	
			ISO 10540	
			ISO 10541	
			ISO 10542	
			ISO 10543	
			ISO 10544	
			ISO 10545	
			ISO 10546	
			ISO 10547	
			ISO 10548	
			ISO 10549	
			ISO 10550	
			ISO 10551	
			ISO 10552	
			ISO 10553	
			ISO 10554	
			ISO 10555	
			ISO 10556	
			ISO 10557	
			ISO 10558	
			ISO 10559	
			ISO 10560	
			ISO 10561	
			ISO 10562	
			ISO 10563	
			ISO 10564	
			ISO 10565	
			ISO 10566	
			ISO 10567	
			ISO 10568	
			ISO 10569	
			ISO 10570	
			ISO 10571	
			ISO 10572	
			ISO 10573	
			ISO 10574	
			ISO 10575	
			ISO 10576	
			ISO 10577	
			ISO 10578	
			ISO 10579	
			ISO 10580	
			ISO 10581	
			ISO 10582	
			ISO 10583	
			ISO 10584	
			ISO 10585	
			ISO 10586	
			ISO 10587	
			ISO 10588	
			ISO 10589	
			ISO 10590	
			ISO 10591	
			ISO 10592	
			ISO 10593	
			ISO 10594	
			ISO 10595	
			ISO 10596	
			ISO 10597	
			ISO 10598	
			ISO 10599	
			ISO 10600	
			ISO 10601	
			ISO 10602	
			ISO 10603	
			ISO 10604	
			ISO 10605	
			ISO 10606	
			ISO 10607	
			ISO 10608	
			ISO 10609	
			ISO 10610	
			ISO 10611	
			ISO 10612	
			ISO 10613	
			ISO 10614	
			ISO 10615	
			ISO 10616	
			ISO 10617	
			ISO 10618	
			ISO 10619	
			ISO 10620	
			ISO 10621	
			ISO 10622	
			ISO 10623	
			ISO 10624	
			ISO 10625	
			ISO 10626	
			ISO 10627	
			ISO 10628	
			ISO 10629	
			ISO 10630	
			ISO 10631	
			ISO 10632	
			ISO 10633	
			ISO 10634	
			ISO 10635	
			ISO 10636	
			ISO 10637	
			ISO 10638	
			ISO 10639	
			ISO 10640	
			ISO 10641	
			ISO 10642	
			ISO 10643	
			ISO 10644	
			ISO 10645	
			ISO 10646	
			ISO 10647	
			ISO 10648	
			ISO 10649	
			ISO 10650	
			ISO 10651	
			ISO 10652	

Dimensions might be shown with or without decimals and indicated as mm [inches]. Tolerance on drawings is +/- 1mm. For accurate measurements, check relevant DWG file.

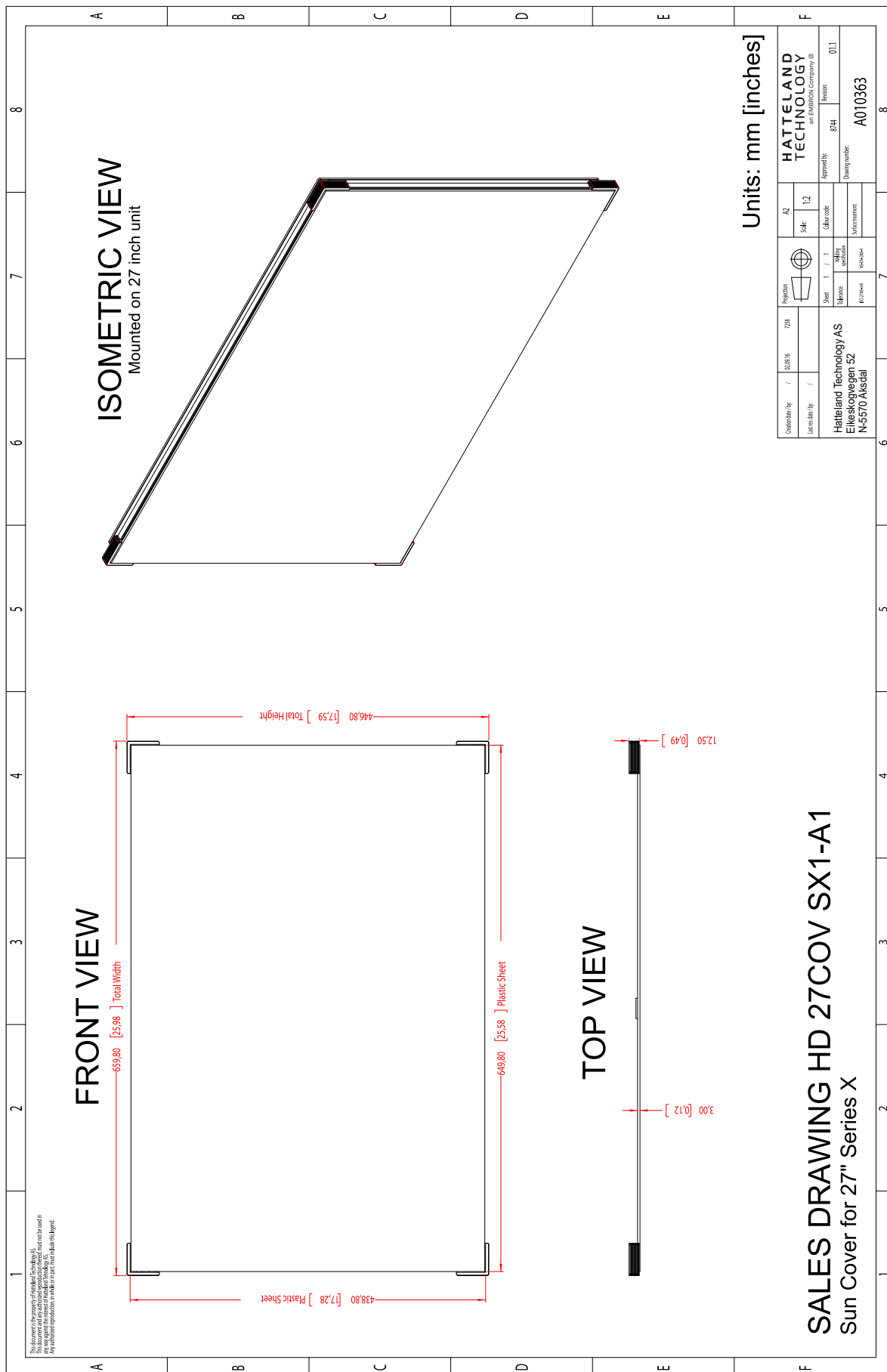

Technical Drawings - HD CAK SX2-A1

Dimensions might be shown with or without decimals and indicated as mm [inches]. Tolerance on drawings is +/- 1mm. For accurate measurements, check relevant DWG file.

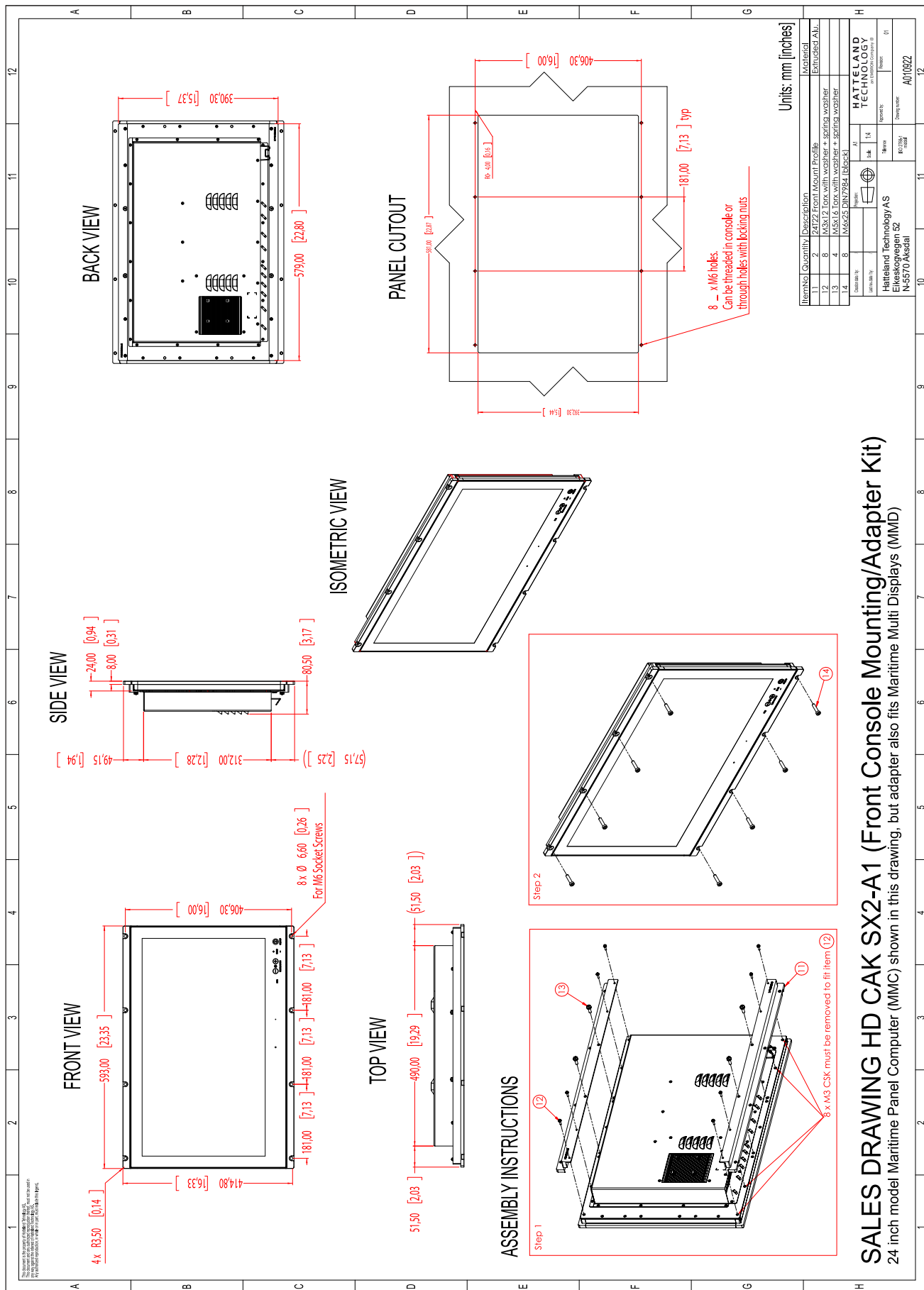

SALES DRAWING HD CAK SX2-A1 (Front Console Mounting/Adapter Kit)

24 inch model Maritime Panel Computer (MMC) shown in this drawing, but adapter also fits Maritime Multi Displays (MMD)

This document is the property of Hatteland Technology AS. This document and any authorized reproduction thereof, must not be used in any way against the interest of Hatteland Technology AS. Any authorized reproduction, in whole or in part, must include this legend. Hatteland Technology AS Proprietary information. Not to be distributed to any third party without written permission.

Technical Drawings - HD CAK SX2-B1

Dimensions might be shown with or without decimals and indicated as mm [inches]. Tolerance on drawings is +/- 1mm. For accurate measurements, check relevant DWG file.

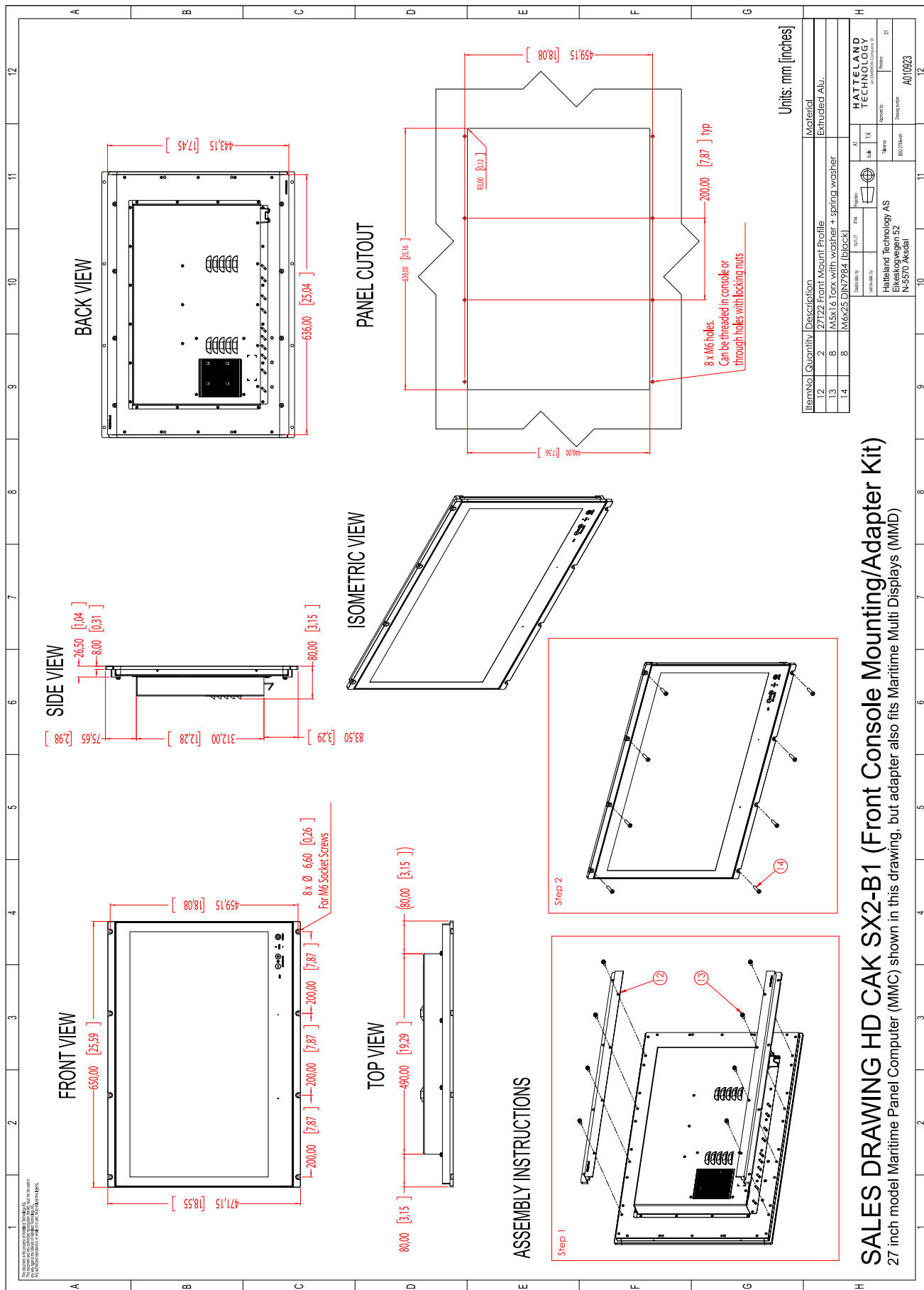

SALES DRAWING HD CAK SX2-B1 (Front Console Mounting/Adapter Kit) 27 inch model Maritime Panel Computer (MMC) shown in this drawing, but adapter also fits Maritime Multi Displays (MMD)

This document is the property of HatteLand Technology AS. This document and any authorized reproduction thereof, must not be used in any way against the interest of HatteLand Technology AS. Any authorized reproduction, in whole or in part, must include this legend. HatteLand Technology AS Proprietary information. Not to be distributed to any third party without written permission.

Technical Drawings - P006997-1

Dimensions might be shown with or without decimals and indicated as mm [inches]. Tolerance on drawings is +/- 1mm. For accurate measurements, check relevant DWG file.

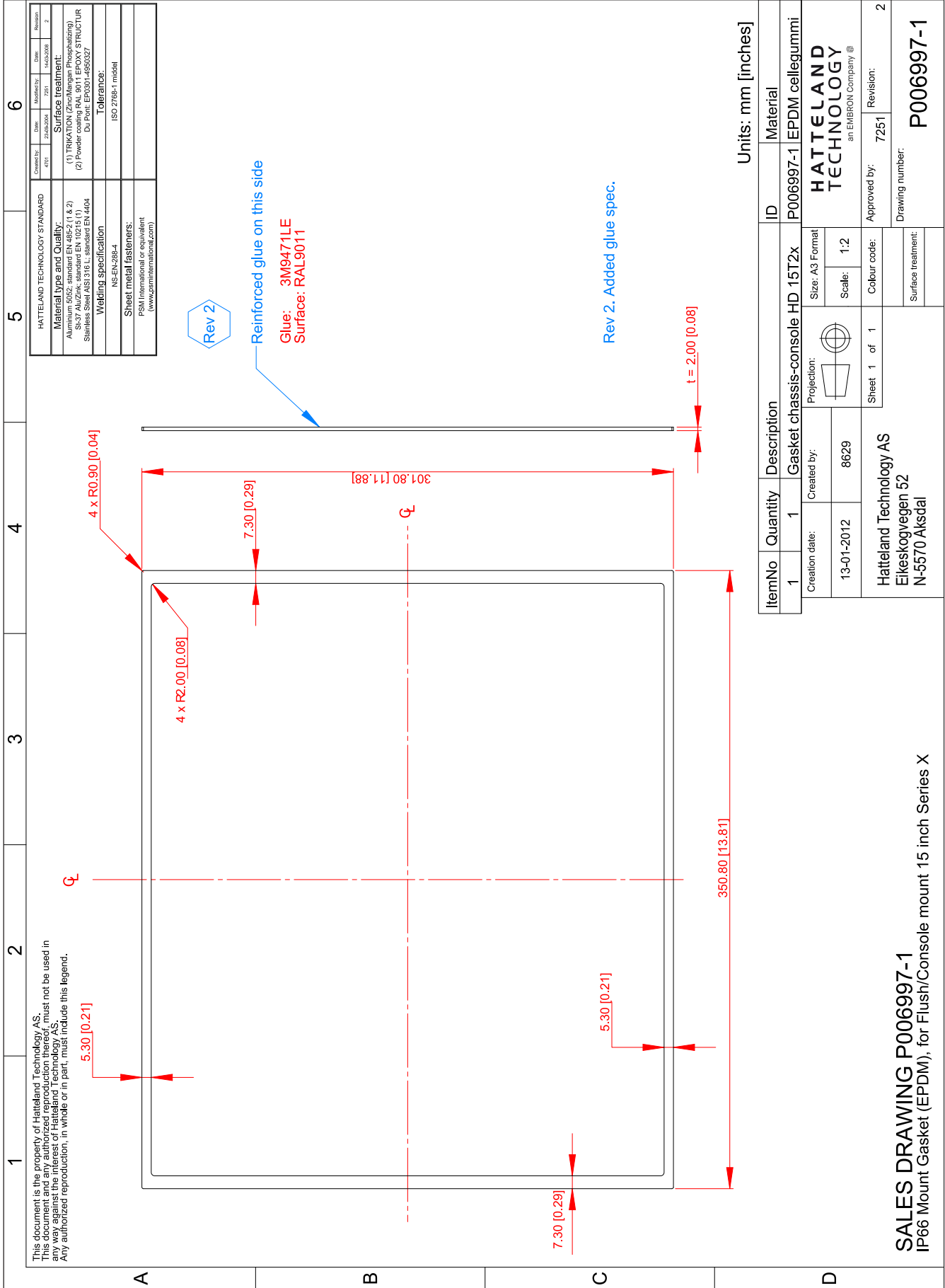

HATTELAND TECHNOLOGY STANDARD	
Company:	Year:
2001	2011
2011	14032001
2	2
Material type and Quality:	
(1) TRIKATION (Zink/Nickel/Phosphating)	
(2) Powder coating RAL 9011 EPOXY STRUCTUR	
Du. Pont: EP0301-4890327	
Tolerance:	
ISO 2768-1 mittel	
Sheet metal fasteners:	
PSM International or equivalent	
(www.psminternational.com)	
Welding specification	
NS-EN-988-4	

HATTELAND TECHNOLOGY STANDARD	
Company:	Year:
2001	2011
2011	14032001
2	2
Material type and Quality:	
(1) TRIKATION (Zink/Nickel/Phosphating)	
(2) Powder coating RAL 9011 EPOXY STRUCTUR	
Du. Pont: EP0301-4890327	
Tolerance:	
ISO 2768-1 mittel	
Sheet metal fasteners:	
PSM International or equivalent	
(www.psminternational.com)	
Welding specification	
NS-EN-988-4	

This document is the property of Hatteland Technology AS. This document and any authorized reproduction thereof, must not be used in any way against the interest of Hatteland Technology AS. Any authorized reproduction, in whole or in part, must include this legend.

IP66 Panel Gasket (15 inch)

147

This document is the property of Hatteland Technology AS. This document and any authorized reproduction thereof, must not be used in any way against the interest of Hatteland Technology AS. Any authorized reproduction, in whole or in part, must include this legend. Hatteland Technology AS Proprietary information. Not to be distributed to any third party without written permission.

SALES DRAWING P006997-1
IP66 Mount Gasket (EPDM), for Flush/Console mount 15 inch Series X

Creation date:	13-01-2012	Created by:	8629
Projection:		Size: A3 Format:	
Scale:	1:2	Colour code:	
Sheet 1 of 1		Approved by:	7251
Hatteland Technology AS Eikeskogvegen 52 N-5570 Akksdal		Revision:	2
Surface treatment:		Drawing number:	P006997-1

Technical Drawings - P007130-1

Dimensions might be shown with or without decimals and indicated as mm [inches]. Tolerance on drawings is +/- 1mm. For accurate measurements, check relevant DWG file.

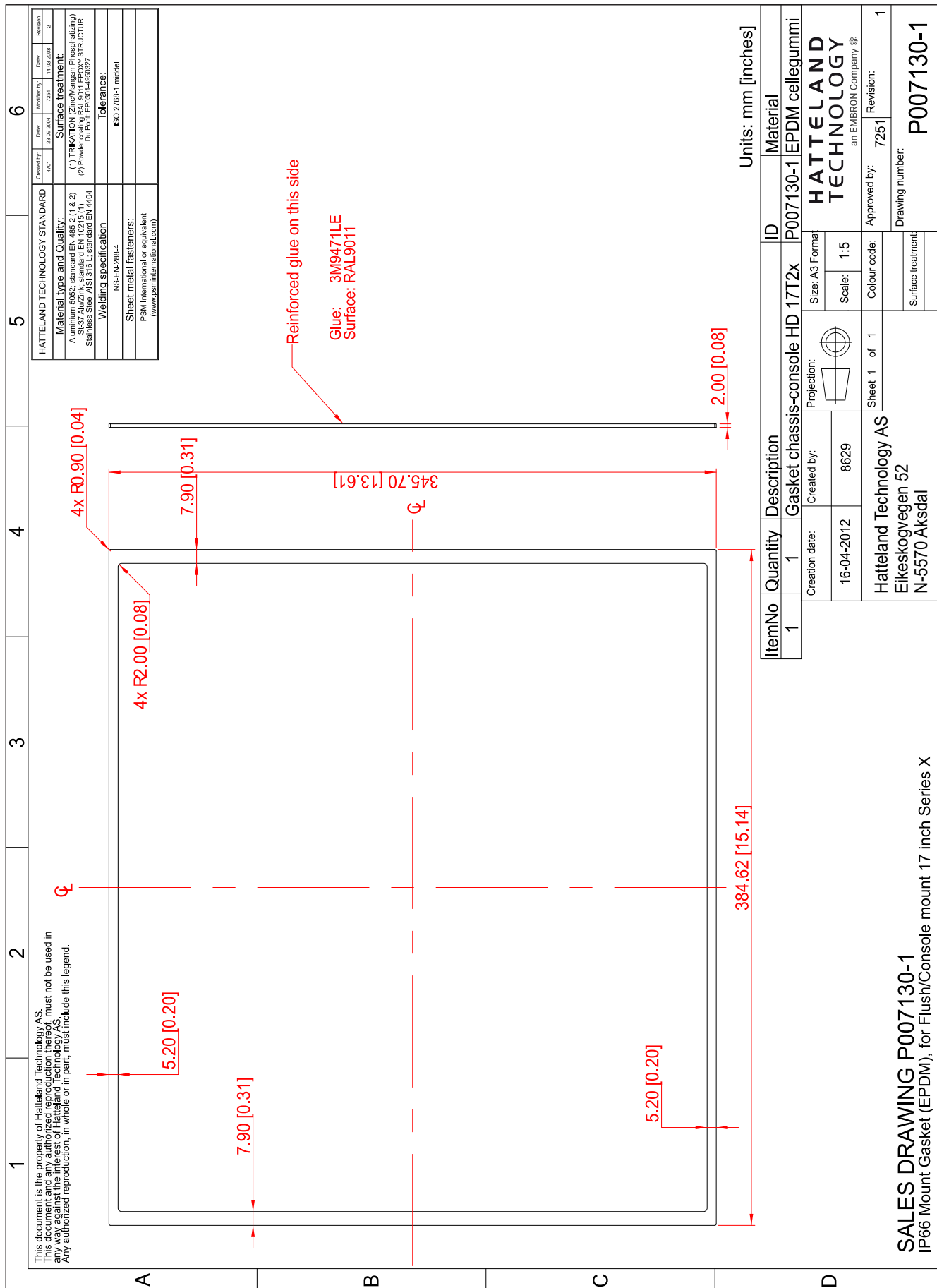

This document is the property of Hatteland Technology AS. This document and any authorized reproduction thereof, must not be used in any way against the interest of Hatteland Technology AS. Any authorized reproduction, in whole or in part, must include this legend. Hatteland Technology AS Proprietary information. Not to be distributed to any third party without written permission.

Technical Drawings - P007131-1

Dimensions might be shown with or without decimals and indicated as mm [inches]. Tolerance on drawings is +/- 1mm. For accurate measurements, check relevant DWG file.

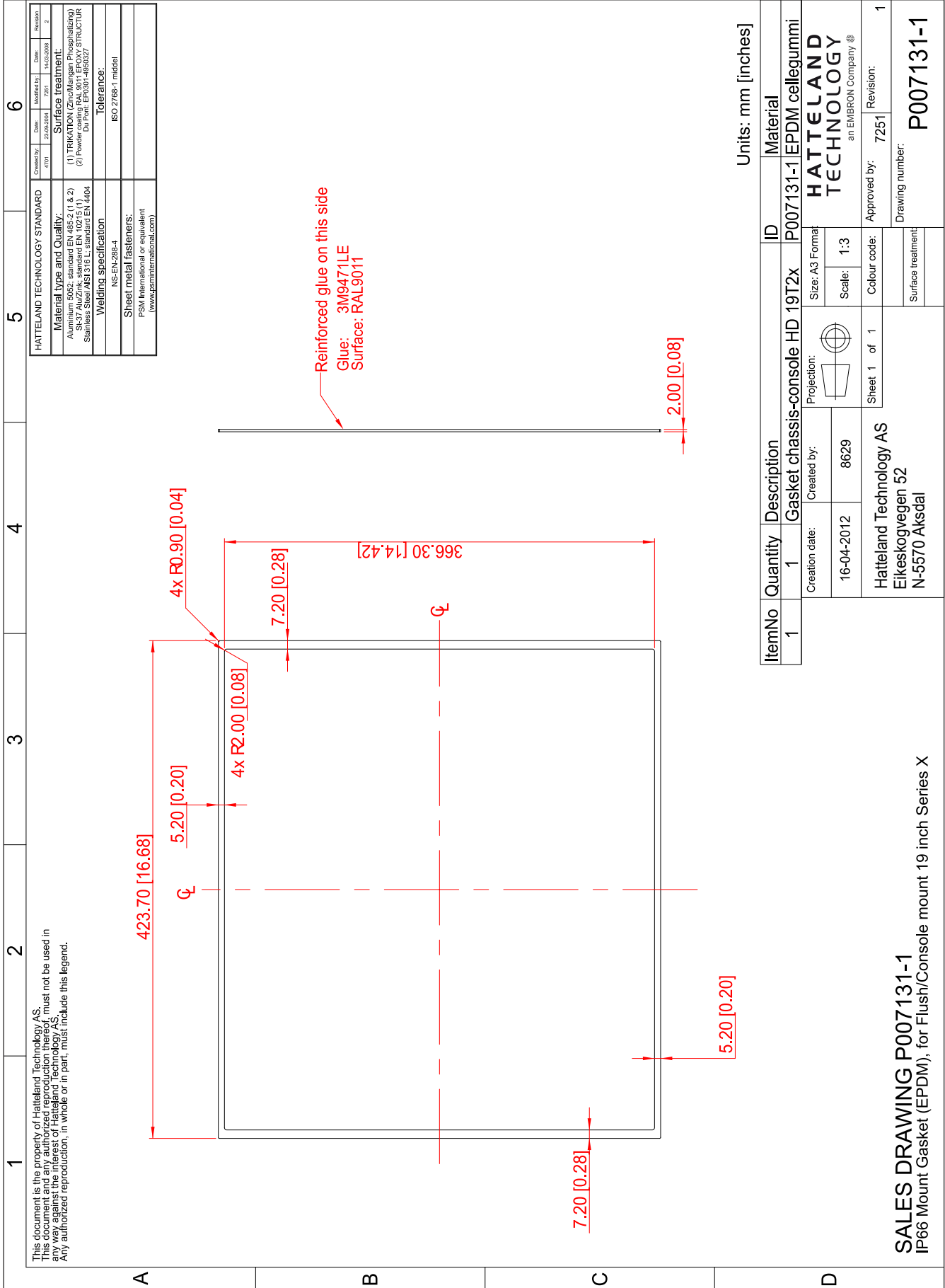

Units: mm [inches]

This document is the property of Hatteland Technology AS. This document and any authorized reproduction thereof, must not be used in any way against the interest of Hatteland Technology AS. Any authorized reproduction, in whole or in part, must include this legend.

This document is the property of Hatteland Technology AS. This document and any authorized reproduction thereof, must not be used in any way against the interest of Hatteland Technology AS. Any authorized reproduction, in whole or in part, must include this legend. Hatteland Technology AS Proprietary information. Not to be distributed to any third party without written permission.

Technical Drawings - P022211

Dimensions might be shown with or without decimals and indicated as mm [inches]. Tolerance on drawings is +/- 1mm. For accurate measurements, check relevant DWG file.

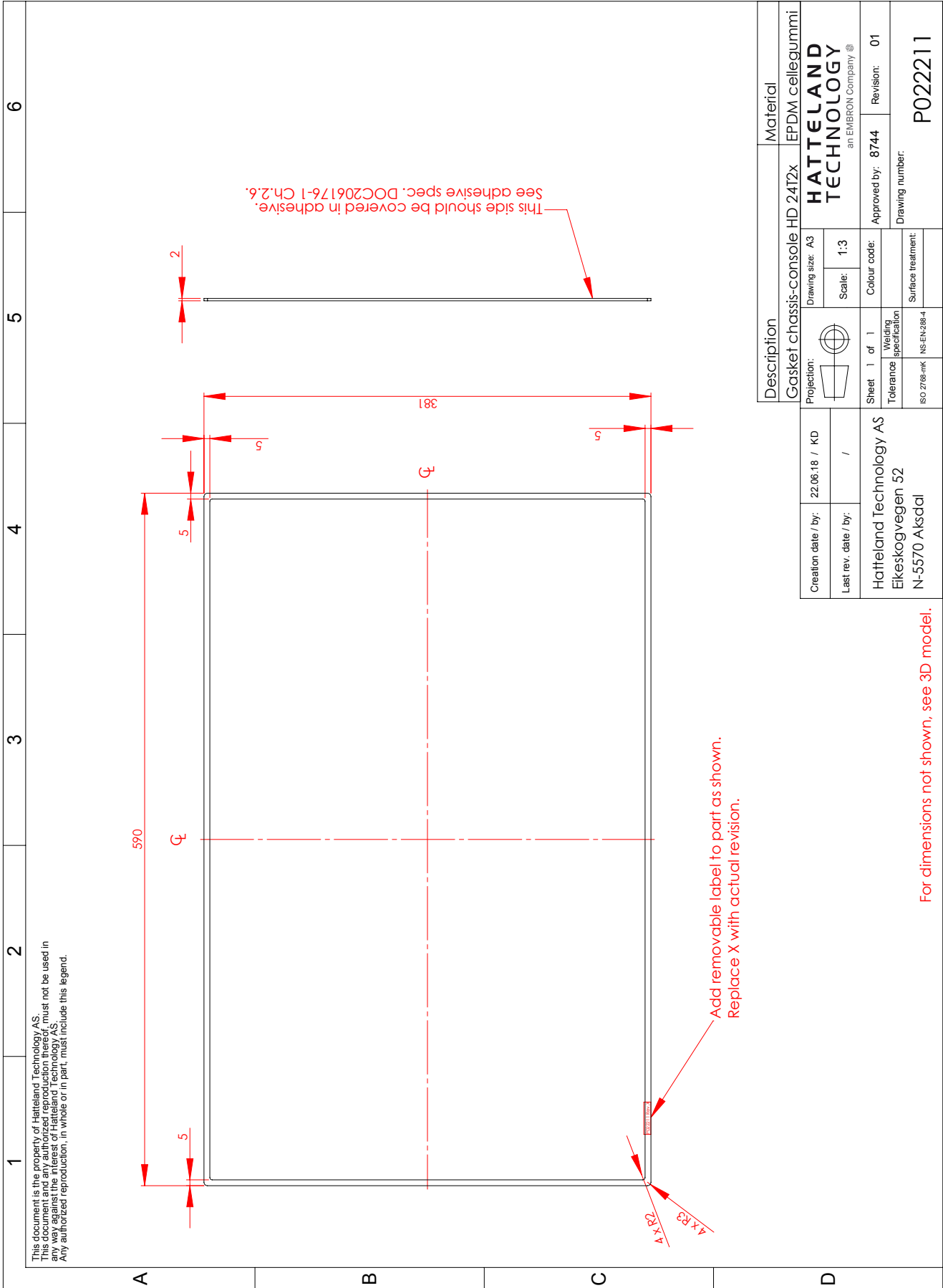

This document is the property of Hatteland Technology AS. This document and any authorized reproduction thereof, must not be used in any way against the interest of Hatteland Technology AS. Any authorized reproduction, in whole or in part, must include this legend. Hatteland Technology AS Proprietary information. Not to be distributed to any third party without written permission.

IP66 Panel Gasket (24 inch)

150

Technical Drawings - P007178

Dimensions might be shown with or without decimals and indicated as mm [inches]. Tolerance on drawings is +/- 1mm. For accurate measurements, check relevant DWG file.

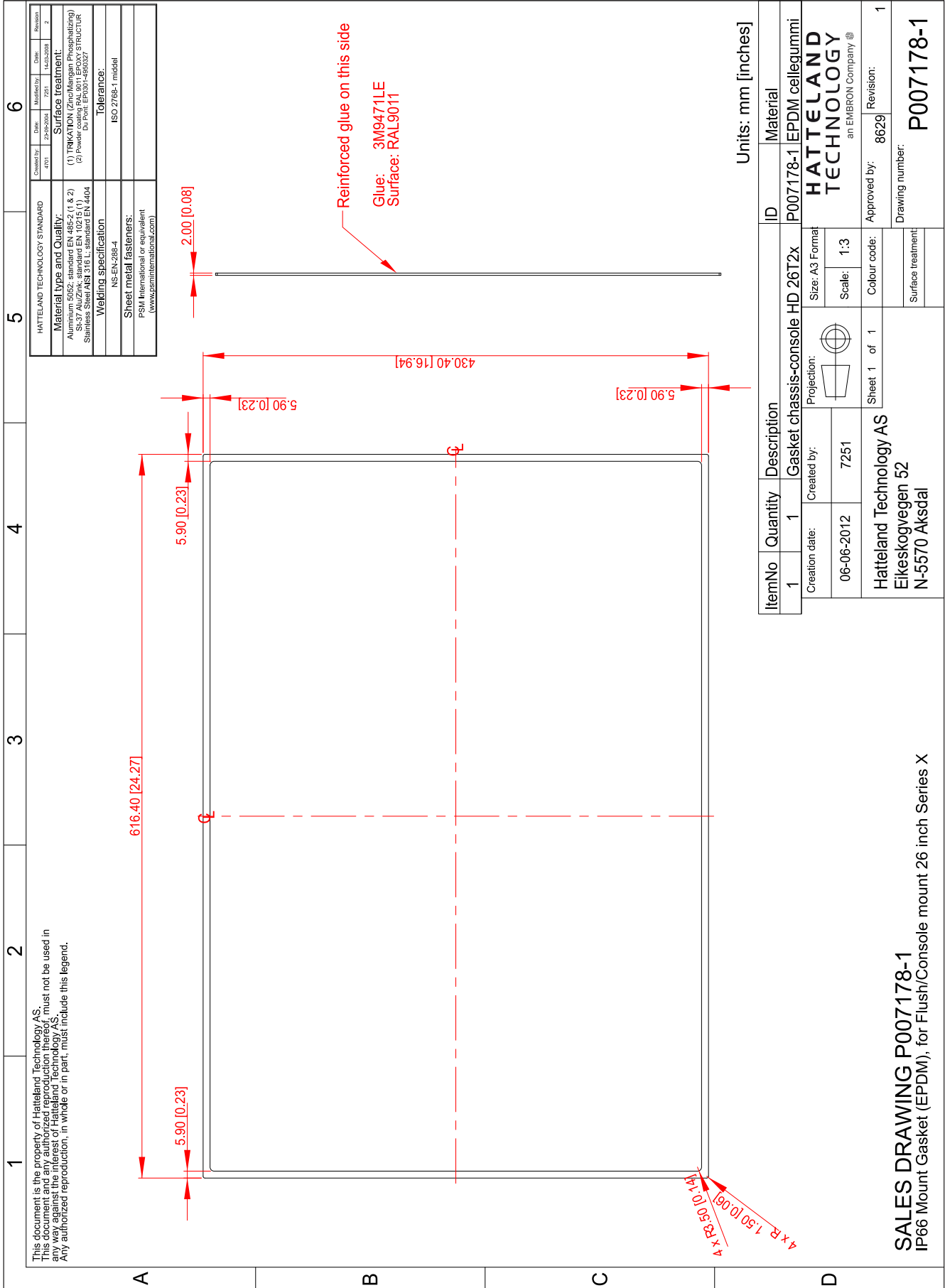

This document is the property of Hatteland Technology AS. This document and any authorized reproduction thereof, must not be used in any way against the interest of Hatteland Technology AS. Any authorized reproduction, in whole or in part, must include this legend. Hatteland Technology AS Proprietary information. Not to be distributed to any third party without written permission.

Technical Drawings - P018743

Dimensions might be shown with or without decimals and indicated as mm [inches]. Tolerance on drawings is +/- 1mm. For accurate measurements, check relevant DWG file.

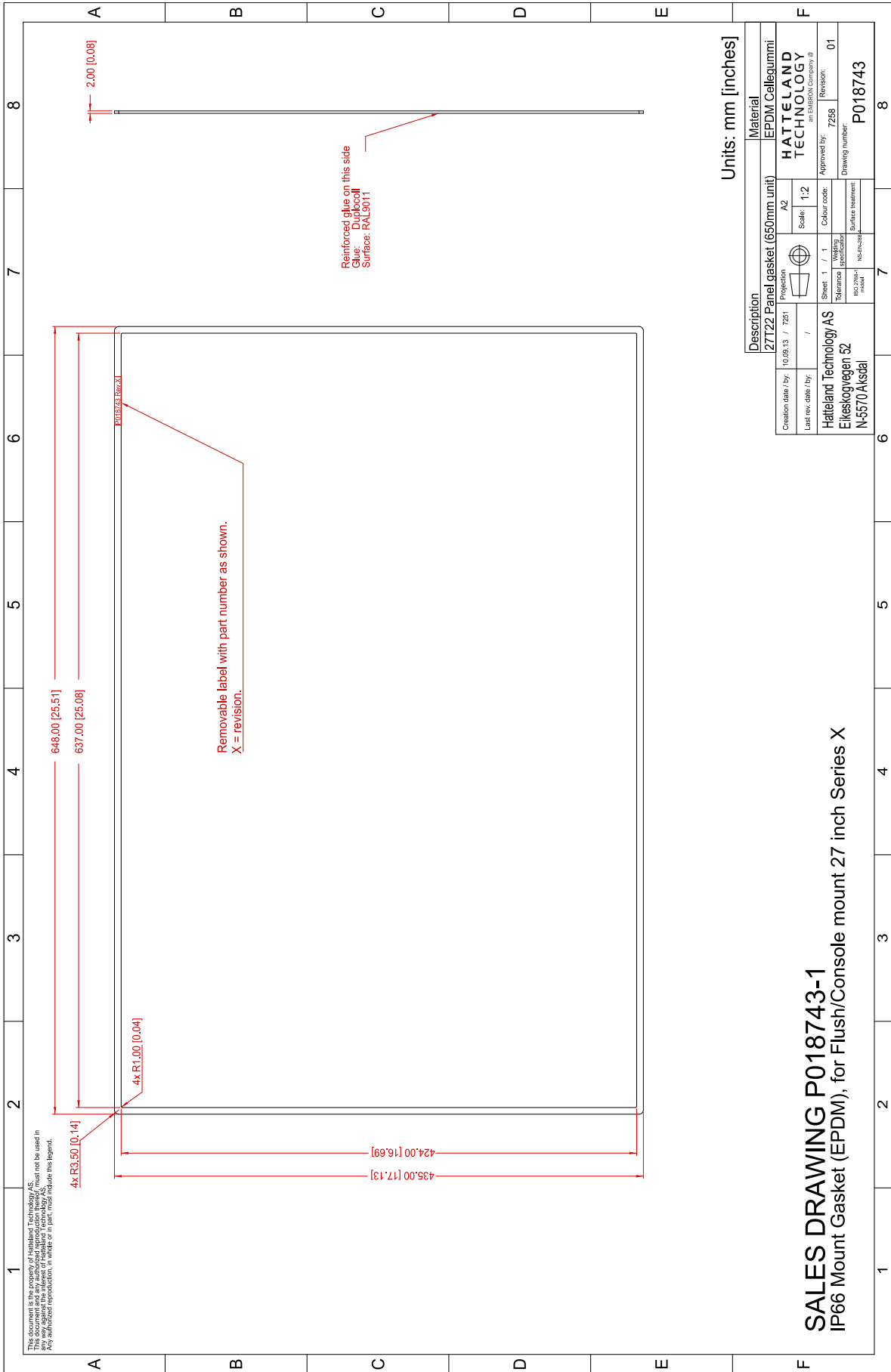

IP66 Panel Gasket (27 inch)

152

This document is the property of Hatteland Technology AS. This document and any authorized reproduction thereof, must not be used in any way against the interest of Hatteland Technology AS. Any authorized reproduction, in whole or in part, must include this legend. Hatteland Technology AS Proprietary information. Not to be distributed to any third party without written permission.

Technical Drawings - HD REM SX1-A1

Dimensions might be shown with or without decimals and indicated as mm [inches]. Tolerance on drawings is +/- 1mm. For accurate measurements, check relevant DWG file.

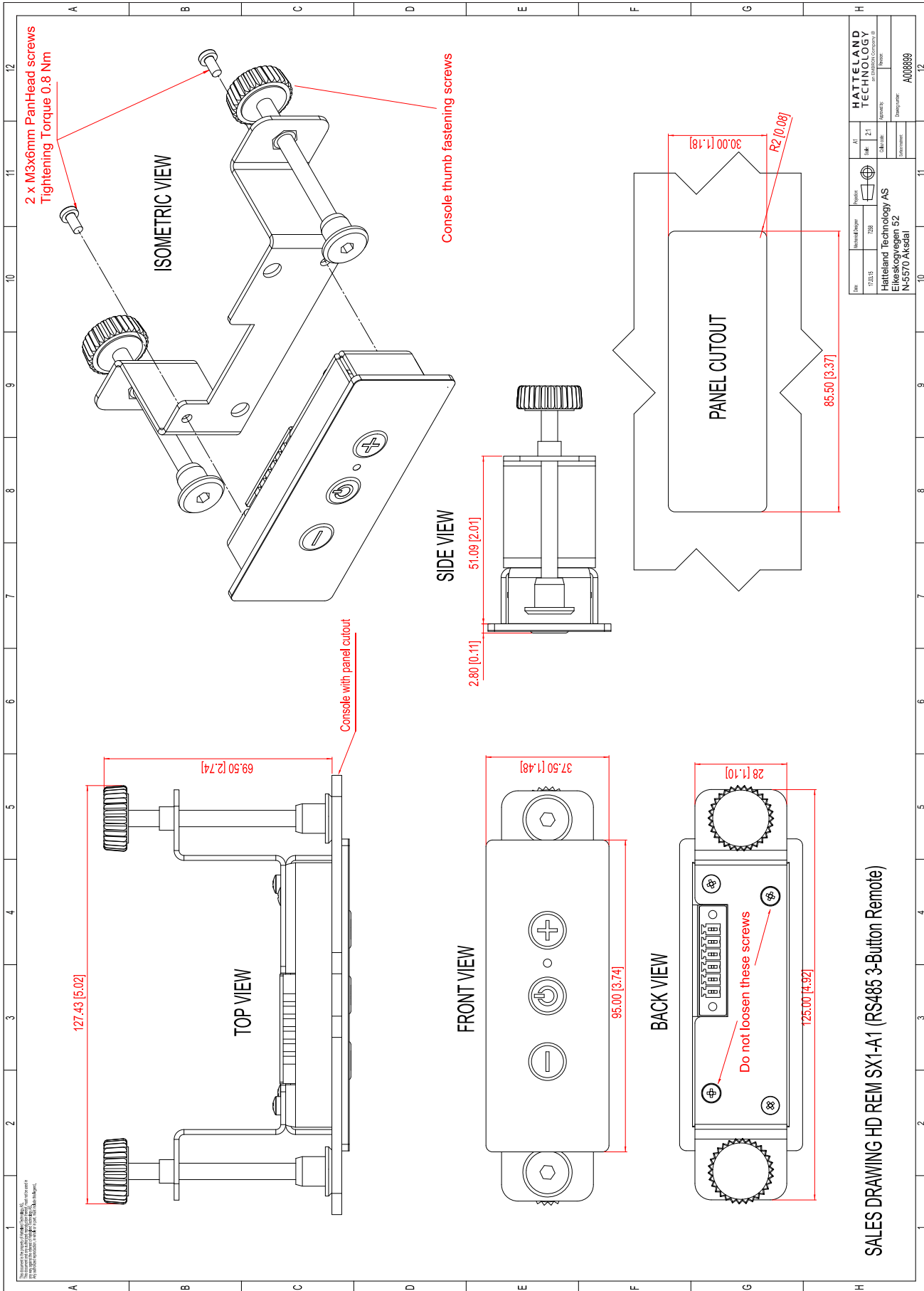

SALES DRAWING HD REM SX1-A1 (RS485 3-Button Remote)

This document is the property of Hatteland Technology AS. This document and any authorized reproduction thereof, must not be used in any way against the interest of Hatteland Technology AS. Any authorized reproduction, in whole or in part, must include this legend. Hatteland Technology AS Proprietary information. Not to be distributed to any third party without written permission.

This page left intentionally blank



Appendixes

UHF Interference Prevention

Note: Information below is an excerpt from original document located on Engineering Change Notification: https://www.hattelandtechnology.com/product-notifications/series-x-g2-maritime-multi-display-mmd-firmware-update-24_2020_ecn

5.3 Glass Display Controller Calibration

To calibrate the GDC (Glass display controller) to be better able to distinguish between UHF interference and a finger press on the "buttons", the GDC must be calibrated.

How to calibrate the acceptable threshold for the GDC:

1. Open the folder 2.uC Firmware FW100002 and then the folder "Tools".

<input type="checkbox"/> Name	Type	Compressed size	Password ...	Size
Firmware	File folder			
hd_swidl_3	File folder			
<input checked="" type="checkbox"/> Tools	File folder			
FW_Update	Windows Batch File	1 KB	No	1 KB
Power_ON	Windows Batch File	1 KB	No	1 KB

2. Click "start_calibration.bat"
3. Enter the COM Port ID that is connected to the display (example: 3) then press "Enter"



4. The script will start to run (do not press any key on the computer keyboard yet, the user calibration has now started):

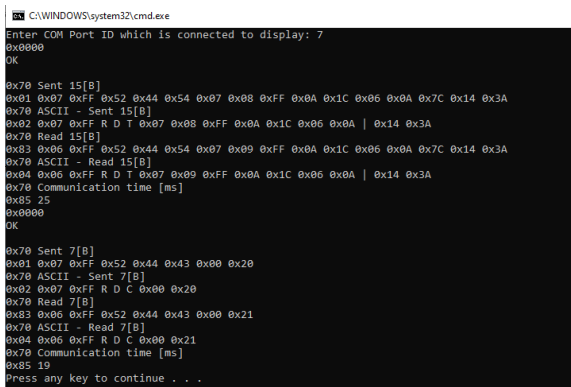

5. The "buttons" on the GDC will now light up one by one.
6. Press the "button" indicated (the button that is lit up), with a "normal" finger press.

- 1st **Power** "button"
- 2nd + "button"
- 3rd - "button"
- 4th > "button"
- 5th = "button"
- 6th < "button"

All buttons will light up once calibrated.

7. Once done, go back to the command window and press enter. the GDC is now calibrated.

5.4 Turning on/off UHF **protection** mode (OSD Key Outdoor mode)

To turn on/off the function for limiting the UHF interference on the Series X G2 Maritime Multi Displays, there are two ways of doing it.

1. Using SCOM commands.
2. Using the on-screen display menu.

<input type="checkbox"/> Name	Type	Compressed size	Password ...	Size
Firmware	File folder			
hd_swdl_3	File folder			
<input checked="" type="checkbox"/> Tools	File folder			
FW_Update	Windows Batch File	1 KB	No	1 KB
Power_ON	Windows Batch File	1 KB	No	1 KB

5.4.1 How to turn On/Off UHF protection using SCOM:

1. Open the folder "tools"
2. Run the .bat file "Radio_Protection_ODM_ON.bat" to turn the protection on
Or
Run the .bat file "Radio_Protection_ODM_OFF.bat" to turn the protection off
3. Enter the COM Port ID connected to the display (example: 3) then press enter

```
C:\WINDOWS\system32\cmd.exe
Enter COM Port ID which is connected to display: 7
0x0000
OK
0x70 Sent 9[B]
0x01 0x07 0xFF 0x4F 0x44 0x4D 0x01 0x18 0xFF 0x00
0x70 ASCII - Sent 9[B]
0x02 0x07 0xFF 0 D M 0x01 0x18 0xFF 0x00
0x70 Read 9[B]
0x83 0x06 0xFF 0x4F 0x44 0x4D 0x01 0x19 0xFF 0x00
0x70 ASCII - Read 9[B]
0x04 0x06 0xFF 0 D M 0x01 0x19 0xFF 0x00
0x70 Communication time [ms]
0x85 23
Press any key to continue . . .
```

4. Press enter and the UHF protection is turned on or off.

5.4.2 How to turn On/Off UHF protection using On-screen Display:

1. Go to **OSD Menu** > "**OSD Miscellaneous**" > **OSD Mode** set it to "**Service**" and use this password: **911**.
2. Go to **OSD Menu** > "**OSD Miscellaneous**" > **OSD Key Outdoor** Set it to "On" or "Off" dependent on wanted function to be on or off.

Pinout Assignments

Connectors illustrated here are either standard by factory default or may be available (through factory customization). Note that some combinations may not be possible due to space restrictions. List also valid for customized models. All pin out assignments are seen from users Point of View (POV) while looking straight at the connector. Please review the dedicated datasheet or technical drawings for your actual unit to identify and determine the presence of desired connector. Detailed information about Housing Connectors (terminal blocks) can be found earlier in this manual.

18/24/24+5 pin DVI-D, DVI-I, Single Link, Dual Link Combined Female

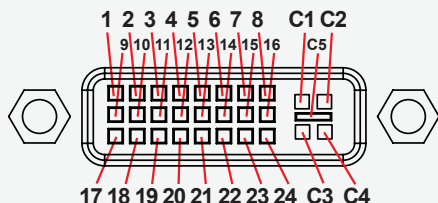

PIN 01	T.M.D.S. Data2 - (Digital - RED link 1)
PIN 02	T.M.D.S. Data2 + (Digital + RED link 1)
PIN 03	T.M.D.S. Data2/4 Shield
PIN 04	T.M.D.S. Data4 - (Digital - GREEN link 2)
PIN 05	T.M.D.S. Data4 + (Digital + GREEN link 2)
PIN 06	DDC Clock
PIN 07	DDC Data
PIN 08	Analog Vertical Sync (DVI-I only)
PIN 09	T.M.D.S. Data1 - (Digital - GREEN link 1)
PIN 10	T.M.D.S. Data1 + (Digital + GREEN link 1)
PIN 11	T.M.D.S. Data1/3 Shield
PIN 12	T.M.D.S. Data3 - (Digital - BLUE link 2)
PIN 13	T.M.D.S. Data3 + (Digital + BLUE link 2)
PIN 14	+5V Power (for standby mode)
PIN 15	Ground (for +5V and analog sync)
PIN 16	Hot Plug Detect
PIN 17	T.M.D.S. Data0 - (Digital - BLUE link 1) and digital sync.
PIN 18	T.M.D.S. Data0 + (Digital + BLUE link 1) and digital sync.
PIN 19	T.M.D.S. Data0/5 Shield
PIN 20	T.M.D.S. Data5 - (Digital - RED link 2)
PIN 21	T.M.D.S. Data5 + (Digital - RED link 2)
PIN 22	T.M.D.S. Clock Shield
PIN 23	T.M.D.S. Clock + (Digital clock + (Links 1 and 2)
PIN 24	T.M.D.S. Clock - (Digital clock - (Links 1 and 2)
PIN C1	Analog RED
PIN C2	Analog GREEN
PIN C3	Analog BLUE
PIN C4	Analog Horizontal Sync.
PIN C5	Analog Ground (return for RGB signals)

DDC = Display Data Channel.

T.M.D.S = Transition Minimized Differential Signal

PIN C1,C2,C3,C4 = Only present on DVI-I connectors.

NOTE: Connector shows a DUAL LINK design, but some units may not support it. Only units with 1920x1200 or more in resolution require / support DUAL LINK.

8-pin RJ45 10/100/1000Mbps LAN/Ethernet

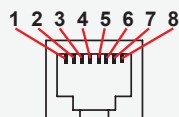

PIN 01	D0P+	Differential Pair 0 (Positive)
PIN 02	D0N-	Differential Pair 0 (Negative)
PIN 03	D1P+	Differential Pair 1 (Positive)
PIN 04	D2P+	Differential Pair 2 (Positive)
PIN 05	D2N-	Differential Pair 2 (Negative)
PIN 06	D1N-	Differential Pair 1 (Negative)
PIN 07	D3P+	Differential Pair 3 (Positive)
PIN 08	D3N-	Differential Pair 3 (Negative)

Analog RGB/VGA, 15-pin DSUB High Density Female

Onboard or via DVI-4 adapter

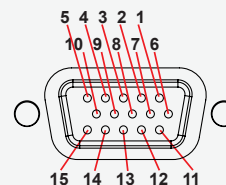

PIN 01	RED	Red, analog
PIN 02	GREEN	Green, analog
PIN 03	BLUE	Blue, analog
PIN 04	ID2/RES	Reserved for monitor ID bit 2 (grounded)
PIN 05	GND	Digital ground
PIN 06	RED RTN	Analog ground red
PIN 07	GREEN RTN	Analog ground green
PIN 08	BLUE RTN	Analog ground blue
PIN 09	KEY/PWR	+5V power supply for DDC (optional)
PIN 10	GND	Digital ground
PIN 11	ID0/RES	Reserved for monitor ID bit 0 (grounded)
PIN 12	ID1/SDA	DDC serial data
PIN 13	HSYNC.	Horizontal sync or composite sync, input
PIN 14	VSYNC.	Vertical sync, input
PIN 15	ID3/SCL	DDC serial clock

20-pin DisplayPort (DP) Female

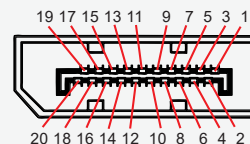

PIN 01	ML Lane 0 (p) - Lane 0 (positive)
PIN 02	GND - Ground
PIN 03	ML Lane 0 (n) - Lane 0 (negative)
PIN 04	ML Lane 1 (p) - Lane 1 (positive)
PIN 05	GND - Ground
PIN 06	ML Lane 1 (n) - Lane 1 (negative)
PIN 07	ML Lane 2 (p) - Lane 2 (positive)
PIN 08	GND - Ground
PIN 09	ML Lane 2 (n) - Lane 2 (negative)
PIN 10	ML Lane 3 (p) - Lane 3 (positive)
PIN 11	GND - Ground
PIN 12	ML Lane 3 (n) - Lane 3 (negative)
PIN 13*	CONFIG1 - connected to Ground*
PIN 14*	CONFIG2 - connected to Ground*
PIN 15	AUX CH (p) - Auxiliary Channel (positive)
PIN 16	GND - Ground
PIN 17	AUX CH (n) - Auxiliary Channel (negative)
PIN 18	Hot Plug - Hot Plug Detect
PIN 19	Return - Return for Power
PIN 20	DP_PWR - Power for connector (3.3 V 500 mA)

*Pins 13 and 14 may either be directly connected to ground or connected to ground through a pull-down device. This is the pinout for source-side connector, the sink-side connector pinout will have lanes 0-3 reversed in order; i.e., lane 3 will be on pin 1(n) and 3(p) while lane 0 will be on pin 10(n) and 12(p).

Pinout Assignments

Potentiometer Control, 9-pin DSUB Male

Warning: Do not connect or disconnect cables/connectors to this connector while the Display unit is powered on. Failure to do so may result in damaged electronics inside the Display Unit

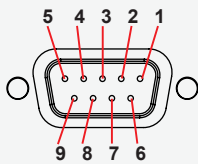

PIN 01	+5V	+5V out
PIN 02	PWR	Power On / Off
PIN 03	Res.	Reserved, do not connect
PIN 04	Aref	For potentiometer
PIN 05	+12V	+12V out
PIN 06	BRT_POT	Potentiometer in
PIN 07	BRT -	Button in
PIN 08	BRT+	Button in
PIN 09	GND	Ground

Potentiometer shall be **10kΩ LINEAR**. Connect like the illustrations shown below:

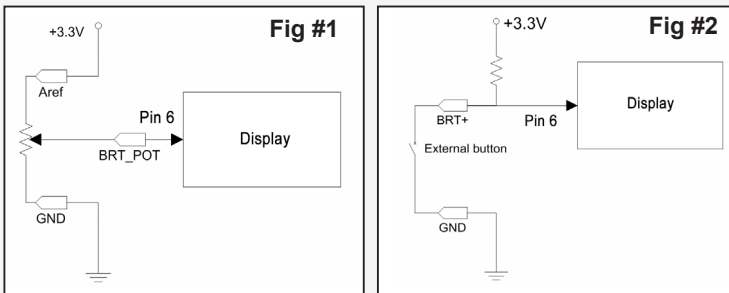

The BRT+ and BRT- can be used for controlling the brilliance by using external buttons. Example for the BRT+ input in figure #2:

Building your own cable:

Note: Requires soldering and assembly. It is expected that the technician has experience in electronics, soldering and assembling cables and connectors.

Pin 1 on product

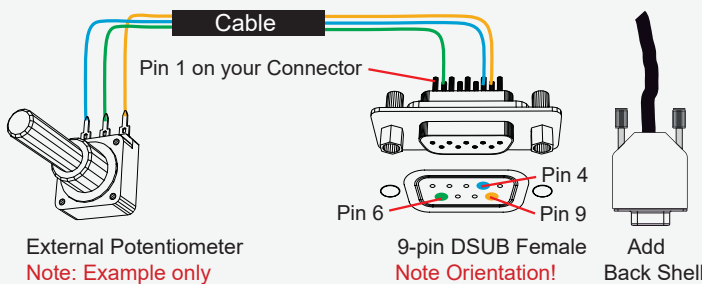
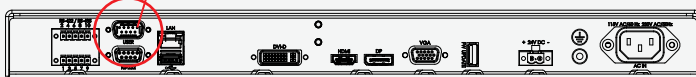

Use a cable that contains at least 3 wires (not 3 single wires). Heat Shrink Tubes must be applied to soldered wire/pins. Test connection (beep) with Voltage Meter. Test connection between power pin and other pins to ensure no short circuit is present prior to connecting cable and power on Display unit. Finally, the 9-pin DSUB must be covered by a back shell.

In order to activate the external Potentiometer control, the internal "POT" - Backlight Control Interface selection" command has to be set first via our SCOM (Serial Communication Control Interface).

Usage for SCOM: Review the dedicated Technical Manual available from our website: <https://www.hattelandtechnology.com/hubfs/pdfget/inb100018-6.htm>

External Power ON/OFF Control, 9-pin DSUB Male

Warning: Do not connect or disconnect cables/connectors to this connector while the Display unit is powered on. Failure to do so may result in damaged electronics inside the Display Unit

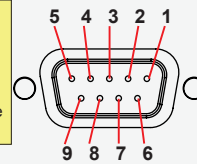

PIN 01	+5V	+5V out
PIN 02	PWR	Power On / Off
PIN 03	Res.	Reserved, do not connect
PIN 04	Aref	For potentiometer
PIN 05	+12V	+12V out
PIN 06	BRT_POT	Potentiometer in
PIN 07	BRT -	Button in
PIN 08	BRT+	Button in
PIN 09	GND	Ground

External Power Button must be of "Push Button" type. Instant-On. To turn off unit, Press & Hold down for 3 seconds.

Building your own Push Button for External Power Button:

Note: Requires soldering and assembly. It is expected that the technician has experience in electronics, soldering and assembling cables and connectors.

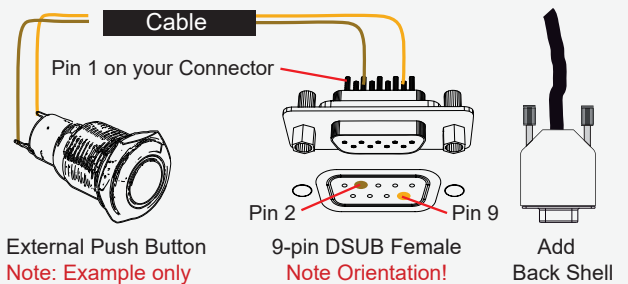

Use a cable that contains at least 2 wires (not 2 single wires). Heat Shrink Tubes must be applied to soldered wire/pins. Test connection (beep) with Voltage Meter.

In order to activate the external Power ON/OFF control it must be enabled:
Via OSD Menu: "OSD Miscellaneous>External Power Button" and set to Enable.
or
Via SCOM (Serial Communication Control Interface):
"MCC" - OSD Control Functionality -> "External Power Button (0x74)".

Usage for SCOM: Review the dedicated Technical Manual available from our website: <https://www.hattelandtechnology.com/hubfs/pdfget/inb100018-6.htm>

1-pin RCA/BNC COMP. VIDEO Female



2-pin Terminal Block 5.08 - DC Power Input

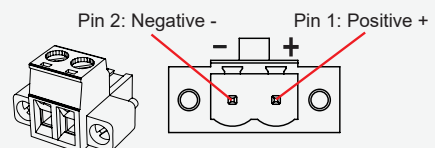

Pinout Assignments

10-pin RS-422 / RS-485 Module

"RS-422/RS-485 SCOM + Buzzer"

(Internal Buzzer can be controlled externally)

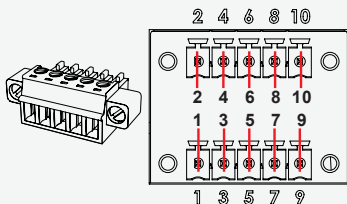

PIN 01*	RxD+	Receive Data Positive
PIN 02	GND	Ground
PIN 03*	RxD-	Receive Data Negative
PIN 04	+5V	+5V Out
PIN 05*	TxD+	Transmit Data Positive
PIN 06**	BUZ-	Buzzer Control Negative
PIN 07*	TxD-	Transmit Data Negative
PIN 08**	BUZ+	Buzzer Control Positive
PIN 09	GNDR	Ground 100Ω
PIN 10	GND	Ground

*Pin 1,3,5,7 = RS-485 Full Duplex (4-wire)

*Pin 5,7 = RS-485 Half Duplex (2-wire)

**See notes in blue.

Suggested "Buzzer" Control Logic inside Computer/System:

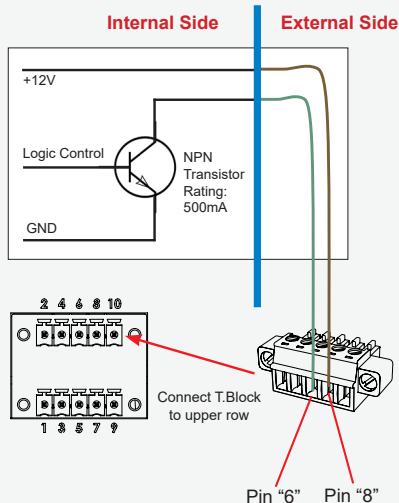

Note:

To ensure that EMC requirements are met, we recommend that the cable is screened and screen is terminated/grounded at both ends with as short as possible pig tail.

For Military/Naval use: +12V line from customer system should be low pass filter or else the power ripple may cause radiated emission to fail.

Use a cable that contains at least 2 wires (not 2 single wires). Test connection (beep) with Voltage Meter. Wires may be combined if using RS-422/485 COM as well.

Series X (G2 - Generation 2) / MVD Series:

- Display Unit needs external power connected to turn buzzer on. (Any logic power state).

Serial COM RS-232 non-isolated. 9-pin DSUB Female

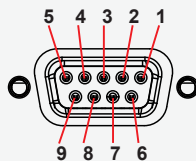

PIN 01**	BUZ+	Buzzer Control Positive IN*
PIN 02	TxD	Transmit Data
PIN 03	RxD	Receive Data
PIN 04	DTR	Data Terminal Ready
PIN 05	GND	Ground
PIN 06	DSR	Data Set Ready
PIN 07	RTS	Request To Send
PIN 08	CTS	Clear To Send
PIN 09**	BUZ-	Buzzer Control Negative IN*

RS232-Wake On Ring is not enabled. **See notes in blue.

Suggested "Buzzer" Control Logic inside Computer/System:

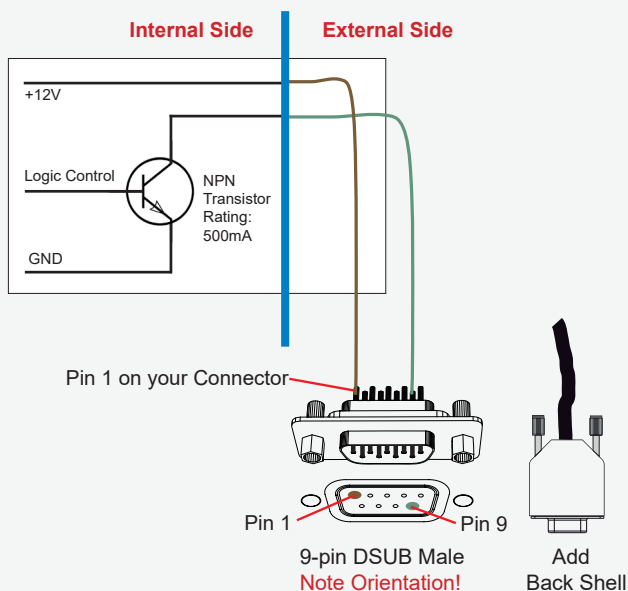

Note: Requires soldering and assembly. It is expected that the technician has experience in electronics, soldering and assembling cables and connectors. Use a cable that contains at least 2 wires (not 2 single wires). Heat Shrink Tubes must be applied to soldered wire/pins. Test connection (beep) with Voltage Meter. Wires may be combined if using RS-232 COM as well.

4-pin USB TYPE A

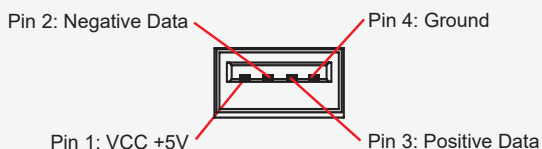

Basic Trouble-shooting

GENERAL ISSUES FOR TFT PANEL BASED PRODUCTS

Note: Applies for a range of various products. This is only meant as a general guide.

NO PICTURE / LED BEHAVIOUR:

If there is no light at all in the LED at the FRONT, check power cables. If the LED in front is green, then check if the brightness is set/adjusted to max brightness. Lack of image is most likely to be caused by incorrect connection, lack of power or wrong BIOS settings.

SCROLLING / UNSTABLE IMAGE:

Signal cable may not be completely connected to computer or TFT display. Check the pin assignments and signal timings of the display and your video card with respect to recommended timing and pin assignments. Make sure that the video card is compatible and that it is properly seated / installed on the computer.

DISPLAY AREA IS NOT CENTERED / SIZED CORRECTLY

Make sure that a supported video mode has been selected on the display, or on the video card / system. If it is impossible to position the image correctly, i.e. the image adjustment controls will not move the image far enough, then test it again using another graphics card for the PC system. This situation may occur with a custom graphics card that is not close to standard timings or if something is in the graphics line that may be affecting the signal, such as a signal splitter (please note that normally a signal splitter will not have any adverse effect). If it is impossible to change to the correct resolution/color depth, check if you have the right graphics driver installed in your system.

IMAGE APPEARANCE:

A faulty TFT panel can have black lines, pixel errors, failed sections, flickering or flashing image. Incorrect graphic card refresh rate, resolution or interlaced mode will probably cause the image to be the wrong size, it may scroll, flicker badly or possibly even no image is present. Sparkling on the display may be a faulty TFT panel signal cable, and it needs service attention.

VGA Signal Only: Horizontal interference can usually be corrected by adjusting the PHASE (OSD menu).
Vertical interference can usually be corrected by adjusting the FREQUENCY (OSD menu).

DEW CONDENSATION BEHIND GLASS:

Note that this problem will not occur on bonded products. For non-bonded products, do the following:
Power on the TFT product and set brightness to 100%. Turn off any automatic screensavers on PC or similar. During minutes the dew will be gone. To speed up the process, use a fan heater for a reasonable time. Do not overheat the unit.

HATTELAND TECHNOLOGY

an EMBRON Company 

Declaration of Conformity

We, manufacturer, **Hatteland Technology AS**, Eikeskogvegen 52, N-5570 Aksdal, Norway

declare under our sole responsibility that the
JH MMD, JH MMC, JH STD, JH MIL, HM NMD, HM MIL, HM CMD, HT STD, HD MMD, HD MVD, HM MMD, HM XRD,
HM RMD, HT MMC, HD MMC and HT/HM (computers) product ranges is in conformity with the following standards in
accordance with the EMC Directive.

Low Voltage Directive 2014/35/EU
EN 60950:2006/A2:2013
EMC Directive 2014/30/EU
EN 55032:2012 Class A / AC:2011 Class A
EN 55024:2010

Signature:.....

Frode Grindheim
Vice President Product Management
Aksdal, Norway



CE MARK FIRST AFFIXED DATE (11 March 2010)

Signature:.....

Arne Kristiansen
Site Manager - Test & Commission Division
Oslo, Norway

Declaration of Conformity

We, manufacturer, **Hatteland Technology AS**, Eikeskogvegen 52, N-5570 Aksdal, Norway
declare under our sole responsibility that the JH MMD, JH MMC, JH STD, JH MIL, HM NMD, HM MIL, HM CMD, HT STD,
HD MMD, HD MVD, HM MMD, HM XRD, HM RMD, HT MMC, HD MMC and HT/HM (computers) product ranges is in
conformity with IEC 60945 4th (EN 60945:2002) and IACS E10 (where applicable)

HATTELAND TECHNOLOGY

an EMBRON Company 

Declaration of Conformity

We, manufacturer, **Hatteland Technology AS**, Eikeskogvegen 52, N-5570 Aksdal, Norway

declare under our sole responsibility that the products listed below comply with
FCC 47 CFR Part 15, Subpart B, Class A:

JH MMD, JH MMC, JH STD, JH MIL, HM NMD, HM MIL, HM CMD, HT STD, HD MMD, HD MVD, HM MMD, HM XRD,
HM RMD, HT MMC, HD MMC and HT/HM (computers) product ranges

Note: This equipment has been tested and found to comply with the limits for a Class A digital device, pursuant to part 15 of the FCC Rules.
These limits are designed to provide reasonable protection against harmful interference when the equipment is operated in a commercial
environment. This equipment generates, uses, and can radiate radio frequency energy and, if not installed and used in accordance with the
instruction manual, may cause harmful interference to radio communications. Operation of this equipment in a residential area is likely to
cause harmful interference in which case the user will be required to correct the interference at his own expense.

Signature:.....

Frode Grindheim
Vice President Product Management
Aksdal, Norway



FCC MARK FIRST AFFIXED DATE (16 February 2012)

Signature:.....

Arne Kristiansen
Site Manager - Test & Commission Division
Oslo, Norway

Return Of Goods Information

Return of goods:

(Applies not to warranty/normal service/repair of products)

Hatteland Technology referenced as “manufacturer” in this document.

Before returning goods, please contact your system supplier before sending anything directly to manufacturer. When you return products after loan, test, evaluation or products subject for credit, you must ensure that all accessories received from our warehouse are returned. This applies to cables, powermodules and additional equipment except screws or similar, user manual, datasheets or other written paper documents. Furthermore, the product must not have any minor / medium or severe scratches, chemical spills or similar on the backcover, front frame or glass.

This is required in order to credit the invoice 100%. Missing parts will not be subject for credit, and you will not get total credit for returned product. You will either be charged separately, or the amount is withdrawn from the credit. If you decide to ship the missing items later on, you will get 100% credit for that particular invoice or items received at manufacturer incoming goods control. Please contact our service/sales department if additional questions or review the following links at bottom of page for more information online.



Handling and packing units for return/credit

To prevent damage during shipping and transportation, respect the guidelines below.

Make sure you surround the product with the following material (whenever possible):

Use the original packaging from manufacturer, firm foam material, bubble wrap, lots of PadPack paper or foam chips/polyester wrapped in sealed plastic bags. Please make sure that the unit is protected with a surrounding plastic bag to prevent dust accumulation around the unit.

If you do not have the original packaging or are uncertain as to how to secure the unit properly, please consider seeking advice from nearby shipping or transportation offices, if in doubt!

Do not under any circumstances use loose foam chips, expanded polyester, clothes, cardboard with sharp edges/spikes, too little or nothing to secure the unit inside the box. Do not use cardboard boxes that are clearly too weak or not suitable for securing the unit properly during overseas shipment.

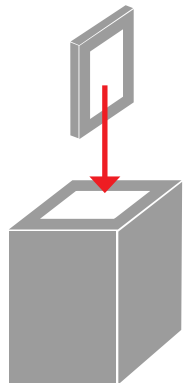

Reference Links:

<http://lcm.hatteland-display.com/CustomerrMA/CustomerrMA.aspx>

<https://www.hattelandtechnology.com/rma-procedure>

<https://www.hattelandtechnology.com/legal-documents>

General Terms and Conditions

As of January 2015, Hatteland Technology AS' "Terms of Sales and Delivery" and "Warranty Terms" have been substituted by the updated "General terms and conditions for sale of goods and performance of additional services" (the "General Terms and Conditions").

Further, from January 2015 onward, the previous "Terms of Sales and Delivery" and "Warranty Terms", as well as other standard terms and conditions, policies and instructions issued by Hatteland Technology AS, will be removed from the User Manuals.

Instead, the updated General Terms and Conditions and the other standard terms and conditions, policies and instructions issued by Hatteland Technology AS will be available via our website only.

Please visit <https://www.hattelandtechnology.com/legal-documents#terms-and-conditions> to review the latest revision

Long Term Storage Recommendations

For Minimum storage life for Hatteland Technology products, Storage Conditions, Periodic maintenance - test procedure, please visit:

https://www.hattelandtechnology.com/hubfs/pdf/misc/ind100350-5_long_term_storage_recommendations.pdf

INSTRUCTIONS FOR THE CONSIGNEE

1) CONTROL

Control the goods immediately by receipt. Examine the quantity against the invoice/packinglist/shipping documents. Look for outward defects on the packing which may indicate damage on or loss of contents. Control the container and the seals for any defects.

2) SECURING EVIDENCE

When defects on the goods have been found, evidence must be secured, and seller must be informed. Call the transporter and point out the defects. Add a description of the defects on the goods receipt, the forwarder's copy of the way-bill or on the driving slip.

3) RESCUE

Try to restrict the damage and the loss. Seller will compensate expenses incurred due to reasonable security efforts in addition to damage and loss.

4) COMPLAINT

Immediately write a complaint to the transporter or his agent. Immediately forward the complaint to the transporter or his agent, and hold the transporter responsible for the defects. The complaint must be sent at the latest:

- for carriage by sea: within 3 days
- for overland / air transportation within 7 days

5) DOCUMENTATION

For any claims the following documentation is required and must be forwarded to the company or their agent: invoice, way-bill and/or bill of landing, and/or statement of arrival, inspection document, besides a copy of the letter of complaint to the transporter.

Pixel Defect Policy

PIXEL DEFECT POLICY

Dot-defects (Bright or dark spots on the panel)

Due to the effect that dot failures are part of the TFT technology such failure occurrence cannot be prevented basically. Even though dot defects usually occur during production process, new defects can appear within the lifespan of a TFT display. Neither the production at LCD-supplier nor the use of an LCD-Monitor after shipment can be influenced by Hatteland Technology. Hence Hatteland Technology cannot be made responsible for such dot failures. However Hatteland Technology understands and accepts the responsibility towards the customers for the delivery of new displays, therefore accepts a limitation on dot defects occurrence on new displays delivered to the customer.

PRINCIPLES

- a. One pixel consists of 3 dots (Red, Green and Blue)
- b. Dot defects are differentiated between:
 - Bright dot defects: Spot on the panel appear as pixels or sub pixels that are always lit. Non-extinguishing dot.
 - Dark dot defects: Spot on the panel appear as pixels or sub pixels that are always dark (off). Non-lightening dot.
- c. Inspector observes the LCD from normal direction at a distance of 50cm above the worktable. Dark dots are counted under entire white screen. Bright dots are counted under entire black screen.
- d. Dot failures within tolerances below do not qualify for warranty claims.

PIXEL DEFECT TOLERANCES

Bright dot	≤ 4 dots
Two adjacent bright dots *	≤ 2
Distance between 2 dot defects *	≥ 15 mm
Dark dots	≤ 8
Total number of bright or dark dot defects. *	≤ 8

* 1 or 2 adjacent dot defects considered as 1 defect.

EXTRAORDINARY CIRCUMSTANCES

Possible cases which cannot be influenced either by customer or Hatteland Technology.

Examples for extraordinary circumstances:

- Allocation from LCD-Supplier
- Outstanding high number of LCD-panels with bright dots but within LCD-suppliers Specification.
- Sharply increased demand by customer

In such cases a mutual agreement is inevitable.

Examples:

- Acceptance of bright dots in "non-critical" display areas.
- Acceptance of bright dots with defined color.

Last Revised April 2019

Link to online resource:

https://www.hattelandtechnology.com/hubfs/pdf/misc/ind100351-1_pixeldefectpolicy.pdf

General Notes:

- The unit is tested according to IEC 60945 4th (EN 60945:2002), 4.4, equipment category b) "protected from the weather (formerly class B)".
- Other type approvals applies for the different products.
Please see the appropriate "Specifications" page in this manual for more information.
- Use of brilliance and Glass Display Control™ (touch key functions) may inhibit visibility of information at night.

Revision History

Rev.	By	Date	Notes
00_01	WJ SE	09 Jun 2017	Release for internal review.
00_02	SE	15 Jun 2017	Added Panel Gaskets
00_03	KK WJ SE	18 Aug 2017	Revised after internal review, added HB models and more accessories
01	WJ KKK BB JE FG SE	23 Oct 2017	Final version 01 for internet release Note: Address changed from "Stokkastrandvegen 87B, N-5578 Nedre Vats" to "Eikeskogvegen 52, N-5570 Aksdal" throughout the manual, reference: http://www.hatteland-display.com/mails/26_2017_pr.html
02	KKK BB PL SE	29 Nov 2017	Added JH 26TAP STD-A1 accessory, page 137 Revised Contents of Package, note "Q1/2018" for HD CMB SX2-E1 / -F1 throughout the manual General update throughout the user manual based on latest specifications and company profile
03	FG SE	20 Dec 2017	Revised "Service Mode OSD", removed "362" wrong code + added note, page 50, 66 General updates performed throughout the user manual based on latest specifications and company profile.
04	VM SE	13 Feb 2018	Removed references to HD CMB SX1-B1 and HD CMB-SX1-C1, now replaced by HD CMB SX2-E1 and HD CMB SX2-F1. Revised Swap Source, only available for PIP, page 61, 65
05	BB FG SE	19 Feb 2018	Corrected errors in Contents of Package (DP cable removed, VGA cable added), page 5
06	BB SE	26 Mar 2018	Revised Contents of Package (USB cable), page 9
07	VM WJ SE	08 May 2018	Revised text for "SCOM+Touch" added mention of USB, page 49, 58, 70
08	BB WJ SE	29 Jun 2018	Added new HD VED SX2-I1, -J1, -K1 drawings & specs., page 86,87,88,89,125,126,127 - Ref: http://www.hatteland-display.com/mails/12_2018_ecn.html
09	LS KK JK SE	06 Aug 2018	Revised Panel Cutout for 19 inch, page 84,85,96,97
10	WJ LS HAB YG BB SE	15 Oct 2018	Added HD 26TAP SX1-A1, page 132 Revised HD CMB SX2-E1, F1 description and drawings throughout the manual Removed HD VED SX2-H1 throughout the manual (now obsolete) - Ref: http://www.hatteland-display.com/mails/12_2018_ecn.html General updates performed throughout the entire manual after internal reviews
11	BB SE	28 Nov 2018	Added HD CAK SX2-A1, HD CAK SX2-B1 accessories, page 86,87,89,139,140
12	VM KKK SE	17 Dec 2018	Revised Hot-key details, page 65 Revised HD CAK SX2-A1, HD CAK SX2-B1 drawings, page 141,142
13	VM SE	04 Jan 2019	Changed "Disable" to "Enable", page 72
14	MS SE	27 Feb 2019	Adjusted text for PIP CHILD, PIP SPLIT, PIP WIDE, page 60
15	YS KKK VM SE	29 Mar 2019	Revised with updated drawings for 24 inch High Bright model, page 101 Revised Touch Screen Drivers information, page 18 Added detection time between sources, longest time, page 51,52,61
16	SE	01 Aug 2019	Updated with latest company profile, revised various grammar, several improvements performed through the entire user manual

Revision History

17	ALL SE	02 Dec 2019	Removed Global and Documentation Driver DVD from Contents of Package, page 8, ref: https://www.hatteland-display.com/mails/20_2019_eol.html Adjusted OSD menus according to: https://www.hatteland-display.com/mails/13_2019_ecn.html Several corrections regarding OSD Menu modes/header made throughout the OSD Menu chapter Replaced P007032-1 Gasket 24" with P022211, page 9,146 Added information about "UHF Protection", page 67
18	VM SE	03 Feb 2020	Replaced DDC/CI Chapter with the appropriate section intended for Series X G2 MMD models, page 78-80
19	VM SE	05 Feb 2020	Added reserved function "Spectrum Mode", page 49,67 Revised "Keep OCM Mode" function description, page 43, 67 -ref: https://www.hattelandtechnology.com/product-notifications/firmware-update-affecting-series-x-g2-mmd-displays-15-to-27-inch
20	VM SE	08 May 2020	Added PIP valid combination table, page 61 Revised text and illustration for Terminal Block connection, page 28 General maintenance performed throughout the entire manual and specifications pages
21	VM HS SE	06 Jan 2021	Added details for OSD Key Outdoor mode regarding UHF, page 68, 156,157 Ref: https://www.hattelandtechnology.com/product-notifications/series-x-g2-maritime-multi-display-mmd-firmware-update https://www.hattelandtechnology.com/product-notifications/series-x-g2-maritime-multi-display-mmd-firmware-update-24_2020_ecn General maintenance performed throughout the entire manual and specifications pages



HATTELAND TECHNOLOGY

an EMBRON Company 