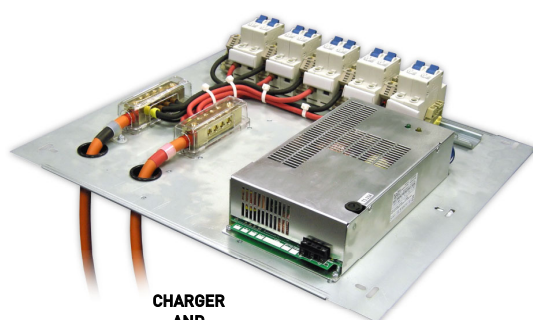
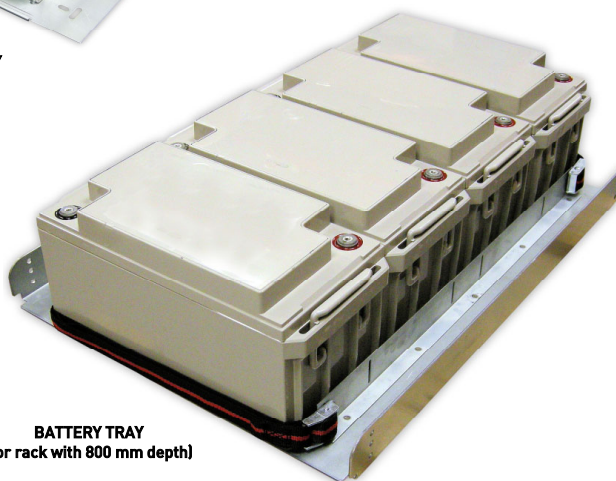


## BPC130 / BDIST / MDIST

### Battery Pack, Charger, Battery and Mains Distribution



**CHARGER  
AND  
BATTERY DISTRIBUTION TRAY**



**BATTERY TRAY  
(for rack with 800 mm depth)**

## Product Manual

ASL Document Ref.: U-0456-0145.doc  
Issue: 04 complete, approved - Date: 25/10/11



This equipment is designed and manufactured to conform to the following EC standards:

EMC: EN 61000-6-4:2007, EN 61000-6-2:2005, EN 50121-4:2006,  
EN 61000-4-13:2002, ENV 50204:1995, EN 50130-4:1996

Safety: EN 60950-1:2006 (pollution degree 2)

Voice Alarm: When installed in a Voice Alarm system designed in accordance with the ASL EN 54-16 & ISO 7240-16 System Design Guide (T-0667-0016) and configured as described in its user documentation, this equipment meets the requirement of EN 54-16:2008, ISO 7240-16:2007, BS 5839-8:2008, EN 54-4:1997, EN 54-4:1997/A1:2002 and EN 54-4:1997/A2:2006.

A 'Declaration of Conformity' statement to the above standards, and a list of auxiliary equipment used for compliance verification, is available on request.

Failure to use the equipment in the manner described in the product literature will invalidate the warranty.



This product must be disposed of in accordance with the WEEE directive.

Copyright © 2011 Application Solutions (Safety and Security) Limited

Application Solutions (Safety and Security) Limited

Unit 17 Cliffe Industrial Estate

Lewes - East Sussex

BN8 6JL - UK

Tel: +44(0)1273 405411

Fax: +44(0)1273 405415

[www.asl-control.co.uk](http://www.asl-control.co.uk)



QUALITY ASSURED FIRM  
CERTIFICATE NUMBER 96-LON-AQ-041

All rights reserved.

Information contained in this document is believed to be accurate. However, no representation or warranty is given and Application Solutions (Safety and Security) Limited assumes no liability with respect to the accuracy of such information.

## Contents

1	Overview .....	5
2	Operation .....	7
2.1	Controls .....	7
2.2	Indicators.....	7
3	Installation.....	8
3.1	Equipment and Tool Requirements .....	8
3.2	Cabling Requirements.....	8
3.3	Main Components.....	9
3.4	Recommended Installation Procedure .....	9
3.4.1	Battery Backup System Installation – Rack with 800 mm Depth .....	10
3.4.1.1	Installing the Battery Tray and Batteries.....	10
3.4.1.2	Installing the Charger Tray and Charger .....	12
3.4.1.3	Connecting the Power Distribution (BDIST) .....	14
3.4.1.4	Connecting the Batteries.....	15
3.4.1.5	Fitting the Front Panel .....	15
3.4.1.6	Powering the system up.....	16
3.4.1.7	Commissioning the Battery Backup System at the Router .....	16
3.4.2	Battery Backup System Installation – Rack with 600 mm Depth .....	17
3.4.2.1	Installing the Battery Tray and Batteries.....	17
3.4.2.2	Installing the Charger Tray and Charger .....	18
3.4.2.3	Connecting the Power Distribution (BDIST) .....	18
3.4.2.4	Connecting the Batteries.....	19
3.4.2.5	Fitting the Front Panel .....	20
3.4.2.6	Powering the system up.....	20
3.4.2.7	Commissioning the Battery Backup System at the Router .....	20
3.4.3	MDIST Installation .....	20
4	Connection Diagram .....	21
5	Commissioning .....	22
5.1	Obtaining the Router’s Contact .....	22
5.2	Configuring the Router Contact for Fault Reporting .....	22
5.3	Configuring the Fault Text .....	24
5.4	Configuring the Fault Type.....	24
6	Fault Finding.....	25
7	Maintenance .....	27
7.1	Visual Inspection .....	27
7.2	Resistance Measurement.....	27
7.3	Battery Replacement .....	28
7.3.1	800 mm Deep Rack .....	28
7.3.2	600 mm Deep Rack .....	29
8	Product Specification.....	30
9	Mechanical Dimensions.....	32
10	Safety and Precautions.....	35
10.1	Handling .....	35
10.2	Installation .....	35
10.3	Weight Safety.....	35
10.4	Environmental.....	35
10.5	Electrical Safety .....	35
10.6	Fire / Burn Safety .....	36
10.7	Battery Disposal.....	36

10.8	Unpacking and Handling .....	36
10.9	Packing for Return for Repair .....	36
11	Reference Documents .....	37

# 1 Overview

The BPC130 is a 19" rack mounting self-contained 24 V DC battery backup system for use with ASL Voice Alarm systems. It is designed to comply with EN 54-16, ISO 7240-16 and BS 5839-8.

The BPC130 is for use on 230 V AC mains supply and provides 130Ah of battery capacity with a 6.5 A recharge rate. The battery system features temperature compensation of the charge voltage to maximise battery life. The unit is fully monitored to the requirements of EN 54-4 and BS 5839-8 and provide fault-reporting outputs for direct connection to the Voice Alarm Router<sup>1</sup>.

Eight BDIST 25 A and two BDIST 3 A outputs are provided. The BDIST (Battery Distribution) comprises all of the required connectors and miniature circuit breakers. The 25 A outputs are normally used for connecting ASL Amplifier Mainframes<sup>2</sup>. The 3 A outputs are used with low current 24 V DC powered equipment such as the ASL VA Routers. Various battery power distribution cable assemblies are available from ASL for connecting the relevant equipment.

The BPC130 battery system for racks with 800 mm depth is comprised of one charger tray, one battery tray and four 6 V batteries<sup>3</sup>; see Figure 1 (page 6). It requires 8U rack space.

The BPC130 battery system for racks with 600 mm depth is comprised of one charger tray, two battery trays and four 6 V batteries<sup>3</sup>. It requires 13U rack space.

The charger tray is designed to fit into racks with 600 mm or 800 mm depth. The battery tray is available for a variety of 19" rack types. As additional rack types are regularly added, check with ASL for current availability on any given rack type.

The MDIST (Mains Distribution) provides all of the required components for mains distribution from a 32 A rack input to the required number of outputs. All outputs are 10 A IEC320-IEC320 leads which are primarily designed for connection to an ASL Amplifier Mainframe but are also suitable for other equipment.



A variety of factors need to be carefully considered when designing battery backup systems for Voice Alarm applications. To assist in this process, a battery requirements calculator is available from the ASL's website at [www.asl-control.co.uk](http://www.asl-control.co.uk).



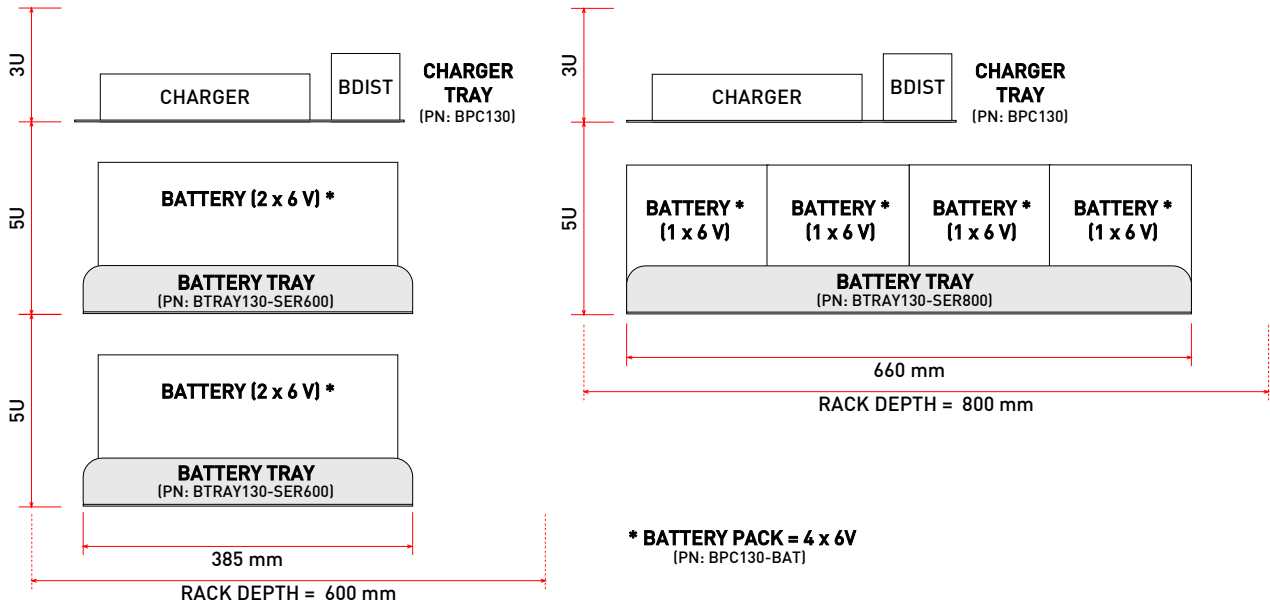
At the time of the publication of this manual, only the BPC130 battery system for Schroff 800 mm Eurorack is EN54-16 and EN 54-4:1997+A1:2002+A2:2006 certified. Please refer to ASL for further details.

<sup>1</sup> The VA Router can be any ASL rack mounted Voice Alarm and Public Address system: VAR4, VAR12, VAR20, VAR8, or VAR8-ACU

<sup>2</sup> ASL Amplifier Mainframes: V400, X400, iPA400-DC and iPAM400

<sup>3</sup> Refer to the Product Specification (page 31) for part numbers.

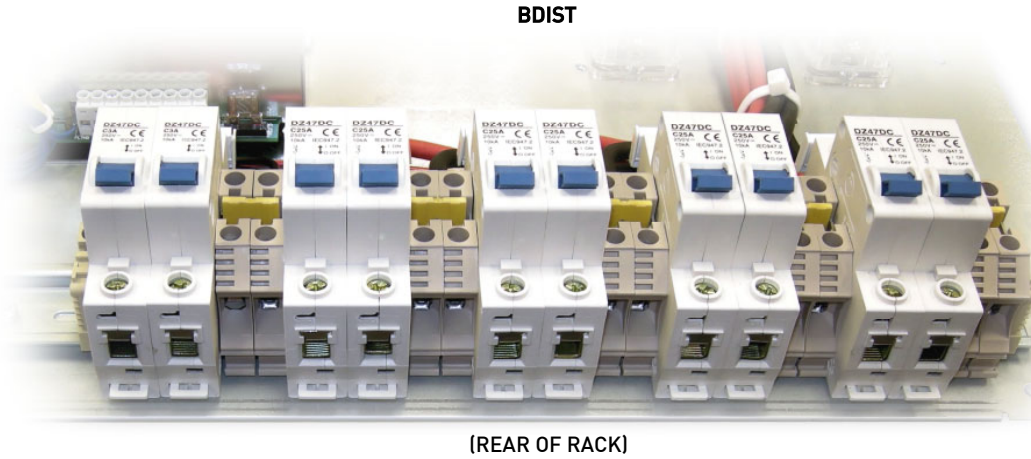
**Figure 1** BPC130 charger tray and battery tray layout



## 2 Operation

### 2.1 Controls

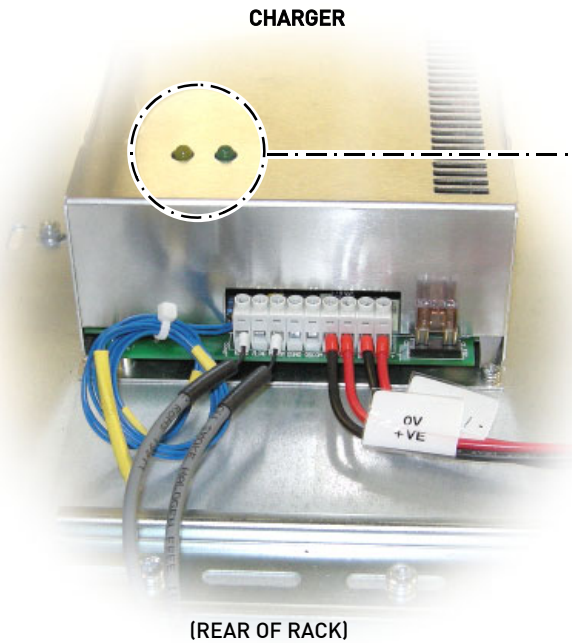
Figure 2 BDIST Mini Circuit Breakers



**BDIST:** The battery outputs are connected/disconnected to/from the systems by Miniature Circuit Breakers (MCB) provided with the BDIST at the rear of the charger tray.

### 2.2 Indicators

Figure 3 Charger indicators



LED	Status	Indication
Power (green)	ON	Mains is present
	OFF	Mains not present
Fault (yellow)	OFF	No fault
	Single flash repeated at regular interval	Mains or charger fail
	Two flashes repeated at regular interval	Incorrect output voltage
	Three flashes repeated at regular interval	High battery resistance fault
	Four flashes repeated at regular interval	Battery missing or reverse battery
	Continuously ON	Microprocessor fail


## 3 Installation

### 3.1 Equipment and Tool Requirements

- BPC130 charger tray, battery tray(s), battery pack and front panels
- BDIST cable assembly of suitable size for all rack battery power feeds
- MDIST of suitable size for all rack mains feeds
- Flat-bladed screwdriver (small and medium)
- Pozidriv screwdrivers (1, 2 and 3)
- Wire cutters and strippers
- Ferrules and crimping tool
- AF spanner with insulated handle for 6 mm nuts
- AF spanner for 4 mm nuts
- A 19-inch standard rack fitted with supporting rails and wired with power supply, signal, and control wiring, as required by your specific system design

### 3.2 Cabling Requirements

Signals	Cable Description	Termination	Suggested Type
Mains supply	1 x 3-core mains cable	Suitable ferrules	Suitably rated standard mains cable
Mains distribution	IEC-IEC 10 A mains lead	<ul style="list-style-type: none"> <li>• Amplifier Mainframe end: IEC320-C13 (female)</li> <li>• MDIST end: IEC320-C14 (male)</li> </ul>	ASL MDIST4, MDIST6 or MDIST8 cable assembly
Battery distribution (for high current equipment, e.g. Amplifier Mainframes)	1 x 1-core red 1 x 1-core black	<ul style="list-style-type: none"> <li>• Amplifier Mainframe end: 7W2 mixed signal D connector (female)</li> <li>• BPC130 end: suitable ferrules</li> </ul>	ASL BDIST4-CA, BDIST6-CA or BDIST8-CA cable assembly
Battery distribution (for low current equipment, e.g. Routers)	1 x 2-core cable	<ul style="list-style-type: none"> <li>• VAR4/12/20 end: 2-way pluggable Wago cage clamp terminal (male)</li> <li>• VAR8/VAR8-ACU end: suitable ferrules</li> <li>• BPC130 end: suitable ferrules</li> </ul>	Suitably rated 2-core cable
Fault relay	1 x 2-core cable	<ul style="list-style-type: none"> <li>• VAR4/12/20 end: standard 25-way D connector (male)</li> <li>• VAR8/VAR8-ACU end: suitable ferrules</li> <li>• BPC130 end: suitable ferrules</li> </ul>	Suitably rated 2-core cable

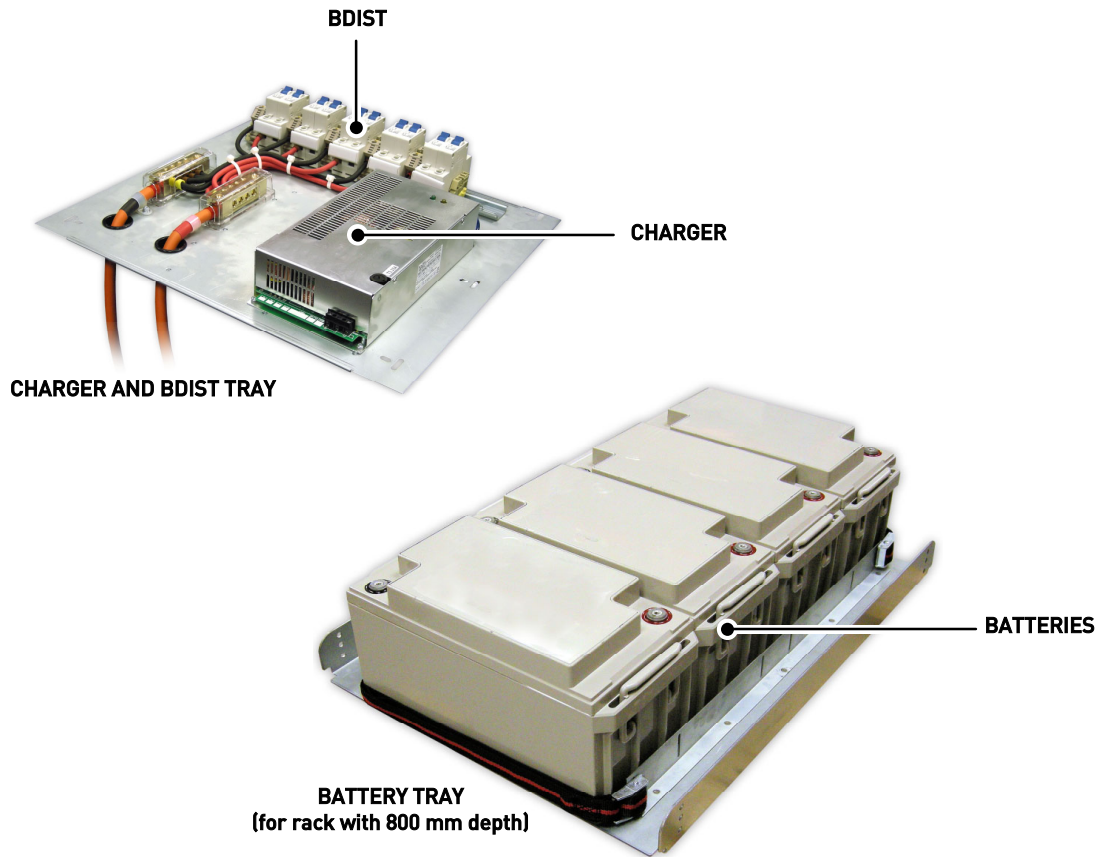


Refer to BS7671:2008 (Requirements for Electrical Installations) or other appropriate local standards for guidelines on maximum potential cable lengths given the actual installation parameters.



### 3.3 Main Components

**Figure 4** BPC130 components (rack with 800 mm depth as example)



### 3.4 Recommended Installation Procedure



- 1) Please read and observe the instructions and guidelines in Section “Safety and Precautions” (page 35) prior to installation. Failure to follow these instructions and guidelines may cause personal injury and/or damage to the equipment.
- 2) Use suitable ferrules for all terminal block connections.
- 3) This equipment is intended for use in a restricted access location.
- 4) To prevent injury, the battery backup system must be securely attached to the rack in accordance with these installation instructions.

### 3.4.1 Battery Backup System Installation – Rack with 800 mm Depth

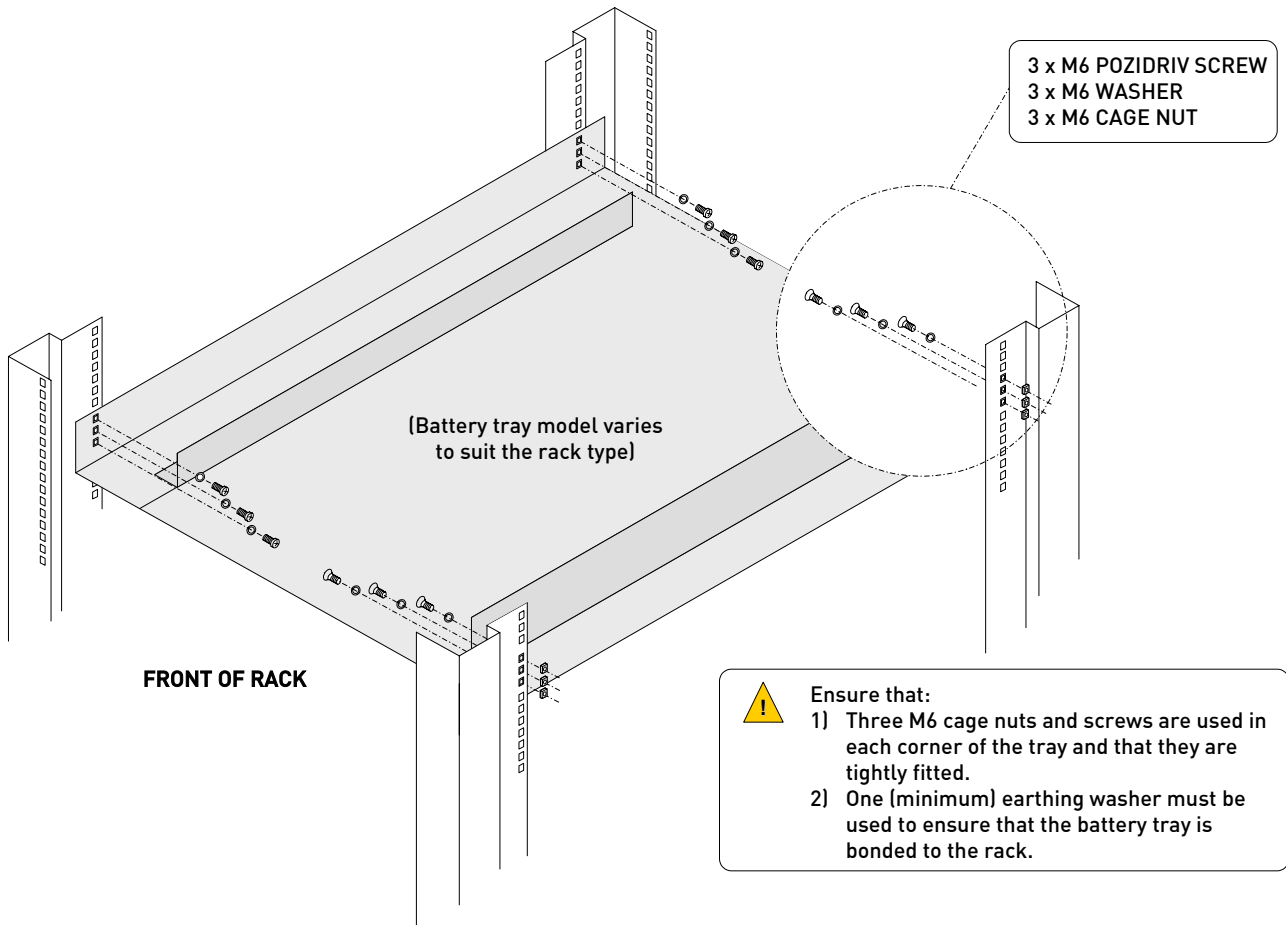


- 1) Ensure that all safety precautions detailed in Section “Safety and Precautions” (page 35) are taken.
- 2) Note the correct polarity when connecting the interlink cable(s):  
**Red band terminal=Positive and Black band terminal=Negative.**
- 3) For all cable connections use the terminal screws supplied with the batteries and ensure that they are sufficiently tight.

#### 3.4.1.1 Installing the Battery Tray and Batteries

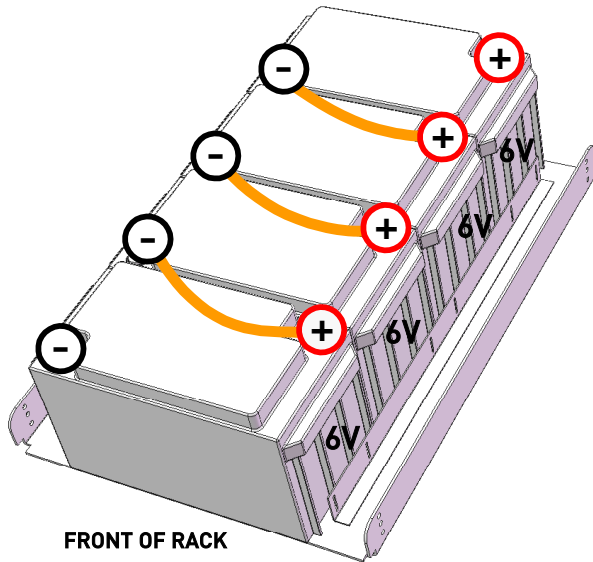
1. Fit the battery tray to the rack in appropriate position securing it with twelve M6 screws; see Figure 5.

**Figure 5** Installing the battery tray



- Slide the batteries into the tray and then connect the interlink cables (short) noting the layout diagram in Figure 6.

**Figure 6** Fitting the batteries into the tray and connecting the interlink cables



**!** Batteries are heavy (23 kg each). Please move and handle with care to avoid personal injuries and/or damages to the batteries.

**!** Always use insulated tools!

**!** Note the correct polarity when connecting the interlink cable(s):  
Red band terminal=positive  
Black band terminal=negative

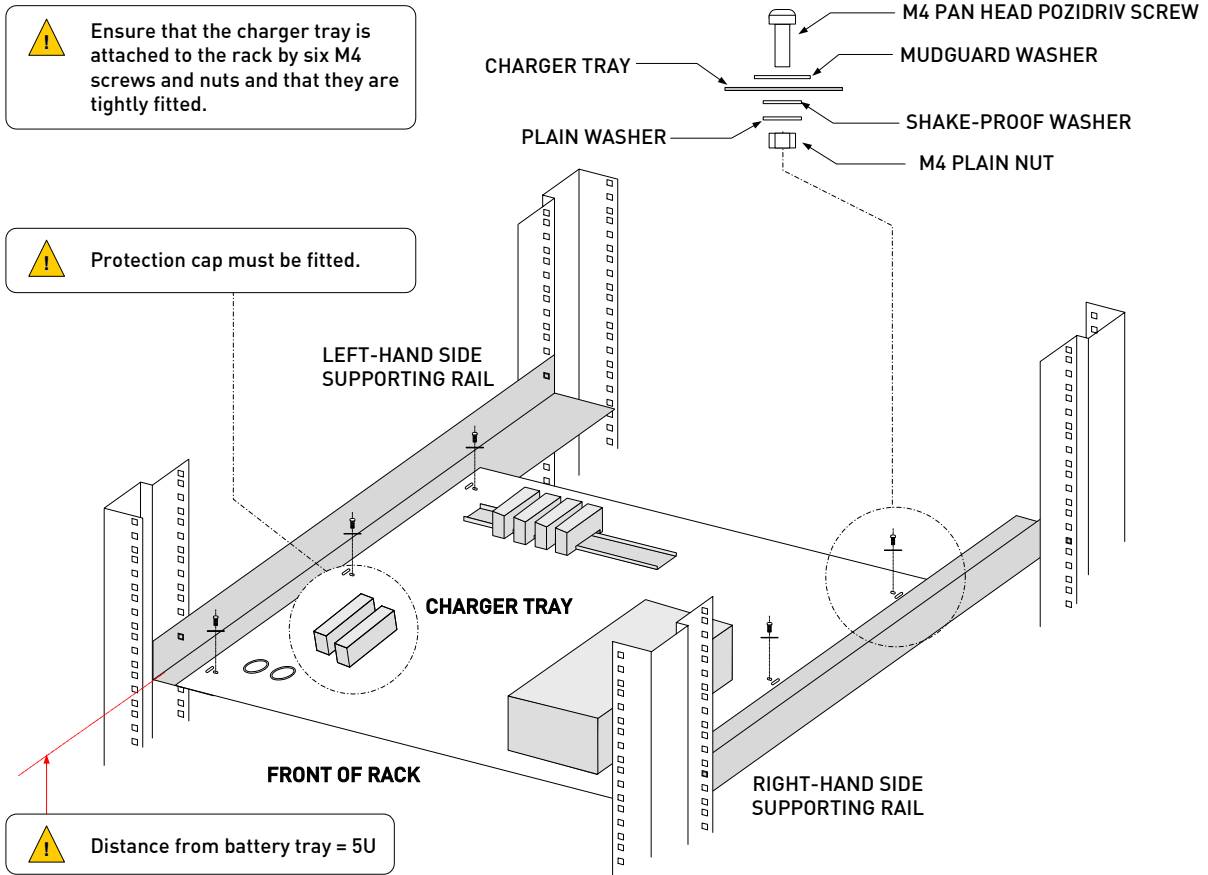
**!** Fit protective cap to battery terminals!  
(Depending on the model supplied, the battery terminal protective caps must be fitted to the lead before its connection to the battery terminal.)

- Fit a protective cap (supplied) to each of the battery terminals connected to a interlink cable.

### 3.4.1.2 Installing the Charger Tray and Charger

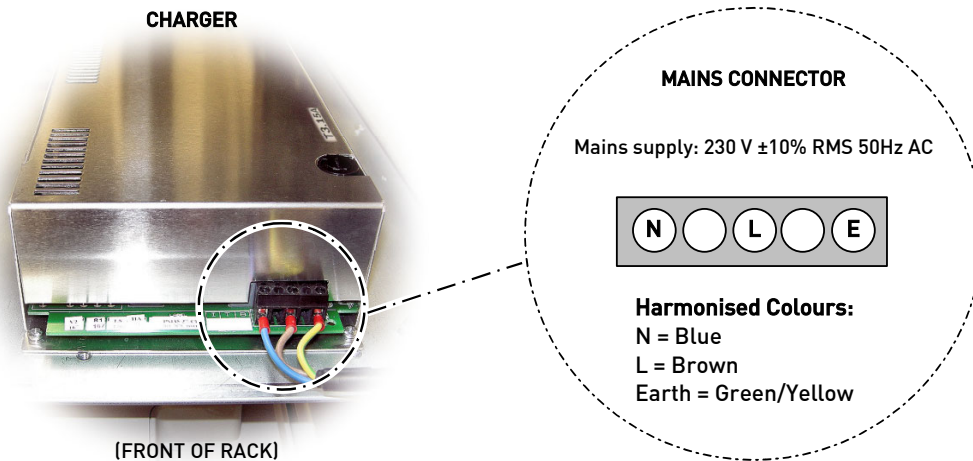
4. Ensure that the AC mains supply to the charger is isolated.
5. Install the charger tray onto the support rails securing it with the M4 screws, nuts and washers supplied; see Figure 7.

**Figure 7** Installing the charger tray




6. Connect the charger mains cable to the terminal block marked N-L-E; see Figure 8.

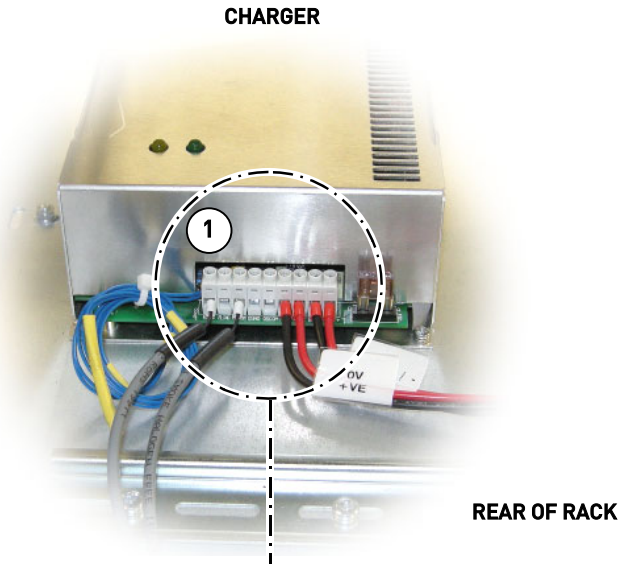
**Figure 8** Charger connections (front of rack)



7. Connect the fault relay contact of the charger to the required Router contact; see Figure 9

 Check the system design documentation for connection details.

**Figure 9** Fault relay contacts (rear of rack)



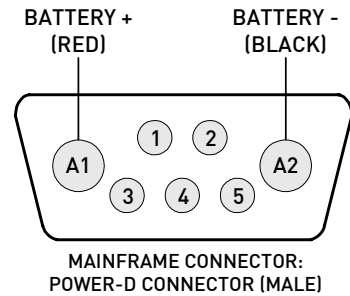
Terminal	Signal	Description	
1	FLTNO	Fault relay N/O contact	Volt-free relay contact (for connection to any available Router contact)
2	FLTNC	Fault relay N/C contact	Not used
3	FLTCOM	Fault relay COM contact	Volt-free relay contact (for connection to 0 V from the Router)
4	OSNO	DC power available relay N/O contact	Volt-free relay contact (not used)
5	OSCOM	DC power available relay COM contact	
6	0V	Auxiliary DC power supply output: 0V wiring (black)	Wired at manufacture to +BATT&-BATT lead pair
7	+V	Auxiliary DC power supply output: +VE wiring (red)	
8	-BT	Battery connection -BATT wiring (black)	Wired at manufacture to +VE&0V lead pair
9	+BT	Battery connection +BATT wiring (red)	

### 3.4.1.3 Connecting the Power Distribution (BDIST)

8. Ensure that all 24 V Mini Circuit Breakers are switched OFF (switch toggle towards the rear of the rack).
9. ASL BDISTx-CA cable assemblies are cut to length and terminated with a suitable ferrule on one end and a Power-D connector on the other end for connection to an ASL Amplifier Mainframe.

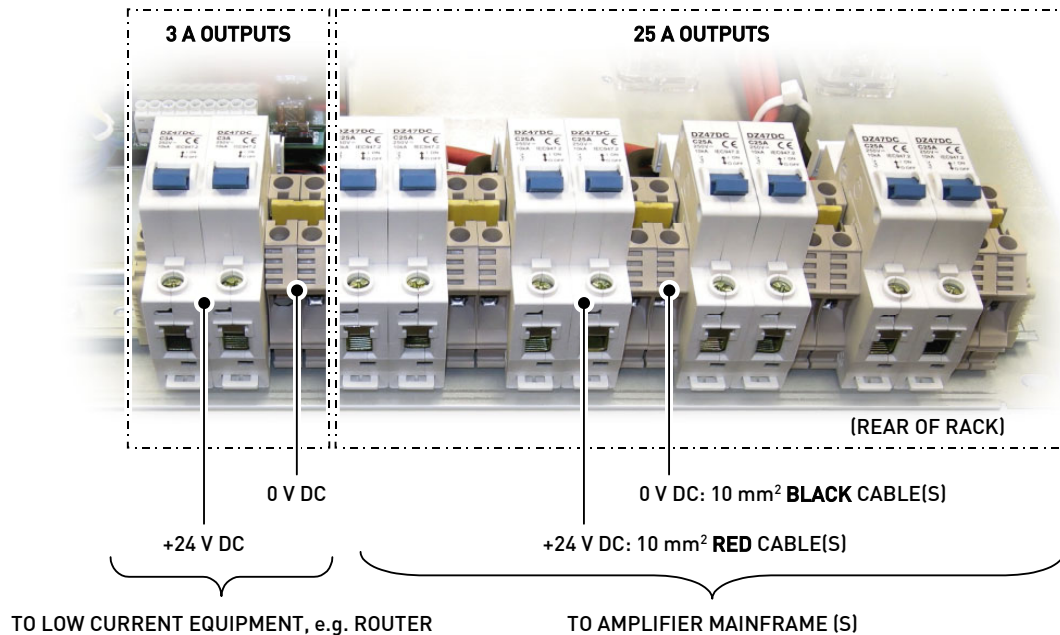
Note that the Amplifier Mainframes must be fitted into the rack according to the ASL rack layout specification; please refer to ASL for details.

10. If assembling the 25 A distribution cable, then terminate one end of the red and black cable to the Power-D connector for connection to an ASL Amplifier Mainframe (see diagram on the right).




11. Cut the other end of the 10 mm<sup>2</sup> red and black cable to length, and terminate it with a suitable ferrule.
12. Fit the Power-D connector to the related ASL Amplifier Mainframe using the jackscrews provided.
13. Connect the other end of the red cable to a free 25 A MCB output at the BDIST; see Figure 10.
14. Connect the other end of the black cable to a free terminal at the BDIST; see Figure 10.

Figure 10 BDIST connection



15. If the 3 A output is used, then cable any required low current equipment to the 3 A output(s) terminating the BDIST end of the cable with a suitable ferrule; see Figure 10.



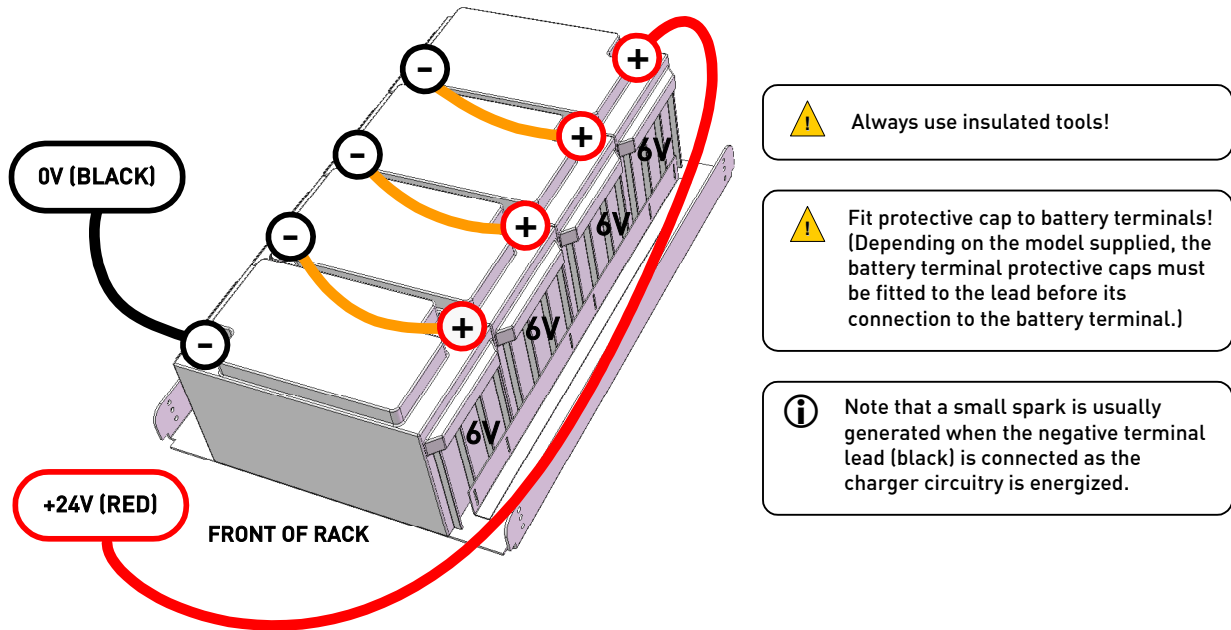
- 1) Note correct polarity at the BDIST:  
MCB output = +24 V DC  
Adjacent terminal = 0 V DC
- 2) Ensure that the 3 A current limit will not be exceeded in use.

16. Ensure that all cables are tied back neatly and clear from any sharp edges or other risk of chafing.

### 3.4.1.4 Connecting the Batteries

17. Pass the red terminal lead from the charger through the cable hole down to the battery tray, and then connect it to the right-hand battery positive terminal at the rear of the rack; see Figure 11.
18. Pass the black terminal lead from the charger through the cable hole down to the battery tray, and then connect it to the left-hand battery negative terminal at the front of the rack; see Figure 11.

Figure 11 BPC130 terminal lead connection



19. Fit a protective cap (supplied) to each of the battery terminals.
20. Secure the batteries in position using the strap(s) fitted to the battery tray see Figure 12.

Figure 12 Securing the batteries (front of rack)



### 3.4.1.5 Fitting the Front Panel

21. After batteries have been installed and commissioned, fit all front panels using M6 cage nuts, screws and nylon washers.
22. Fit the supplied caution label to the appropriate front panel.

#### **3.4.1.6 Powering the system up**

- 23.** Connect the AC mains supply to the charger.
- 24.** Wait for the batteries to fully charge (24 hours) and then switch the Mini Circuit Breakers on as required.

#### **3.4.1.7 Commissioning the Battery Backup System at the Router**

- 25.** Commission the BPC130 as described in Section “5 Commissioning” (page 22).



### 3.4.2 Battery Backup System Installation – Rack with 600 mm Depth

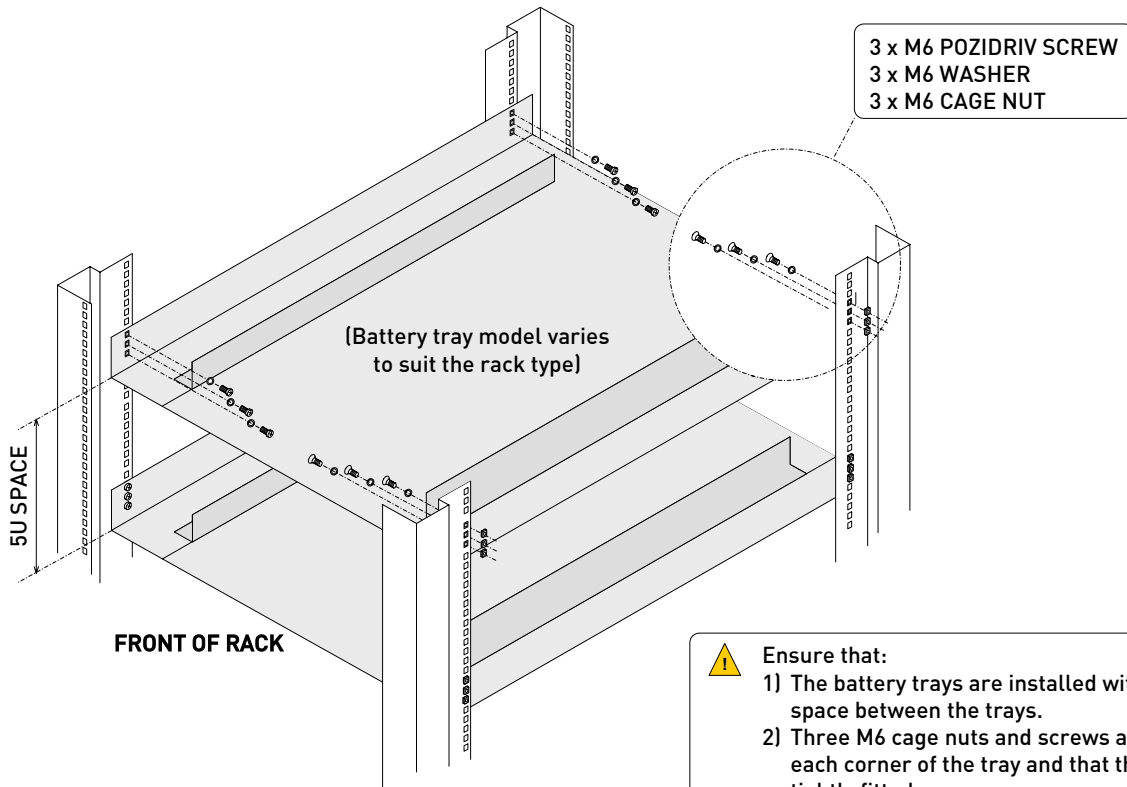


- 1) Ensure that all safety precautions detailed in Section “Safety and Precautions” (page 35) are taken.
- 2) Note the correct polarity when connecting the interlink cable(s):  
**Red band terminal=Positive and Black band terminal=Negative.**
- 3) For all cable connections use the terminal screws supplied with the batteries and ensure that they are sufficiently tight.

#### 3.4.2.1 Installing the Battery Tray and Batteries

1. Ensure that the AC mains supply to the charger is isolated.
2. Fit the battery trays to the rack in appropriate positions securing it with twelve M6 screws; see Figure 13.

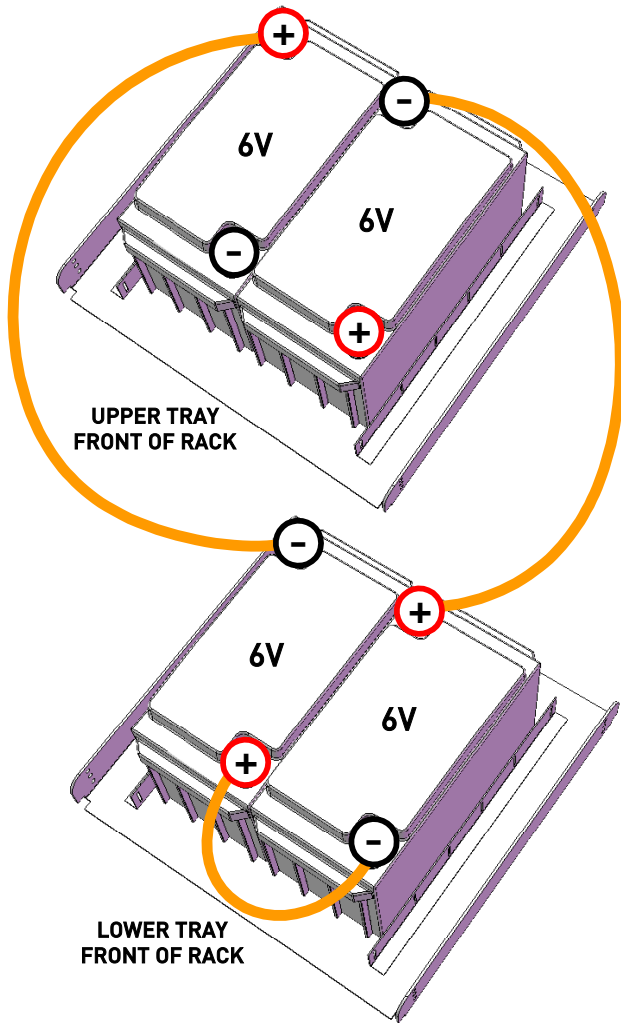
**Figure 13** Installing the battery tray



- !** Ensure that:
- 1) The battery trays are installed with 5U space between the trays.
  - 2) Three M6 cage nuts and screws are used in each corner of the tray and that they are tightly fitted.
  - 3) One (minimum) earthing washer must be used to ensure that the battery tray is bonded to the rack.

3. Slide two batteries into each of the battery trays noting the layout diagram in Figure 14.
4. Connect the rear interlink cables (long) and the front interlink cable (short) to both pairs of batteries as shown in Figure 14.

**Figure 14** Fitting the batteries into the tray and connecting the interlink cables



**!** Batteries are heavy (23 kg each). Please move and handle with care to avoid personal injuries and/or damages to the batteries.

**!** Always use insulated tools!

**!** Note the correct polarity when connecting the interlink cable(s):  
Red band terminal=positive  
Black band terminal=negative

**!** Fit protective cap to battery terminals!  
(Depending on the model supplied, the battery terminal protective caps must be fitted to the lead before its connection to the battery terminal.)

5. Fit a protective cap (supplied) to each of the battery terminals connected to a interlink cable.

### 3.4.2.2 Installing the Charger Tray and Charger

Refer to Section “3.4.1.2 Installing the Charger Tray and Charger” (page 12).

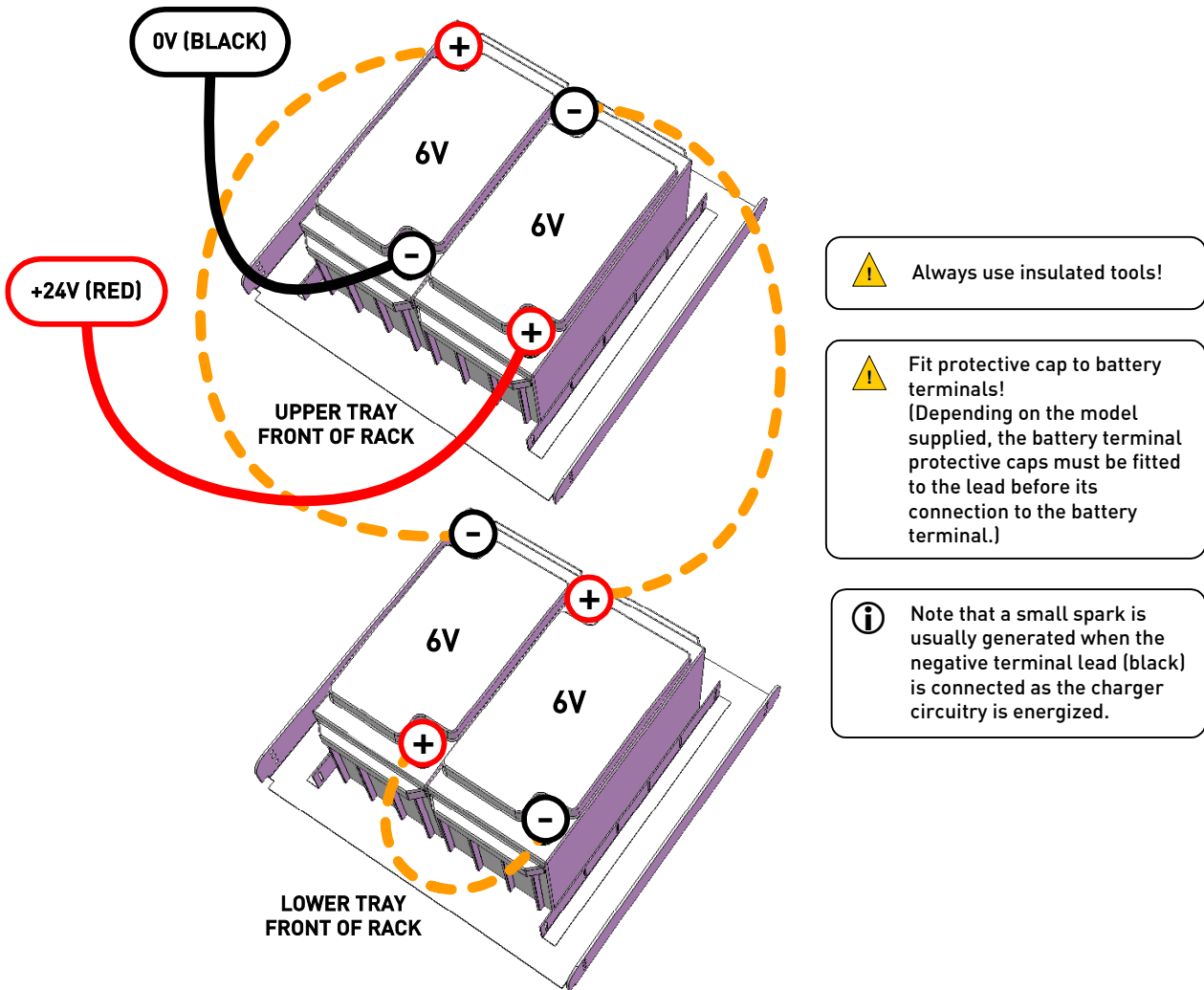
### 3.4.2.3 Connecting the Power Distribution (BDIST)

Refer to Section “3.4.1.3 Connecting the Power Distribution (BDIST)” (page 14).

### 3.4.2.4 Connecting the Batteries

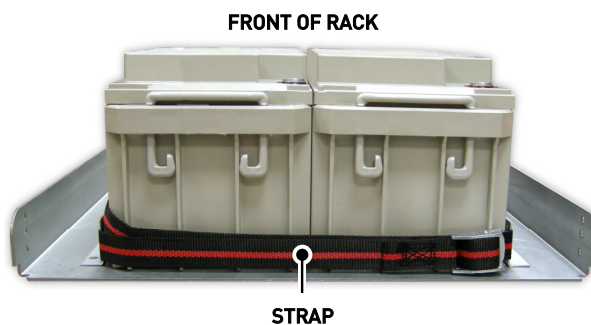
6. Pass the red terminal lead from the charger through the cable hole down to the upper battery tray, and then connect it to the right-hand positive battery terminal at the front of the rack; see Figure 15.
7. Pass the black terminal lead from the charger through the cable hole down to the upper battery tray, and then connect it to the left-hand negative battery terminal at the front of the rack; see Figure 15.
8. Fit a protective cap (supplied) to each of the battery terminals.

Figure 15 BPC130 positive terminal lead connection



9. Secure the batteries in position using the straps fitted to each battery tray; see Figure 16.

Figure 16 Securing the batteries (front of rack)



#### 3.4.2.5 Fitting the Front Panel

10. After batteries have been installed and commissioned, fit all front panels using M6 cage nuts, screws and nylon washers.
11. Fit the supplied caution label to the appropriate front panel.

#### 3.4.2.6 Powering the system up

12. Connect the AC mains supply to the charger.
13. Wait for the batteries to fully charge (24 hours) and then switch the Mini Circuit Breakers on as required.

#### 3.4.2.7 Commissioning the Battery Backup System at the Router

14. Commission the BPC130 as described in Section “5 Commissioning” (page 22).

### 3.4.3 MDIST Installation



MDIST comprises a distribution block and a number of IEC320-IEC320 leads with lengths to suit ASL rack layout specification; please refer to ASL for details.

1. Ensure that the AC mains supply to the MDIST is isolated.
2. Fit the incoming mains cable through the gland and connect it into the terminal block inside the end of the distribution block.

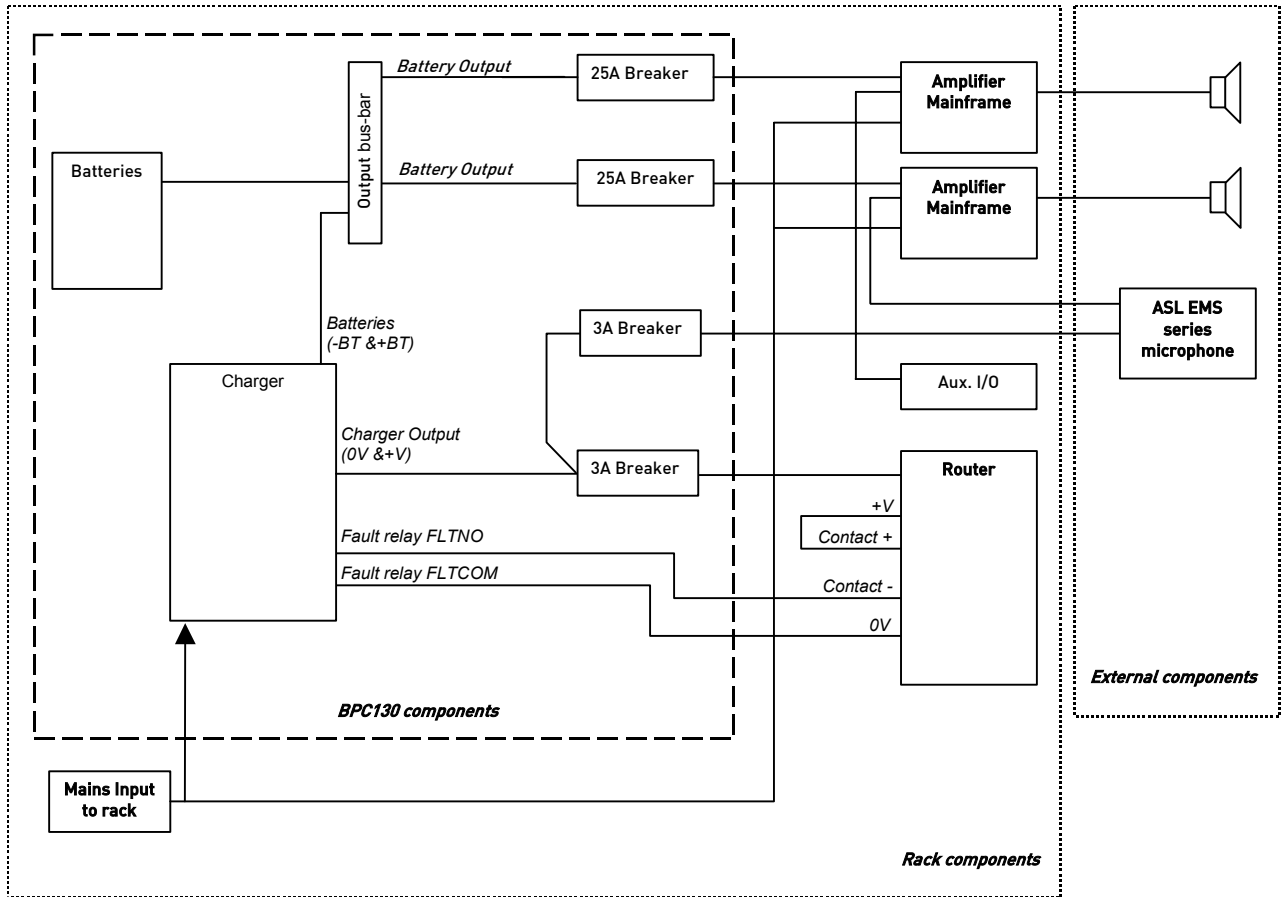


- 1) Ensure that the incoming mains cable is suitably rated for the load.
- 2) Ensure that the gland and terminals are tightly fitted.

3. The MDIST distribution block should be mounted behind the charger tray using the fixings provided.
4. Ensure that the earth strap provided on the distribution block is connected to the rack.
5. Connect all required IEC320-IEC320 leads between the distribution block and equipment.
6. Ensure that all cables are tied back neatly and clear from any sharp edges or other risk of chafing.
7. Connect the AC mains supply to the MDIST.

## 4 Connection Diagram

Figure 17 Connection diagram



**i** Fault Relay: connect to any available Router contact. For further details, refer to the Router user documentation.

## 5 Commissioning



The following details are correct for the VAR4/12/20 Router, VAR8, and VAR8-ACU software versions at the time of publication:

- VAR4/12/20 Router:
  - Master board (Board 0): CP<sup>1</sup> V6.1.0010 or later / DSP V4.1.0688 or later
  - Slave board (Board 1 and 2): CP V6.1.0002 or later DSP V3.2.0213 or later
- VAR8: CP V3.1.0010 or later / DSP V3.0.0415 or later
- VAR8-ACU: CP V3.1.0006 or later / DSP V3.0.0415 or later

If any difficulties are encountered, then refer to ASL for advice, quoting the software versions of your system.

The software versions are displayed via the following menu option:

- VAR4/12/20: **Configuration→System→Misc→Software**
- VAR8/VAR8-ACU: **Config→System→Misc→Software**

For details refer to your system specific documentation available from ASL's website: [www.asl-control.co.uk](http://www.asl-control.co.uk)

Configure the fault reporting of the battery backup system from the Router Configuration Tool, or from the system front panel as described in the following sections. Note that Access Level 3 is required for configuration tasks.

### 5.1 Obtaining the Router's Contact



Check the system design documentation to find the Router contact being used to report the battery backup system fault.

### 5.2 Configuring the Router Contact for Fault Reporting

VAR4/12/20 Menu: **Configuration→System→Router→Control→Contacts→<Contact #nn>→External Fault**

VAR8/VAR8-ACU Menu: **Configuration→System→Router→Ctrl→Contacts→<Digital #nn>**

**→External Fault**

Possible values:

- 'Not Conf'
- 'Routing'
- 'Fault Accept'
- 'Fault Clear'
- '{Route Reset}'
- '{Music Select}' (VAR4/12/20 only)
- 'Global Silence' (VAR8-ACU only)

System default configuration: 'Not Conf'

<sup>1</sup> This is referred as the VAR Router SW version unless other code is specified, e.g., DSP SW.

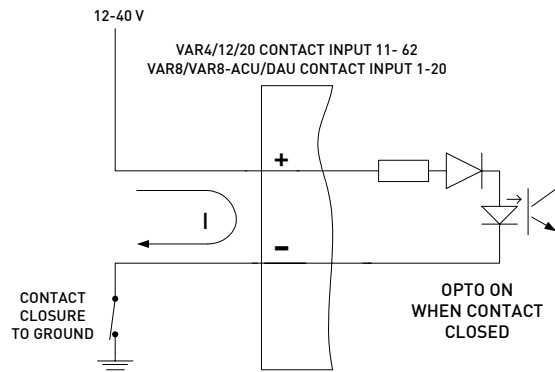
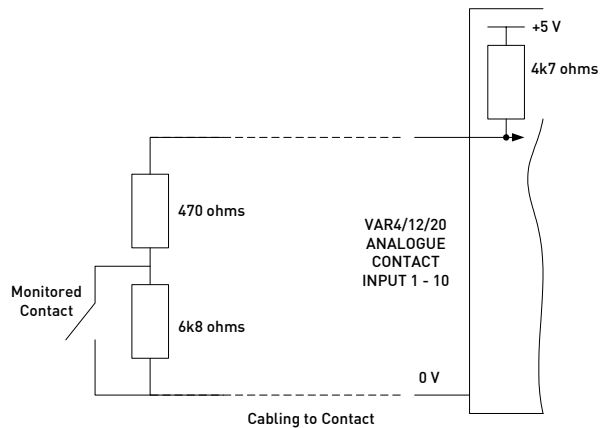
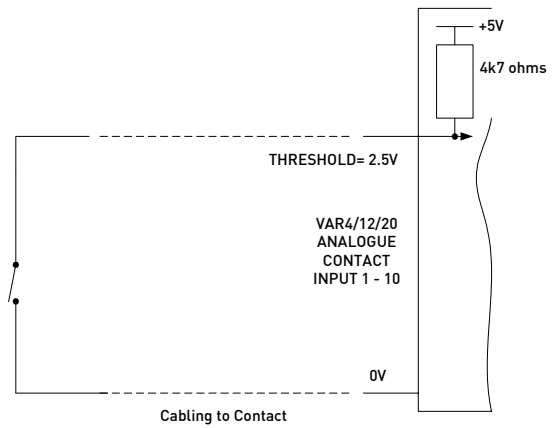
- 'unmonitored': It may be used to interface a simple contact closure to ground.

Router contacts 1 to 10 on VAR4/12/20 use a non-isolated analogue interface and operate in two modes:

- 'monitored': It may be used to interface resistively monitored contacts. The contacts must be fitted with 6k8/470R resistors.

Router contacts 11 to 62 on VAR4/12/20 and contacts 1 to 20 on VAR8 and VAR8-ACU use an opto-isolated interface.

A simple contact closure to a local or remote ground may be connected as shown.



Configure the required contact as 'External Fault'.



If an analogue contact input of a VAR4/12/20 is used, then configure the surveillance mode as required.

VAR4/12/20 Menu: **Configuration**→**System**→**Router**→**Control**→**Contacts**→<Contact #*nn*>→**Not Surv**

Possible values: 'Not Surv' (unmonitored)  
'Surv' (monitored)

System default configuration: 'Not surv'

## 5.3 Configuring the Fault Text

VAR4/12/20 Menu: **Configuration**→**System**→**Router**→**Control**→**Contacts**→<Contact #*nn*>  
→**External Fault**→**Description**

VAR8/VAR8-ACU Menu: **Configuration**→**System**→**Router**→**Ctrl**→**Contacts**→<Digital #*nn*>  
→**External Fault**→**Desc.**

Possible values: 'EXT FAULT'

System default configuration: 'EXT FAULT' (VAR4/12/20)  
'CONTACT FAULT' (VAR8/VAR8-ACU)



For EN 54-16, ISO 7240-16 and BS 5839-8 compliance, modify the fault text to 'BATT BACKUP FAULT' or other text that identifies the fault as reported by the battery backup system.

## 5.4 Configuring the Fault Type

VAR4/12/20 Menu: **Configuration**→**System**→**Router**→**Control**→**Contacts**→<Contact #*nn*>  
→**External Fault**→**EN54 Power Fault**→**EN54 Power Fault=Yes**

VAR8/VAR8-ACU Menu: **Configuration**→**System**→**Router**→**Ctrl**→**Contacts**→<Digital #*nn*>  
→**External Fault**→**EN54 Power Fault**→**EN54 Power Fault=Yes**

Possible values: 'EN54 Power Fault=No'  
'EN54 Power Fault=Yes'

System default configuration: 'EN54 Power Fault=No'

The EN 54 Power Fault when set to 'Yes' enables the Router to indicate 'POWER' fault on the bottom line of the LCD display when the contact reports a fault.



For EN 54-16, ISO 7240-16 and BS 5839-8 compliance, set the fault type to 'EN54 Power Fault=Yes'.



## 6 Fault Finding

**Table 1** Battery backup system – VAR4/12/20

Operational Fault Symptom	Fault Description	Fault Code(s) Reported and Logged at the Router	LED Indication		LCD Bottom Line Indication	Suggested Action
			System Fault	Fault		
No immediate operational failure	A fault is present in the battery backup system	VARNN/CINXX CHARGER FAULT NN=01 to 10 (VAR ID) XX=Contact number (01 to 62) "BATT BACKUP FAULT" or as configured	OFF	ON	POWER	Check the LED indication on the Charger for fault diagnostic; see Table 3 (page 26).
No operational failure	Analogue contact input fault	VARNN/CINXX SHORT/OPEN NN=01 to 30 (VAR ID) XX=01 to 10 (VAR4/12/20 only if monitored Router contact is used)	OFF	ON	POWER	Check wiring between the Charger fault relay contact and the Router.

**Table 2** Battery backup system – VAR8/VAR8-ACU

Operational Fault Symptom	Fault Description	Fault Code(s) Reported and Logged at the Router	LED Indication		LCD Bottom Line Indication	Suggested Action
			System Fault	Fault		
No immediate operational failure	A fault is present in the battery backup system	IP<n> BATT BACKUP FAULT n=1 to 20 "BATT BACKUP FAULT" or as configured	OFF	ON	POWER	Check the LED indication on the Charger for fault diagnostic; see Table 3 (page 26).

**Table 3** Charger LED indication

LED	Status	Indication
Power (green)	ON	Mains is present
	OFF	Mains not present
Fault (yellow)	OFF	No fault
	Single flash repeated at regular interval	Mains or charger fail
	Two flashes repeated at regular interval	Incorrect output voltage
	Three flashes repeated at regular interval	High battery resistance fault
	Four flashes repeated at regular interval	Battery missing or reverse battery
	Continuously ON	Microprocessor fail

## 7 Maintenance



Please read and observe the instructions and guidelines in Section “Safety and Precautions” (page 35) before carrying out any maintenance task. Failure to follow these instructions and guidelines may cause personal injury and/or damage to the equipment.

### 7.1 Visual Inspection

A visual inspection of the batteries should be carried out at maximum intervals of three months, as part of the system maintenance schedule.

Carry out a thorough visual inspection looking for signs of corrosion on or around the batteries, signs of leakage, a cracked case or top, missing protective caps.

### 7.2 Resistance Measurement

The BPC130 charger monitors the batteries’ resistance and reports a fault when high resistance is detected (>100 mΩ) – The yellow fault LED flashes three times at regular interval.

The resistance of each battery should be measured at maximum intervals of three months, as part of the system maintenance schedule. The battery resistance can be measured with appropriate battery tester (Yuasa Battery HiTester 3554).



If you find difficulty in accessing the battery terminals, then remove the charger tray as follows:

- a. Ensure that all Mini Circuit Breakers are switched off (switch toggle towards the rear of the rack).
- b. Ensure that the AC mains supply to the charger is isolated.
- c. Disconnect the black terminal lead from the left-hand negative battery terminal as shown in Figure 18 (rack with 800 mm depth) and Figure 19 (rack with 600 mm depth).
- d. Disconnect the red terminal lead from the right-hand positive battery terminal at the front of the rack as shown in Figure 18 and Figure 19.
- e. Disconnect all wiring connected to the charger and Mini Circuit Breakers. Do not disconnect the black and red terminal leads!
- f. Remove the charger tray from the rack by undoing six M4 screws.

Once the resistance measurement has been completed:

- a. Re-fit the charger tray and reconnect all disconnected wiring following the procedure described in Section “3.4.1.1 Installing the Charger Tray and Charger” (page 12).
- b. Reconnect the AC mains supply to the charger.
- c. Switch the required Mini Circuit Breakers ON.

Battery	Resistance		
	New Value (mΩ)	Warning Zone (mΩ)	Critical Zone (mΩ)
NPL130-6	1.5-1.75	2.52	3.24

## 7.3 Battery Replacement

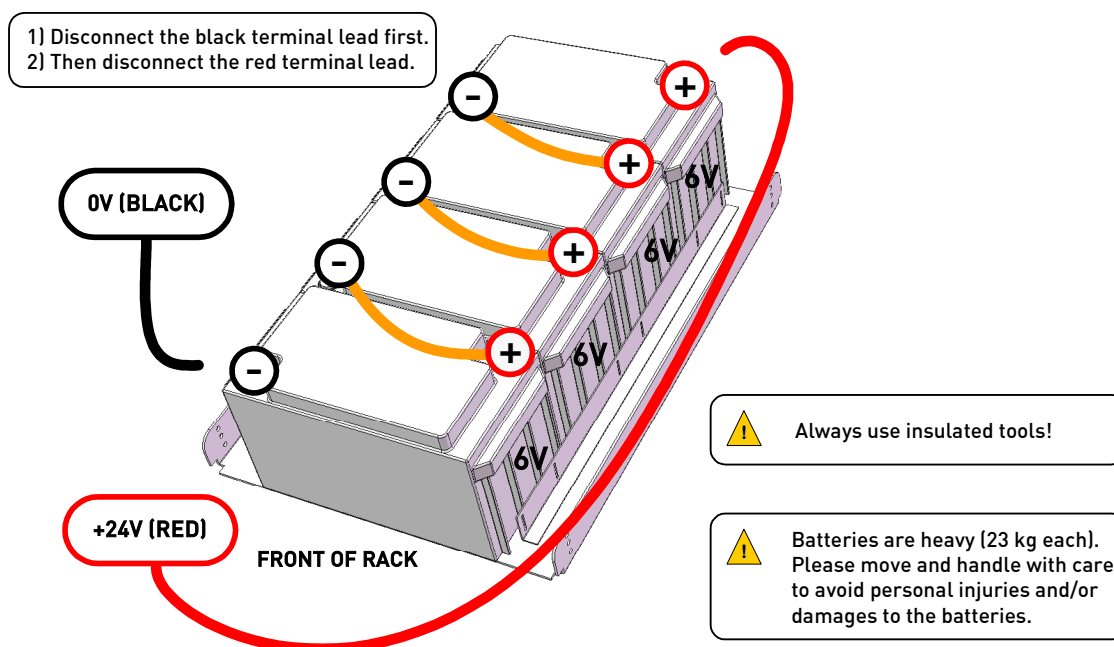


The lead-acid batteries will require replacement at maximum intervals specified by the manufacturer (typically 5 years).

### 7.3.1 800 mm Deep Rack

1. Ensure that all Mini Circuit Breakers are switched off (switch toggle towards the rear of the rack).
2. Ensure that the AC mains supply to the charger is isolated.
3. Disconnect the black terminal lead from the left-hand negative battery terminal as shown in Figure 18.

**Figure 18** BPC130 battery negative terminal disconnection

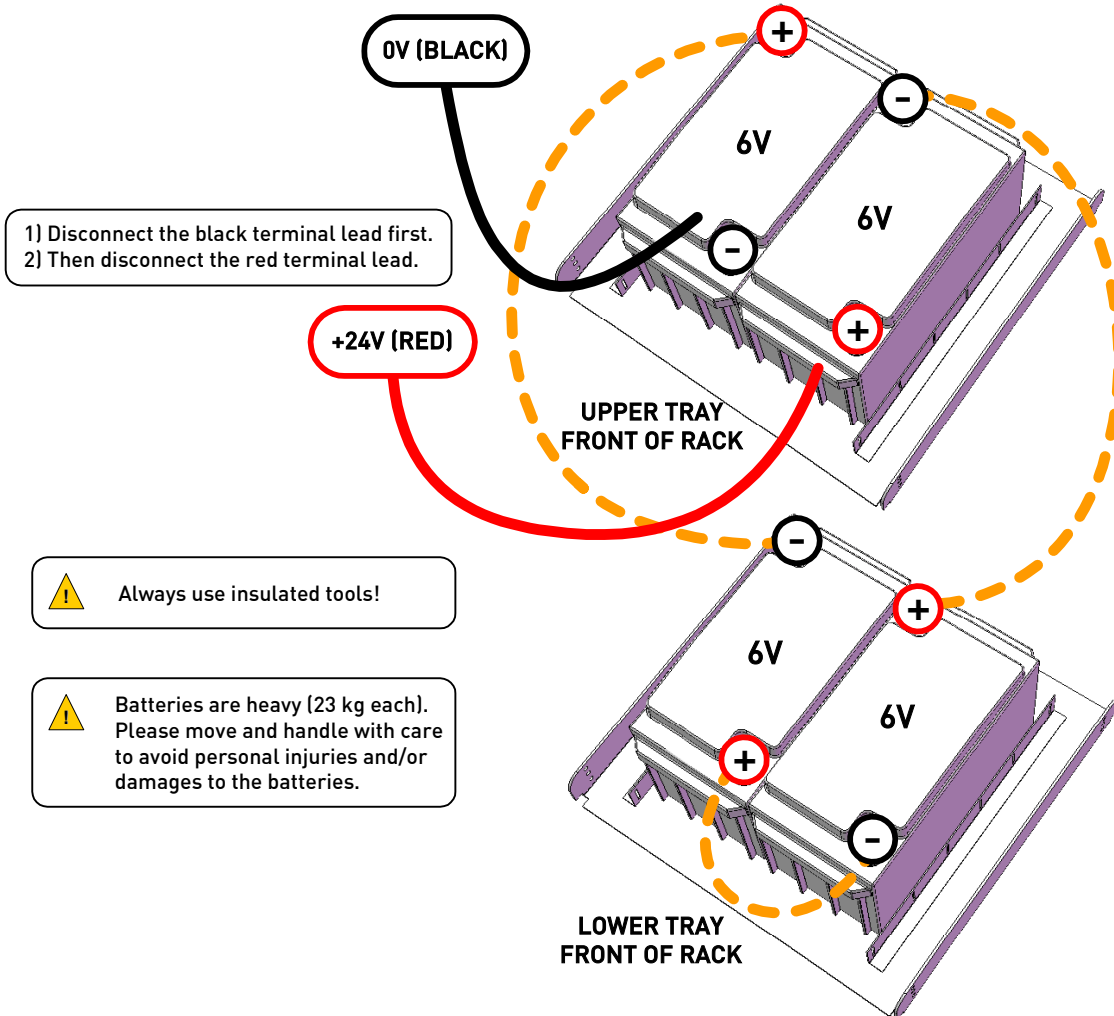


4. Disconnect the red terminal lead from the right-hand positive battery terminal at the front of the rack as shown in Figure 18.
5. Remove the charger tray as follows:
  - a. Disconnect all wiring connected to the charger and Mini Circuit Breakers. Do not disconnect the black and red terminal leads!
  - b. Remove the charger tray from the rack by undoing six M4 screws.
6. Disconnect the interlink cables and slide the batteries out of the tray.
7. Install the new batteries and charger tray as described in Section “3.4.1 Battery Backup System Installation – Rack with 800 mm Depth” (page 10).
8. Reconnect the AC mains supply to the charger.
9. Wait for the batteries to fully charge (24 hours) and then switch the Mini Circuit Breakers on as required.

### 7.3.2 600 mm Deep Rack

1. Ensure that all Mini Circuit Breakers are switched off (switch toggle towards the rear of the rack).
2. Ensure that the AC mains supply to the charger is isolated.
3. Disconnect the black terminal lead from the left-hand negative battery terminal at the front of the rack as shown in Figure 19.

Figure 19 BPC130 battery negative terminal disconnection



4. Disconnect the red terminal lead from the right-hand positive battery terminal at the front of the rack as shown in Figure 19.
5. If you find difficulty in accessing the battery terminals, then remove the charger tray as follows:
  - a. Disconnect all wiring connected to the charger and Mini Circuit Breakers. Do not disconnect the black and red terminal leads!
  - b. Remove the charger tray from the rack by undoing six M4 screws.
6. Disconnect the interlink cables and slide the batteries out of the trays.
7. Install the new batteries and charger tray (if removed) following the procedure described in Section “3.4.1 Battery Backup System Installation – Rack with 800 mm Depth” (page 10).
8. Reconnect the AC mains supply to the charger.
9. Wait for the batteries to fully charge (24 hours) and then switch the Mini Circuit Breakers on as required.

## 8 Product Specification

### BPC130

AC Supply Voltage .....	230 V $\pm$ 10% RMS 50Hz AC
In-rush Current (worst case) .....	40 A
Maximum AC VA Rating (230 V) .....	437 VA
AC Supply Fuse Rating .....	T3.15A IEC60127
Output Voltage .....	27.3 V (@ 20°C)
Charger Output Fuse Rating.....	15 A (mini blade type fuse)
Lowest voltage to which the battery can be discharged .....	21 V
Rated Continuous Maximum Output Current ( $I_{max.a}$ ) .....	3.5 A
Rated Maximum Output Current ( $I_{max.b}$ ) .....	10 A
Minimum Loading of the Equipment ( $I_{min}$ ) .....	50 mA
Maximum value of internal battery resistance for which rack functionality can be maintained ( $R_{i,max}$ ) .....	0.1 $\Omega$
Charger Output Current .....	3 A / Type C Mini Circuit Breaker
Battery Output Current .....	25 A / Type C Mini Circuit Breaker
Batteries.....	4 x Yuasa NPL130-6 (VLRA)
Charging Time .....	24 hours to charge to 100% capacity
Temperature Compensation .....	-36 mV/cell/°C
Fault Status Output (Pins 1 and 3).....	volt-free relay contacts (N/O and COM)
Overall Dimensions (H x W x D) / Weight:	
Charger and BDIST Tray.....	80 mm x 450 mm x 385 mm / 5.5 kg
Battery Tray with 4 x Batteries (for 800 mm deep rack).....	176 mm x 476 mm x 660 mm / 101.4 kg
Battery Tray with 2 x Batteries (for 600 mm deep rack).....	176 mm x 476 mm x 460 mm / 51.6 kg
Battery (Yuasa NPL130-6).....	174 mm x 350 mm x 166 mm / 23 kg

### MDIST

Operating Voltage.....	230 V $\pm$ 10% RMS 50 Hz AC
Input Current.....	32 A max
Output Current (per output) .....	10 A max

### Environmental

Temperature .....	-20°C to +50°C (storage, fully charged condition) / -10°C to +50°C (operation) (battery performance is dependent on average operational temperature; refer to manufacturer's literature)
Humidity Range .....	0% to 93% non-condensing

### Safety and EMC

EMC.....	EN 61000-6-4:2007, EN 61000-6-2:2005, EN 50121-4:2006, EN 61000-4-13:2002, EN V50204:1995, EN 50130-4:1996
Safety.....	EN 60950-1:2006 (pollution degree 2)

---

## Voice Alarm

---

When installed in a Voice Alarm system designed in accordance with the ASL EN 54-16 & ISO 7240-16 System Design Guide (T-0667-0016) and configured as described in its user documentation, this equipment meets the requirement of EN 54-16:2008, ISO 7240-16:2007, BS 5839-8:2008, EN 54-4:1997, EN 54-4:1997/A1:2002 and EN 54-4:1997/A2:2006.

At the time of the publication of this manual, only the BPC130 battery system for Schroff 800 mm Eurorack is EN54-16 and EN 54-4:1997+A1:2002+A2:2006 certified. Please refer to ASL for further details.

---

## Part Numbers

---

### Charger Tray and Battery Pack:

BPC130: 130 Ah / 10 A charger tray with +ve and –ve battery cables and circuit breakers (8 x 25A + 2 x 3 A)

### Battery Pack:

BPC130-BAT: 4 x 6 V batteries (Yuasa NPL130-6)

### Battery Trays:

BTRAY130-SER600: Battery tray for Schroff 600 mm Eurorack with battery interconnect cables and retaining strap

BTRAY130-SER800: Battery tray for Schroff 800 mm Eurorack with battery interconnect cables and retaining strap

### BDIST Battery Power Distribution Assembly (for connection to an ASL Amplifier Mainframe):

BDIST4-CA: 4-way battery power distribution cable assembly

BDIST6-CA: 6-way battery power distribution cable assembly

BDIST8-CA: 8-way battery power distribution cable assembly

### MDIST Mains Power Distribution Assembly (with 10 A IEC320-IEC320 leads):

MDIST4: 12-way 32 A PDU + 4-way mains power distribution cable assembly

MDIST6: 12-way 32 A PDU + 6-way mains power distribution cable assembly

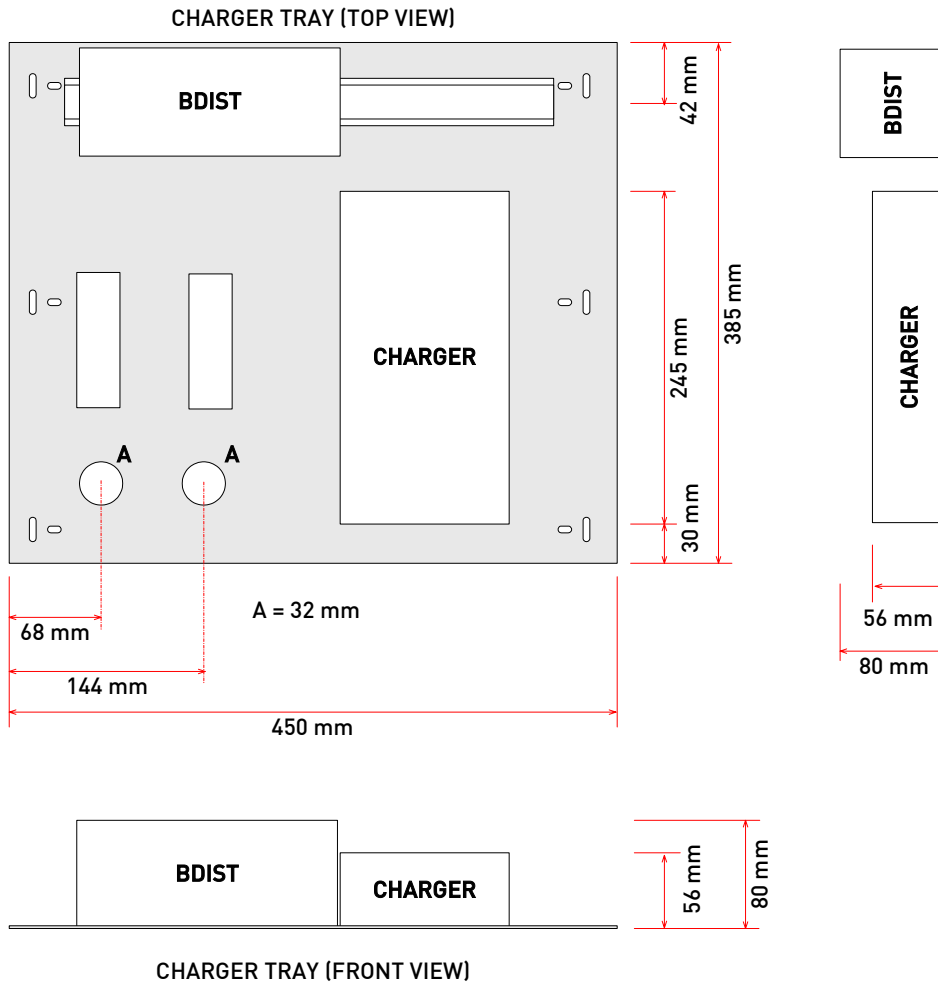
MDIST8: 12-way 32 A PDU + 8-way mains power distribution cable assembly

PDU=Power Distribution Unit

BDIST and MDIST cable lengths to suit ASL rack layout specification; please refer to ASL for details.

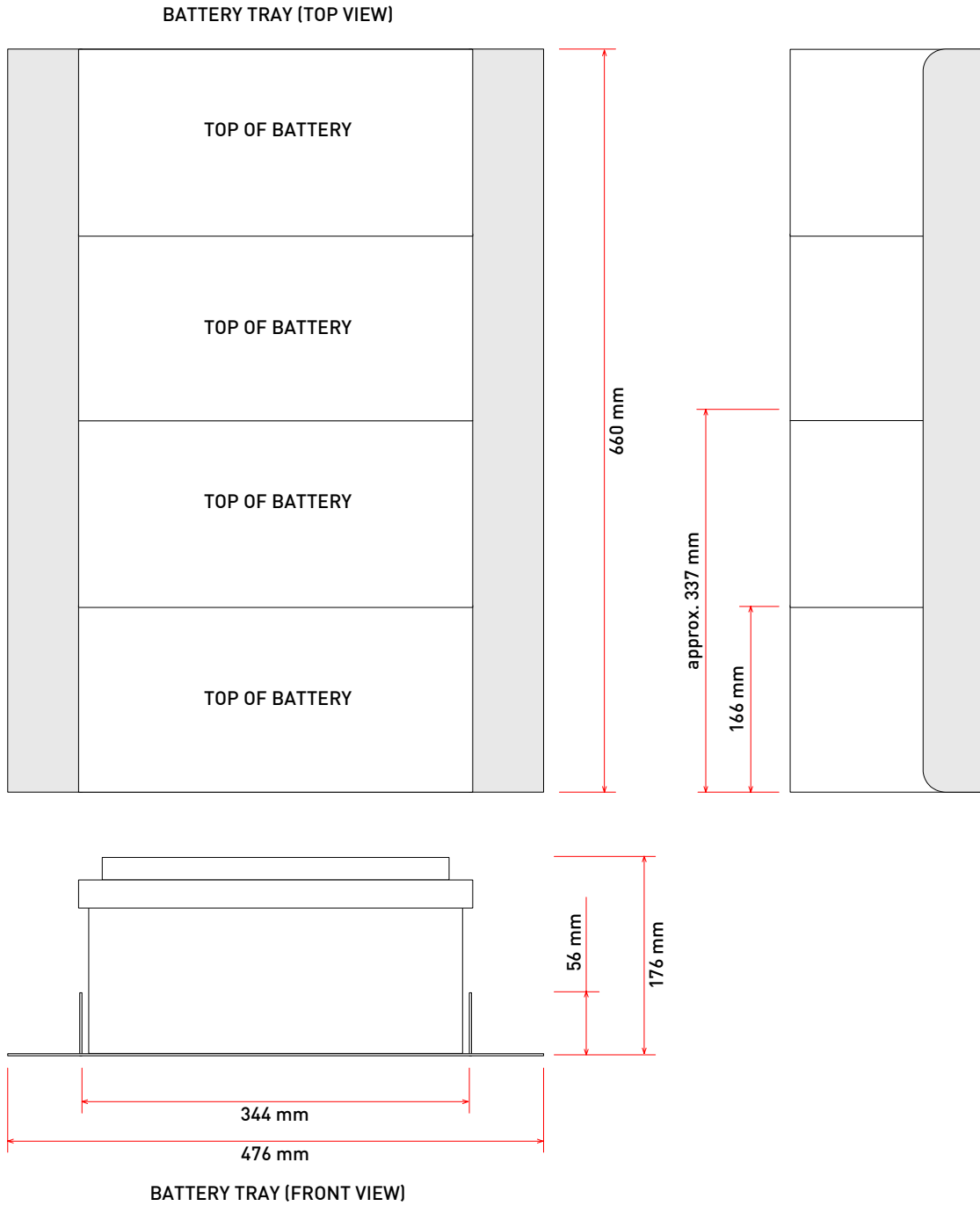
## 9 Mechanical Dimensions

Figure 20 Overall dimensions – Charger tray

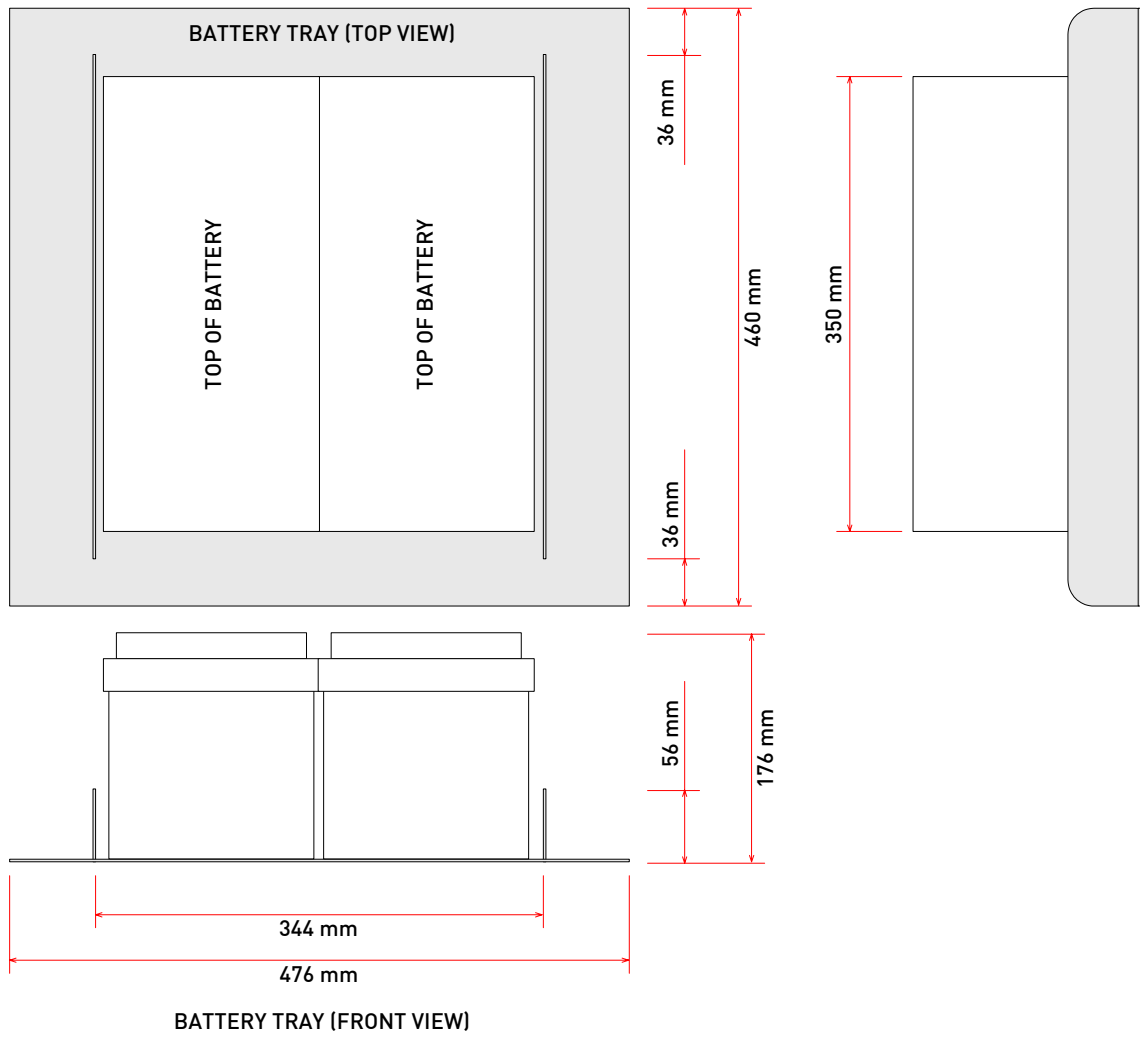




**Figure 21** Overall dimensions – Battery tray for rack with 800 mm depth



**Figure 22** Overall dimensions – Battery tray for rack with 600 mm depth



## 10 Safety and Precautions

### 10.1 Handling



Work on the batteries should be carried out by qualified personnel only.



Always use insulated tools.

### 10.2 Installation



This equipment is intended for use in a restricted access location.



To prevent injury, the battery backup system must be securely attached to the rack in accordance with the installation instructions.

### 10.3 Weight Safety



Batteries are heavy (23 kg each). Please move and handle with care to avoid personal injuries and/or damages to the batteries.

### 10.4 Environmental

Always ensure adequate ventilation of the charger module and do not obstruct ventilation holes.

The temperature and humidity ranges shown in the specifications for this product must not be exceeded.

This equipment must not be installed in an area that is subject to a corrosive atmosphere, excessive moisture or may allow water or other liquids to come into contact with the unit or its external connections.



Batteries can produce hydrogen gas under certain conditions.


Ensure that adequate ventilation is provided by the use of front vent panels and/or appropriate cabinet ventilation.

Do not use open flame or create spark near batteries at any time.

### 10.5 Electrical Safety



This product contains wiring that is energised to 230 V RMS AC mains.

Terminals marked with the  symbol are hazardous, and the external wiring connected to these terminals requires installation by qualified personnel only.



Always ensure that the equipment is correctly earthed by connection to an AC mains supply with a protective earthing connection.

Ensure power supply cabling is adequately rated for the unit's operating current and protected, in case of short circuit, by a correctly rated fuse or circuit breaker.



Note that this equipment is intended for continuous operation and as such does not contain an internal mains switch.

If this equipment forms part of a system, which is permanently connected to the mains, then an all-pole mains switch with a separation of 3 mm in each pole shall be incorporated in the electrical installation.



Always replace blown fuses with the correct type and rating.



Always ensure that all 24 V Mini Circuit Breakers are switched OFF (switch toggle towards the rear of the rack) before installing or removing batteries to/from the unit.

Do not switch any of the 24 V circuit breakers on until all batteries have been fully installed.

## 10.6 Fire / Burn Safety



Batteries contained within these units can deliver very high currents that could cause fire or burns.

Take care to avoid short-circuits of the battery terminals or connections by tools or jewellery.

Do not allow tools or unconnected cables to rest on top of batteries.

## 10.7 Battery Disposal



Lead-acid batteries contain substances harmful to the environment.

Never bury in the ground or incinerate at end-of-life.

Return all batteries to your supplier, a licensed 'spent' battery dealer or take to your Council tip for disposal.

## 10.8 Unpacking and Handling

The equipment should be unpacked and inspected immediately on receipt. If damage has occurred please advise your carrier or supplier.



This equipment contains electronic devices that are sensitive to electrostatic discharge. Please take precautions to avoid damage to the electronics by static electricity.

It is advisable to retain the original equipment packing in the event that the equipment ever needs returning for service.

Ensure that the name and address of the Authorised Distributor from whom you purchased the unit is recorded on the "Service and Warranty" page of this manual for future reference.

## 10.9 Packing for Return for Repair



All electronics assemblies must be properly packed in ESD protective packing for transport, to prevent physical and ESD damage.



The filler material used for packing for return for repair must be antistatic or static dissipative, as this may come into contact with exposed connectors, wiring, or PCB assemblies. The use of non-conductive filler material may cause damage to the electronic assemblies reducing their operational life, or even destroying them.

Advice on packing the product for return can be provided by ASL.

## 11 Reference Documents

Additional reference information is available from the ASL's website: [www.asl-control.co.uk](http://www.asl-control.co.uk)

This page intentionally left blank.

## Service and Warranty

Name and Address of Authorised Distributor:

This product carries a full warranty. For full details of warranty and service agreements, please contact the Authorised Distributor who supplied the product to you.

### Exclusions

The warranty does NOT cover:

1. Customer misuse, including incorrect installation.
2. Damage other than manufacturing defects.
3. Transit / Courier damage.
4. Incorrect voltage or power supply used.
5. Incorrect input signal.
6. Abnormal environmental operating conditions.
7. Damage incurred by accident, fire, lightning or other hazard.
8. Modification to the unit or inexpert / attempted repair.
9. No fault found – where no fault can be found after extensive testing, indicating user error or failure in ancillary equipment.
10. Electronic assemblies which are improperly packed when returned for repair or service.

Should any of the above apply, Application Solutions (Safety and Security) Limited reserves the right to raise any relevant charges to the customer.

Application Solutions (Safety and Security) Limited shall not be liable for any indirect, special or consequential loss or damage (including without limitation any loss of profits) arising from the use of this product or for any breach of this warranty.

In the interest of continual product development, Application Solutions (Safety and Security) Limited reserves the right to make changes to product specification without notice or liability.

